











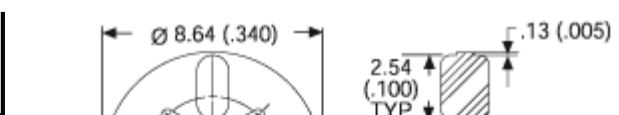
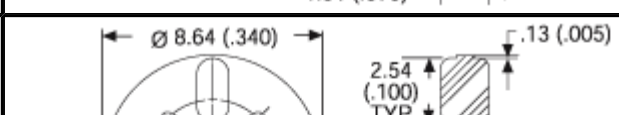





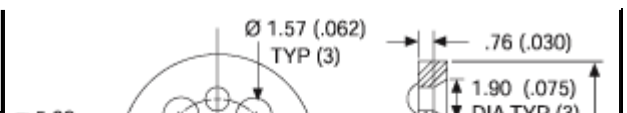

Accessories Standard Mounting Pads

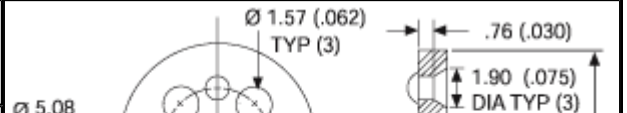
The following Mounting Pads are for use with TO-5	
7717-167DAPG RoHS Compliant	
(DAP)	
Leads: 3	
Outside Diameter mm (in): 8.71 (0.343)	
Thickness: 3.18 (0.125)	
7717-167NG RoHS Compliant	
(nylon)	
Leads: 3	
Outside Diameter mm (in): 8.71 (0.343)	
Thickness: 3.18 (0.125)	
7717-161DAPG RoHS Compliant	
(DAP)	
Leads: 4-Mar	
Outside Diameter mm (in): 8.64 (0.340)	
Thickness: 1.91 (0.075)	
7717-161NG RoHS Compliant	
(nylon)	
Leads: 4-Mar	
Outside Diameter mm (in): 8.64 (0.340)	
Thickness: 1.91 (0.075)	
7717-159NG RoHS Compliant	
(nylon)	
Leads: 5	

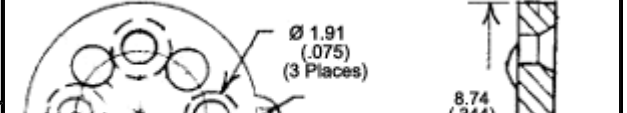
<p>Outside Diameter mm (in): 9.53 (0.375)</p> <p>Thickness: 5.59 (0.220)</p>	
<p>7717-158TG</p> <p>RoHS Compliant</p>	
<p>(Teflon)</p>	
<p>Leads: 4</p>	
<p>Outside Diameter mm (in): 9.91 (0.390)</p>	
<p>Thickness: 0.25 (0.010)</p>	
<p>7717-131DAPG</p> <p>RoHS Compliant</p>	
<p>(DAP)</p>	
<p>Leads: 4</p>	
<p>Outside Diameter mm (in): 8.89 (0.350)</p>	
<p>Thickness: 0.97 (0.038)</p>	
<p>7717-131NG</p> <p>RoHS Compliant</p>	
<p>(nylon)</p>	
<p>Leads: 4</p>	
<p>Outside Diameter mm (in): 8.89 (0.350)</p>	
<p>Thickness: 0.97 (0.038)</p>	
<p>7717-114NG</p> <p>RoHS Compliant</p>	
<p>(nylon)</p>	
<p>Leads: 4</p>	
<p>Outside Diameter mm (in): 9.02 (0.355)</p>	
<p>Thickness: 1.17 (0.046)</p>	
<p>7717-4DAPG</p> <p>RoHS Compliant</p> <p></p>	
<p>(DAP)</p>	
<p>Leads: 4</p>	
<p>Outside Diameter mm (in): 9.53 (0.375)</p>	

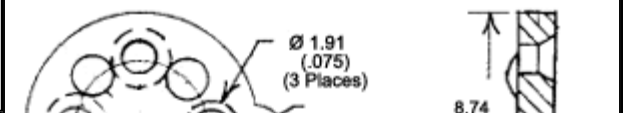
<p>Thickness: 1.91 (0.075)</p>	
<p>7717-4NG (nylon) Leads: 4 Outside Diameter mm (in): 9.53 (0.375) Thickness: 1.91 (0.075)</p>	
<p>7717-5DAPG (DAP) Leads: 4 Outside Diameter mm (in): 8.89 (0.350) Thickness: 3.18 (0.125)</p>	
<p>7717-5NG (nylon) Leads: 4 Outside Diameter mm (in): 8.89 (0.350) Thickness: 3.18 (0.125)</p>	
<p>7717-15DAPG (DAP) Leads: 4 Outside Diameter mm (in): 8.89 (0.350) Thickness: 0.51 (0.020)</p>	
<p>7717-15NG (nylon) Leads: 4 Outside Diameter mm (in): 8.89 (0.350) Thickness: 0.51 (0.020)</p>	

<p>7717-3DAPG RoHS Compliant Product Change Notice </p>	
<p>(DAP)</p>	
<p>Leads: 4-Mar</p>	
<p>Outside Diameter mm (in): 8.71 (0.343)</p>	
<p>Thickness: 1.91 (0.075)</p>	
<p>7717-3NG RoHS Compliant Product Change Notice </p>	
<p>(nylon)</p>	
<p>Leads: 4-Mar</p>	
<p>Outside Diameter mm (in): 8.71 (0.343)</p>	
<p>Thickness: 1.91 (0.075)</p>	
<p>7717-79DAPG RoHS Compliant Product Change Notice </p>	
<p>(DAP)</p>	
<p>Leads: 3</p>	
<p>Outside Diameter mm (in): 9.02 (0.355)</p>	
<p>Thickness: 0.97 (0.038)</p>	
<p>7717-79NG RoHS Compliant Product Change Notice </p>	
<p>(nylon)</p>	
<p>Leads: 3</p>	
<p>Outside Diameter mm (in): 9.02 (0.355)</p>	
<p>Thickness: 0.97 (0.038)</p>	
<p>7717-178DAPG RoHS Compliant Product Change Notice </p>	
<p>(DAP)</p>	
<p>Leads: 3</p>	
<p>Outside Diameter mm (in): 8.89 (0.350)</p>	
<p>Thickness: 0.53 (0.021)</p>	
<p>7717-178NG RoHS Compliant Product Change Notice </p>	
<p>(nylon)</p>	
<p>Leads: 3</p>	
<p>Outside Diameter mm (in): 8.89 (0.350)</p>	
<p>Thickness: 0.53 (0.021)</p>	

<p>7717-86DAPG</p> <p>RoHS  Compliant</p> <p>Product Change Notice </p>	
<p>(DAP)</p>	
<p>Leads: 3</p>	
<p>Outside Diameter mm (in): 8.71 (0.343)</p>	
<p>Thickness: 1.91 (0.075)</p>	
<p>7717-86NG</p> <p>RoHS  Compliant</p> <p>Product Change Notice </p>	
<p>(nylon)</p>	
<p>Leads: 3</p>	
<p>Outside Diameter mm (in): 8.71 (0.343)</p>	
<p>Thickness: 1.91 (0.075)</p>	
<p>7717-22NG</p> <p>RoHS  Compliant</p>	
<p>(nylon)</p>	
<p>Leads: 3</p>	
<p>Outside Diameter mm (in): 8.71 (0.343)</p>	
<p>Thickness: 1.91 (0.075)</p>	
<p>7717-22DAPG</p> <p>RoHS  Compliant</p>	
<p>(DAP)</p>	
<p>Leads: 3</p>	
<p>Outside Diameter mm (in): 8.71 (0.343)</p>	
<p>Thickness: 1.91 (0.075)</p>	
<p>7717-238NG</p> <p>RoHS  Compliant</p>	
<p>(nylon)</p>	
<p>Leads: 4-Mar</p>	
<p>Outside Diameter mm (in): 10.16 (0.400)</p>	
<p>Thickness: 4.06 (0.160)</p>	
<p>7717-300NG</p> <p>RoHS  Compliant</p>	
<p>(nylon)</p>	
<p>Leads: Universal</p>	

<p>Outside Diameter mm (in): 11.18 (0.440)</p> <p>Thickness: 9.65 (0.380)</p>	
<p>7717-94NG</p> <p>RoHS  Compliant</p>	
<p>(nylon)</p>	
<p>Leads: 4-Mar</p>	
<p>Outside Diameter mm (in): 8.89 (0.350)</p>	
<p>Thickness: 0.97 (0.038)</p>	

Mouser Electronics

Authorized Distributor

Click to View Pricing, Inventory, Delivery & Lifecycle Information:

[Aavid:](#)

[7717-15DAPG](#) [7717-15NG](#) [7717-3DAPG](#) [7717-3NG](#) [7717-4NG](#) [7717-5DAPG](#) [7717-79NG](#) [7717-86DAPG](#) [7717-86NG](#) [7717-5NG](#) [7717-94NG](#) [7717-22NG](#) [7717-22DAPG](#)