

# Detector Switch Low-profile One-way Operation Type

SPVP Series



Long 2mm travel and 1.2mm thickness low-profile structure.

## Detector

Push

Slide

Rotary

Encoders

Power

Dual-in-line  
Package Type

TACT Switch™

Custom-  
Products

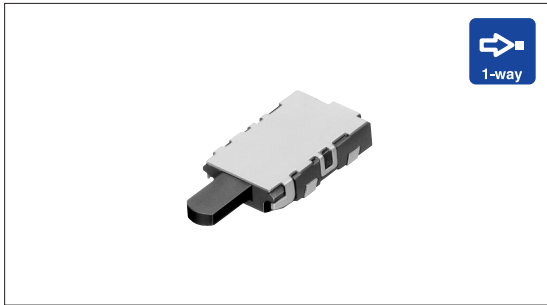

## Typical Specifications

Items		Specifications
Rating (max.) / (min.) (Resistive load)		1mA 5V DC/100μA 3V DC
Contact resistance (Initial /After operating life)		5Ω max./10Ω max.
Operating force		0.55N max.
Operating life	Without load	50,000cycles
	With load	50,000cycles (1mA 5V DC)

## Product Line

Poles	Positions	Terminal type	Location lug	Minimum order unit (pcs.)	Product No.
1	1	For PC board (Reflow)	With	18,000	SPVP110100
			Without		SPVP120100

## Packing Specifications

### Taping

Unit:mm

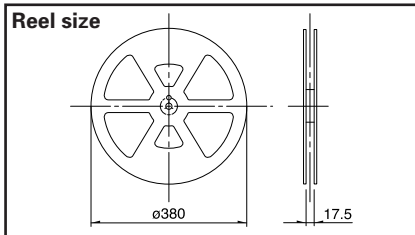

Number of packages (pcs.)			Tape width (mm)	Export package measurements (mm)
1 reel	1 case /Japan	1 case /export packing		
4,500	9,000	18,000	16	417 × 409 × 139

## Dimensions

Unit:mm

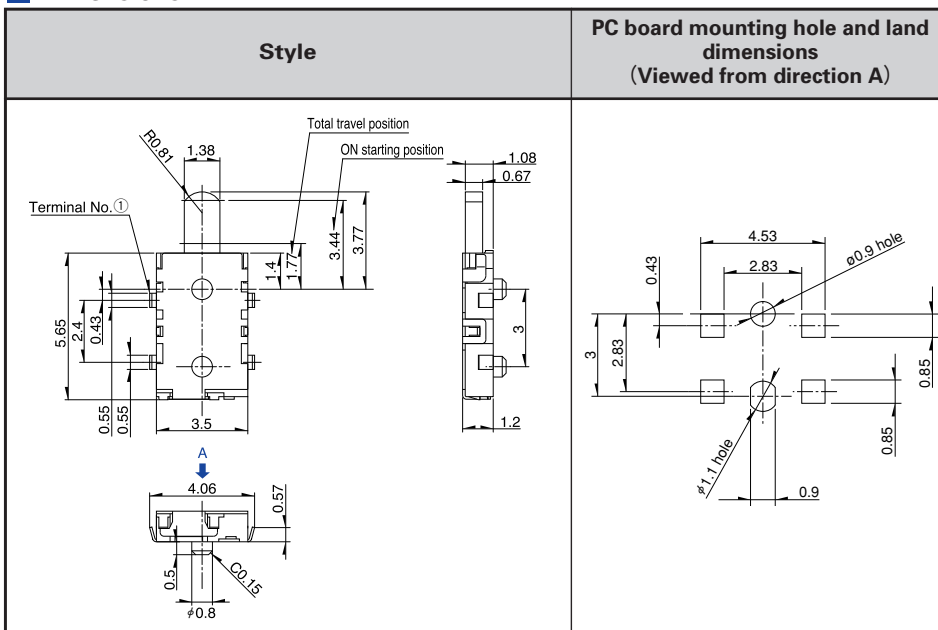

## Terminal Layout

(Viewed from Direction A)

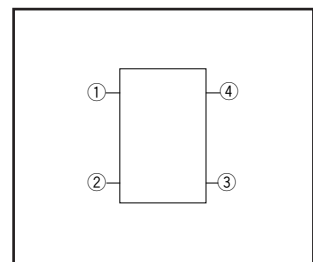

## Circuit Diagram

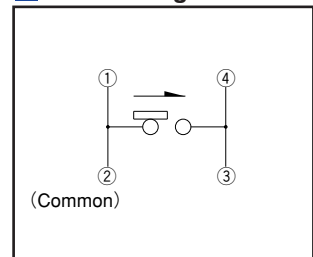

## Notes











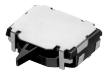

- Above dimensions indicate "with location lug" version.
- Please place purchase orders per minimum order unit N (integer).



Automotive  
Use

Refer to P.97 for soldering conditions.

## List of Varieties (General-purpose Type)

Series	General-purpose Type						
	SSCT	SSCF	SSCM	SPVP	SPVN	SPVS	
Photo							
Operation type							
Operating temperature range	-40°C to +85°C		-10°C to +60°C	-40°C to +85°C			
Automotive use	●	●	—	●	●	●	
Rating(max.) (Resistive load)	0.1A 12V DC			1mA 5V DC			
Rating(min.) (Resistive load)	50μA 3V DC			100μA 3V DC	50μA 3V DC		
Electrical performance	Initial contact resistance	200mΩ max.	100mΩ max.	2Ω max.	5Ω max.	2Ω max.	
	Insulation resistance	100MΩ min. 250V DC	100MΩ min. 100V DC				
	Voltage proof	250V AC for 1 minute	100V AC for 1 minute				
Mechanical performance	Terminal strength	3N for 1 minute	5N for 1 minute	0.5N for 1 minute			
	Actuator strength	20N	10N	2N	5N		
Durability	Operating life without Load	10,000cycles 500mΩ max.	50,000cycles 300mΩ max.	50,000cycles 5Ω max.	50,000cycles 10Ω max.	50,000cycles 5Ω max.	
	Operating life with Load	(0.1A 12V DC) 10,000cycles 500mΩ max.	(0.1A 12V DC) 50,000cycles 300mΩ max.	(1mA 5V DC) 50,000cycles 5Ω max.	(1mA 5V DC) 50,000cycles 10Ω max.	(1mA 5V DC) 50,000cycles 5Ω max.	
Environmental performance	Cold	-40±2°C for 500h		-20±2°C for 96h	-40±2°C for 500h		
	Dry heat	85±2°C for 500h		85±2°C for 96h	85±2°C for 500h		
	Damp heat	60±2°C, 90 to 95%RH for 500h		40±2°C, 90 to 95%RH for 96h	60±2°C, 90 to 95%RH for 500h		
Dimensions (mm)	W	12.5	11	5	3.5	3.8	
	D	5	5.8	4	5.65	3.6	
	H	11.5	12.4	1.5	1.2	1	
Soldering	Manual soldering	350±5°C, 3s max.	350±10°C, 3 <sup>-1</sup> s	350±5°C, 3s max.			
	Dip soldering	260±5°C, 5±1s			—		
	Reflow soldering	—			Please see P.97		
Number of poles	1						
Operation force	0.7±0.3N	0.7N max.	0.35N max.	0.55N max.	0.35N max.		
Page	59	60	62	63	64	66	

Detector

Push

Slide

Rotary

Encoders

Power

Dual-in-line  
Package Type

TACT Switch™

Custom-  
Products

- Detector Switches Soldering Conditions .....97
- Detector Switches Cautions .....98

### Note

●marks in "Available for automotive use" indicate that all of the series products can work at the operating temperature range from -40°C to +85°C.

## Soldering Conditions

### Example of Reflow Soldering Condition

1. Heating method: Double heating method with infrared heater.
2. Temperature measurement: Thermocouple 0.1 to 0.2  $\phi$  CA (K) or CC (T) at soldering portion (copper foil surface). A heat resisting tape should be used for fixed measurement.
3. Temperature profile

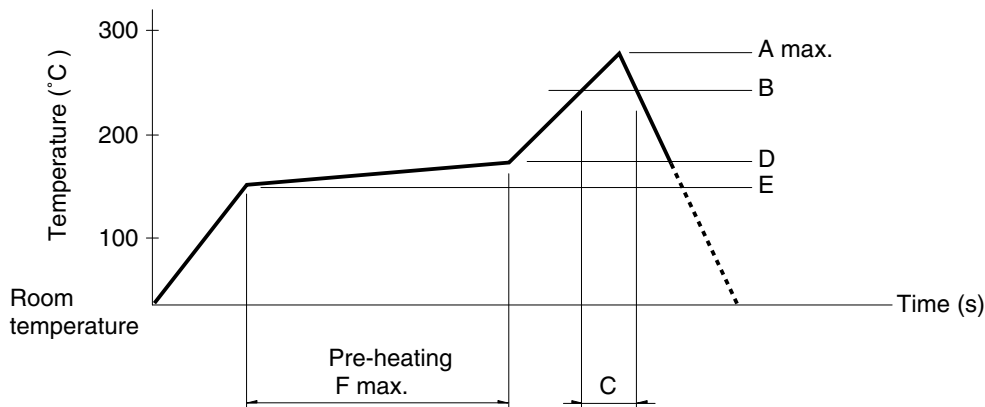

Series (Reflow type)	A (°C) 3s max.	B (°C)	C (s)	D (°C)	E (°C)	F (s)			
SPPB	250	230	40	180	150	120			
SPPW8		200	20						
SPVE	260	230	40						
SPVG									
SPVL									
SPVM									
SPVN									
SPVP									
SPVR									
SPVS									
SPVT									
SSCM									
SPPY5	240		20				150	Room temperature	180

### Notes

1. The condition mentioned above is the temperature on the mounting surface of a PC board. There are cases where the PC board's temperature greatly differs from that of the switch, surface depending on the PC board's material, size, thickness, etc. The above-stated conditions shall also apply to switch surface temperatures.
2. Soldering conditions differ depending on reflow soldering machines. Prior verification of soldering condition is highly recommended.

- Detector
- Push
- Slide
- Rotary
- Encoders
- Power
- Dual-in-line Package Type
- TACT Switch™
- Custom-Products