

Tous droits strictement reserves. Reproduction ou communication a des tiers interdite sous quelque forme que ce soit sans autorisation ecrite du proprietaire. Propriete de c FCI. Droits de reproduction FCI.

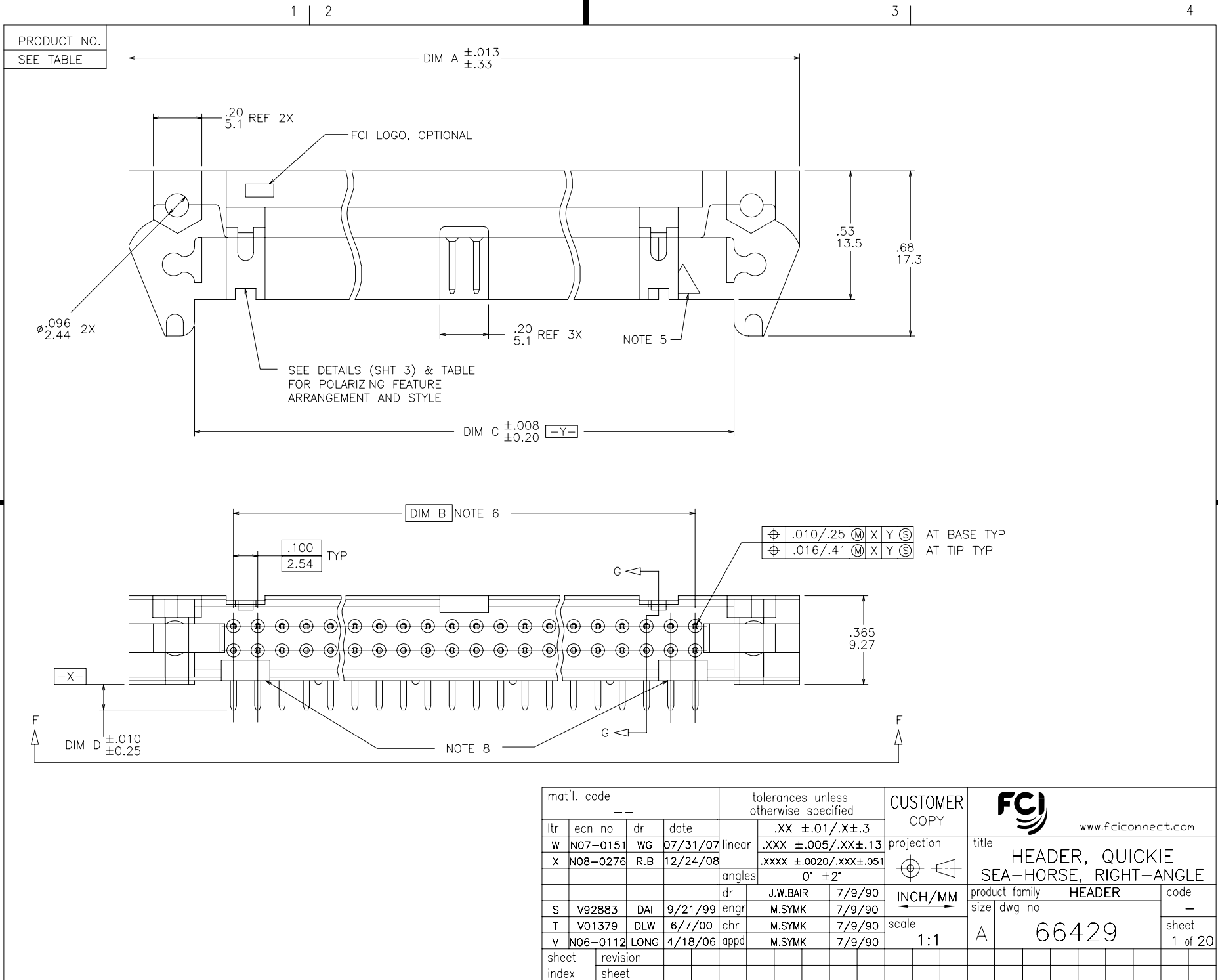

All rights strictly reserved. Reproduction or issue to third parties in any form whatever is not permitted without written authority from the proprietor. Property of FCI. Copyright FCI.



PRODUCT NO.
SEE TABLE

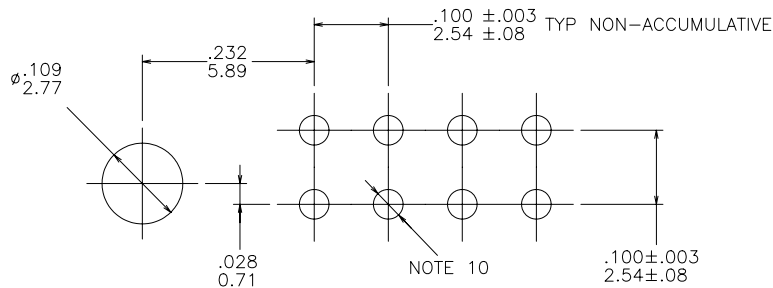

RECOMMENDED HOLE PATTERN
SCALE 10:1

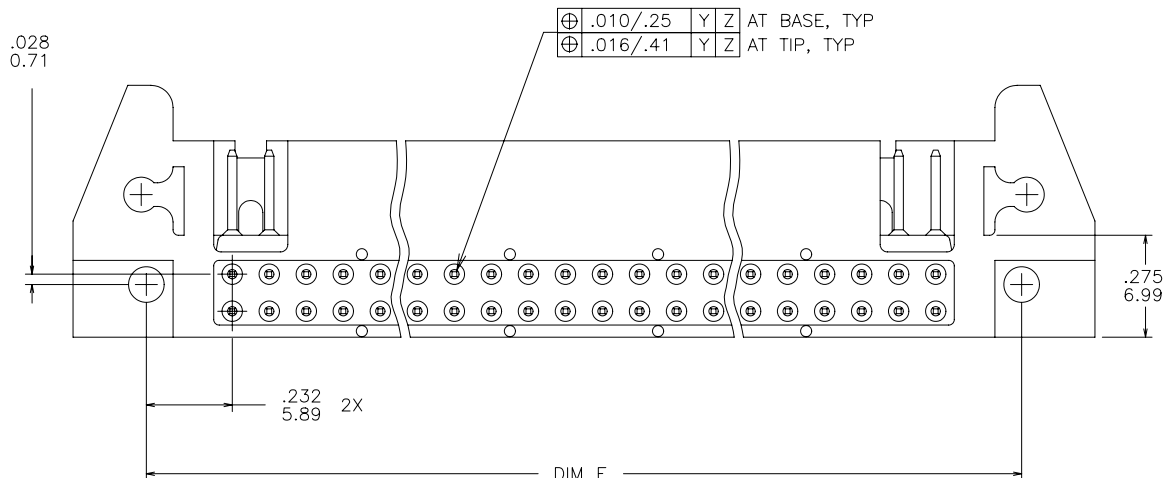

VIEW F-F

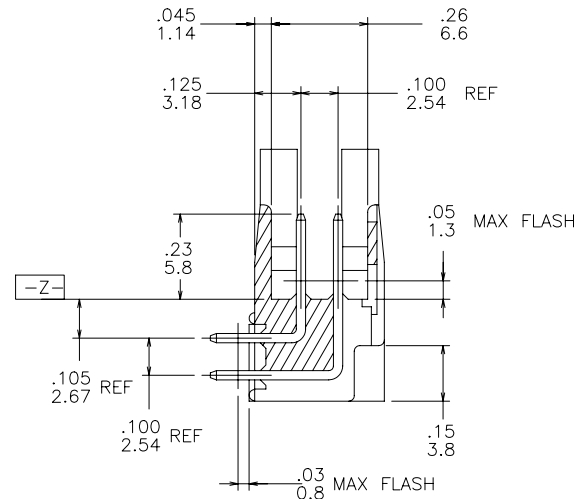

SECTION G-G
ROTATED 90° CW

Tous droits strictement reserves. Reproduction ou communication a des tiers interdite sous quelque forme que ce soit sans autorisation ecrite du proprietaire. Propriete de c FCI. Droits de reproduction FCI.



All rights strictly reserved. Reproduction or issue to third parties in any form whatever is not permitted without written authority from the proprietor. Property of FCI. Copyright FCI.

A

B

A

B

mat'l. code --				tolerances unless otherwise specified		CUSTOMER COPY	www.fciconnect.com
ltr	ecn no	dr	date	linear	.XX ±.01/.X±.3		
X				linear	.XXX ±.005/.XX±.13		product family HEADER
				angles	.XXX ±.0020/.XXX±.051		
				dr	0° ±2'	scale	size
				enr	J.W.BAIR 7/9/90	1:1	dwg no
				chr	M.SYMK 7/9/90		A
				appd	M.SYMK 7/9/90		66429
sheet index	revision sheet						sheet 2 of

PRODUCT NUMBER
SEE TABLE

LP LATCH 66177-001
STD LATCH 65824-001
NOTE 9

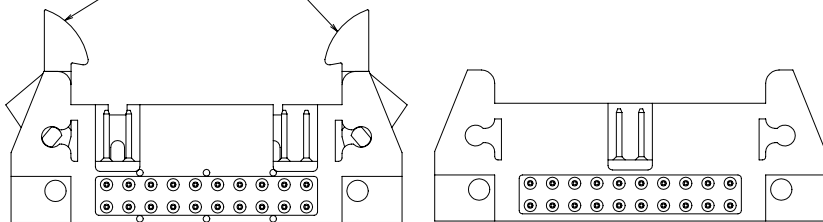

HEADER WITH LATCHES

NOTE 12
2x8 THRU 2x30
(2x10 SHOWN)
STYLE E

BOTTOM VIEW

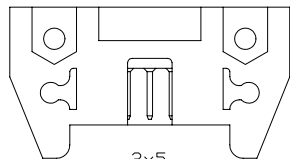

2x5
STYLE A

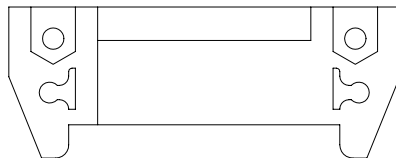

2x8 THRU 2x30
(2x10 SHOWN)
STYLE E

TOP VIEW

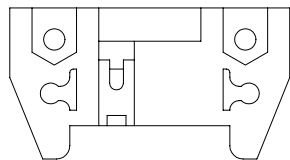

2x5
STYLE B

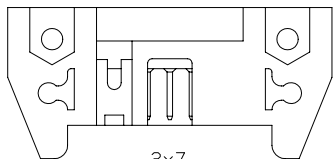

2x7
STYLE C

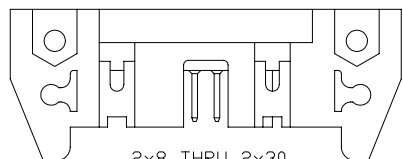

2x8 THRU 2x30
(2x10 SHOWN)
STYLE D

NOTES:

- RECOMMENDED MOUNTING SCREW SIZE: #2-56 FILLISTER HD MACH SCREW, 3/8" LG. FOR 1/16" & 3/32" BOARD/16 LG FOR 1/8" BOARD.
- MOLDING MAT'L: 30% GLASS FILLED POLYESTER, FLAME RETARDANT PER UL-94V-0, COLOR: BLUE.
- PIN MATERIAL: 3/4 HARD PHOS.-BRONZE ALLOY UNS C-51000.
- 1° MAX DRAFT PERMISSIBLE ON ALL SURFACES UNLESS OTHERWISE SPECIFIED.
- PIN #1 IDENTIFIER, OPTIONAL.
- B-** BASIC DIM SHALL BE LOCATED SYMMETRICAL TO DATUM -Y-.
- PLATING ON LEAD-IN PORTION OF PIN IS MANUFACTURING OPTION.
- THESE SLOTS DO NOT EXIST ON 2x5 AND 2x7 SIZES.
- THE LATCHES THAT ARE INSTALLED IN SOME HEADERS MUST WITHSTAND A PUSHOUT FORCE OF 2.0 LBS/.9 KGS MIN WHILE IN THE INSTALLATION POSITION.
- .040±.003/1.02±.08 DIA HOLE TYP FOR SQ PINS, .035±.003/.89±.08 DIA HOLE TYP FOR ROUND PINS.
- RETENTION FEATURE AVAILABLE ON ROUND PIN P/N'S ONLY. RETENTION INCLUDES THE LETTER 'R' AFTER THE EXISTING P/N. FOR TUBE PKG, P/N INCLUDES THE LETTER 'T' AFTER THE EXISTING P/N.
EXAMPLE: 66429-XXX FOR EXISTING P/N
66429-XXXR FOR RETENTION P/N
66429-XXXT FOR TUBE PKG. P/N
66429-XXXRT FOR RETENTION & TUBE PKG. P/N
15 LBS/6.8 KGS MAX INSERTION AND .25 LBS/.1 KGS MIN RETENTION FORCE WHEN USED IN .89±.08/.035±.003 DIA HOLES AND 1.57/.062 THICK PC BOARD. RETENTION FEATURE LOCATION IS MANUFACTURERS OPTION.
- STYLE "E" DOES NOT HAVE ANY POLARIZING SLOTS. THE KEY SLOT IS LOCATED IN THE BOTTOM SIDE.
- PIN #1 REMOVED ON DASH# -609.
- MOLDING MAT'L: 30% GLASS FILLED POLYESTER. FLAME RETARDANT PER UL-94V-0. COLOR: BLACK.
- MOLDING MAT'L: PCT, FLAME RETARDANT PER UL-94V-0. COLOR: BLACK.
- ADD "LF" SUFFIX AT THE END OF PART NUMBER FOR LEAD FREE OPTION.
- IF "LF" P/N THE PRODUCT MEETS EUROPEAN UNION DIRECTIVES AND OTHER COUNTRY REGULATION AS DESCRIBED IN GS-22-008.
- THE HOUSING WILL WITHSTAND EXPOSURE TO 260° PEAK TEMPERATURE FOR 15 SECONDS IN A WAVE SOLDER APPLICATION WITH A 1.5mm MINIMUM THICK CIRCUIT BOARD. SEE APPLICATION NOTES/PROCEDURES IF THEY ARE AVAILABLE.
- PLATING OPTION: MAYBE EITHER GOLD OT GXT PLATING AT MANUFACTURER'S OPTION .

Tous droits strictement reserves. Reproduction ou communication a des tiers interdite sous quelque forme que ce soit sans autorisation ecrite du proprietaire. Propriete de c FCI. Droits de reproduction FCI.



All rights strictly reserved. Reproduction or issue to third parties in any form whatever is not permitted without written authority from the proprietor. Property of FCI. Copyright FCI.

mat'l. code		tolerances unless otherwise specified		CUSTOMER COPY		FCI www.fciconnect.com	
ltr	ecn no	dr	date	linear	projection	title	
X				.XX ±.01/.X±.3		HEADER, QUICKIE	
				.XXX ±.005/.XX±.13		SEA-HORSE, RIGHT-ANGLE	
				.XXX ±.0020/.XXX±.051	INCH/MM	product family	code
				angles	5/1 1:1	HEADER	-
				dr	J.W.BAIR 7/9/90	size	dwg no
				enr	M.SYMK 7/9/90	66429	
				chr	M.SYMK 7/9/90	sheet	3 of
				appd	M.SYMK 7/9/90		
sheet index	revision sheet						

All rights strictly reserved. Reproduction or issue to third parties in any form whatever is not permitted without written authority from the proprietor.
Property of ©BERG ELECTRONICS Copyright BERG ELECTRONICS INC.



Tous droits strictement réservés. Reproduction ou communication à des tiers interdite sous quelque forme que ce soit sans autorisation écrite du propriétaire.
Propriété de ©BERG ELECTRONICS. Droits de reproduction BERG ELECTRONICS INC.

PRODUCT NO.	SIZE	LATCHES NOTE 9	PIN SHAPE	DIM A	DIM B	DIM C	DIM D	DIM E	TERMINAL PLATING NOTE 19	HSG MATERIAL
66429-001	2x5	NO	ROUND	1.260/32.00	.400/10.16	.720/18.29	.105/2.67	.86/21.8	30µ"/0.76µm Au OVER 50µ"/1.27µm Ni	PBT BLUE
-002			SQ				.105/2.67		150µ"/3.81µm Sn	
-003			ROUND				.150/3.81		30µ"/0.76µm Au OVER 50µ"/1.27µm Ni	
-004			SQ				.150/3.81		150µ"/3.81µm Sn	
-005			SQ				.675/17.15		30µ"/0.76µm Au OVER 50µ"/1.27µm Ni	
-006	2x5		SQ	1.260/32.00	.400/10.16	.720/18.29	.675/17.15	.86/21.8	150µ"/3.81µm Sn	
-007	2x7		ROUND	1.460/37.08	.600/15.24	.920/23.37	.105/2.67	1.06/26.9	30µ"/0.76µm Au OVER 50µ"/1.27µm Ni	
-008			SQ				.105/2.67		150µ"/3.81µm Sn	
-009			ROUND				.150/3.81		30µ"/0.76µm Au OVER 50µ"/1.27µm Ni	
-010			SQ				.150/3.81		150µ"/3.81µm Sn	
-011			SQ				.675/17.15		30µ"/0.76µm Au OVER 50µ"/1.27µm Ni	
-012	2x7		SQ	1.460/37.08	.600/15.24	.920/23.37	.675/17.15	1.06/26.9	150µ"/3.81µm Sn	
-013	2x8		ROUND	1.560/39.62	.700/17.78	1.020/25.91	.105/2.67	1.16/29.5	30µ"/0.76µm Au OVER 50µ"/1.27µm Ni	
-014			SQ				.105/2.67		150µ"/3.81µm Sn	
-015			ROUND				.150/3.81		30µ"/0.76µm Au OVER 50µ"/1.27µm Ni	
-016			SQ				.150/3.81		150µ"/3.81µm Sn	
-017			SQ				.675/17.15		30µ"/0.76µm Au OVER 50µ"/1.27µm Ni	
-018	2x8		SQ	1.560/39.62	.700/17.78	1.020/25.91	.675/17.15	1.16/29.5	150µ"/3.81µm Sn	
-019	2x10		ROUND	1.760/44.70	.900/22.86	1.220/30.99	.105/2.67	1.36/34.5	30µ"/0.76µm Au OVER 50µ"/1.27µm Ni	
-020			SQ				.105/2.67		150µ"/3.81µm Sn	
-021			ROUND				.150/3.81		30µ"/0.76µm Au OVER 50µ"/1.27µm Ni	
-022			SQ				.150/3.81		150µ"/3.81µm Sn	
-023			SQ				.675/17.15		30µ"/0.76µm Au OVER 50µ"/1.27µm Ni	
-024	2x10		SQ	1.760/44.70	.900/22.86	1.220/30.99	.675/17.15	1.36/34.5	150µ"/3.81µm Sn	
-025	2x13		ROUND	2.060/52.32	1.200/30.48	1.520/38.61	.105/2.67	1.66/42.2	30µ"/0.76µm Au OVER 50µ"/1.27µm Ni	
-026			SQ				.105/2.67		150µ"/3.81µm Sn	
-027			ROUND				.150/3.81		30µ"/0.76µm Au OVER 50µ"/1.27µm Ni	
-028			SQ				.150/3.81		150µ"/3.81µm Sn	
-029			SQ				.675/17.15		30µ"/0.76µm Au OVER 50µ"/1.27µm Ni	
-030	2x13		SQ	2.060/52.32	1.200/30.48	1.520/38.61	.675/17.15	1.66/42.2	150µ"/3.81µm Sn	
-031	2x17		ROUND	2.460/62.48	1.600/40.64	1.920/48.77	.105/2.67	2.06/52.3	30µ"/0.76µm Au OVER 50µ"/1.27µm Ni	
-032			SQ				.105/2.67		150µ"/3.81µm Sn	
-033			ROUND				.150/3.81		30µ"/0.76µm Au OVER 50µ"/1.27µm Ni	
-034			SQ				.150/3.81		150µ"/3.81µm Sn	
-035			SQ				.675/17.15		30µ"/0.76µm Au OVER 50µ"/1.27µm Ni	
66429-036	2x17	NO	SQ	2.460/62.48	1.600/40.64	1.920/48.77	.675/17.15	2.06/52.3	150µ"/3.81µm Sn	PBT BLUE

mat'l. code				tolerances unless otherwise specified				CUSTOMER COPY		FCI www.fciconnect.com	
ltr	ecn no	dr	date	linear	.XX ±.01			projection		title	
X					.XXX ±.005					HEADER, QUICKIE	
					.XXXX ±.0020					SEA-HORSE, RIGHT ANGLE	
				angles	0° ±2°			INCH/MM		product family	
				dr	J.W.BAIR	7/9/90	HEADERS			code	
				enr	M.SMYK	7/9/90	size			dwg no	
				chr	M.SMYK	7/9/90	66429			sheet	
				appd	M.SMYK	7/9/90	4 of				
sheet index	revision sheet						scale	1:1	A		

PRODUCT NO.	SIZE	LATCHES NOTE 9	PIN SHAPE	DIM A	DIM B	DIM C	DIM D	DIM E	TERMINAL PLATING NOTE 19	HSG MATERIAL
66429-037	2x20	NO	RND	2.760/70.10	1.900/48.26	2.220/56.39	.105/2.67	2.36/59.94	30μ"/0.76μm Au OVER 50μ"/1.27μm Ni	PBT BLUE
↑ -038	↑	↑	SQ	↑	↑	↑	.105/2.67	↑	150μ"/3.81μm Sn	↑
-039	↑	↑	RND	↑	↑	↑	.150/3.81	↑	30μ"/0.76μm Au OVER 50μ"/1.27μm Ni	↑
-040	↑	↑	SQ	↑	↑	↑	.150/3.81	↑	150μ"/3.81μm Sn	↑
-041	↓	↑	SQ	↓	↓	↓	.675/17.15	↓	30μ"/0.76μm Au OVER 50μ"/1.27μm Ni	↑
-042	2x20	↑	SQ	2.760/70.10	1.900/48.26	2.220/56.39	.675/17.15	2.36/59.94	150μ"/3.81μm Sn	↑
-043	2x25	↑	RND	3.260/82.80	2.400/60.96	2.720/69.09	.105/2.67	2.86/72.64	30μ"/0.76μm Au OVER 50μ"/1.27μm Ni	↑
-044	↑	↑	SQ	↑	↑	↑	.105/2.67	↑	150μ"/3.81μm Sn	↑
-045	↑	↑	RND	↑	↑	↑	.150/3.81	↑	30μ"/0.76μm Au OVER 50μ"/1.27μm Ni	↑
-046	↓	↑	SQ	↓	↓	↓	.150/3.81	↓	150μ"/3.81μm Sn	↑
-047	↓	↑	SQ	↓	↓	↓	.675/17.15	↓	30μ"/0.76μm Au OVER 50μ"/1.27μm Ni	↑
-048	2x25	NO	SQ	3.260/82.80	2.400/60.96	2.720/69.09	.675/17.15	2.86/72.64	150μ"/3.81μm Sn	↑
-049	2x5	STD	RND	1.260/32.00	.400/10.16	.720/18.29	.105/2.67	.86/21.84	30μ"/0.76μm Au OVER 50μ"/1.27μm Ni	↑
-050	↑	↑	SQ	↑	↑	↑	.105/2.67	↑	150μ"/3.81μm Sn	↑
-051	↑	↑	RND	↑	↑	↑	.150/3.81	↑	30μ"/0.76μm Au OVER 50μ"/1.27μm Ni	↑
-052	↑	↑	SQ	↑	↑	↑	.150/3.81	↑	150μ"/3.81μm Sn	↑
-053	↓	↑	SQ	↓	↓	↓	.675/17.15	↓	30μ"/0.76μm Au OVER 50μ"/1.27μm Ni	↑
-054	2x5	↑	SQ	1.260/32.00	.400/10.16	.720/18.29	.675/17.15	.86/21.84	150μ"/3.81μm Sn	↑
-055	2x7	↑	RND	1.460/37.08	.600/15.24	.920/23.37	.105/2.67	1.06/26.92	30μ"/0.76μm Au OVER 50μ"/1.27μm Ni	↑
-056	↑	↑	SQ	↑	↑	↑	.105/2.67	↑	150μ"/3.81μm Sn	↑
-057	↑	↑	RND	↑	↑	↑	.150/3.81	↑	30μ"/0.76μm Au OVER 50μ"/1.27μm Ni	↑
-058	↑	↑	SQ	↑	↑	↑	.150/3.81	↑	150μ"/3.81μm Sn	↑
-059	↓	↑	SQ	↓	↓	↓	.675/17.15	↓	30μ"/0.76μm Au OVER 50μ"/1.27μm Ni	↑
-060	2x7	↑	SQ	1.460/37.08	.600/15.24	.920/23.37	.675/17.15	1.06/26.92	150μ"/3.81μm Sn	↑
-061	2x8	↑	RND	1.560/39.62	.700/17.78	1.020/25.91	.105/2.67	1.16/29.46	30μ"/0.76μm Au OVER 50μ"/1.27μm Ni	↑
-062	↑	↑	SQ	↑	↑	↑	.105/2.67	↑	150μ"/3.81μm Sn	↑
-063	↑	↑	RND	↑	↑	↑	.150/3.81	↑	30μ"/0.76μm Au OVER 50μ"/1.27μm Ni	↑
-064	↑	↑	SQ	↑	↑	↑	.150/3.81	↑	150μ"/3.81μm Sn	↑
-065	↓	↑	SQ	↓	↓	↓	.675/17.15	↓	30μ"/0.76μm Au OVER 50μ"/1.27μm Ni	↑
-066	2x8	↑	SQ	1.560/39.62	.700/17.78	1.020/25.91	.675/17.15	1.16/29.46	150μ"/3.81μm Sn	↑
-067	2x10	↑	RND	1.760/44.70	.900/22.86	1.220/30.99	.105/2.67	1.36/34.54	30μ"/0.76μm Au OVER 50μ"/1.27μm Ni	↑
-068	↑	↑	SQ	↑	↑	↑	.105/2.67	↑	150μ"/3.81μm Sn	↑
-069	↑	↑	RND	↑	↑	↑	.150/3.81	↑	30μ"/0.76μm Au OVER 50μ"/1.27μm Ni	↑
-070	↑	↑	SQ	↑	↑	↑	.150/3.81	↑	150μ"/3.81μm Sn	↑
-071	↓	↑	SQ	↓	↓	↓	.675/17.15	↓	30μ"/0.76μm Au OVER 50μ"/1.27μm Ni	↑
66429-072	2x10	STD	SQ	1.760/44.70	.900/22.86	1.220/30.99	.675/17.15	1.36/34.54	150μ"/3.81μm Sn	PBT BLUE

Tous droits strictement reserves. Reproduction ou communication a des tiers interdite sous quelque forme que ce soit sans autorisation ecrite du proprietaire. Propriete de c FCI. Droits de reproduction FCI.



All rights strictly reserved. Reproduction or issue to third parties in any form whatever is not permitted without written authority from the proprietor. Property of FCI. Copyright FCI.

mat'l. code --				tolerances unless otherwise specified		CUSTOMER COPY	www.fciconnect.com
ltr	ecn no	dr	date	linear	.XX ±.01/.X±.3 .XXX ±.005/.XX±.13 .xxx ±.0020/.xxx±.051		
X				angles	0' ±2'		HEADER, QUICKIE SEA-HORSE, RIGHT-ANGLE
				dr	J.W.BAIR 7/9/90	INCH/MM	product family
				enr	M.SYMK 7/9/90		HEADER
				chr	M.SYMK 7/9/90	scale	size dwg no
				appd	M.SYMK 7/9/90	1:1	66429
sheet index	revision sheet						code
							5 of

Tous droits strictement reserves. Reproduction ou communication a des tiers interdite sous quelque forme que ce soit sans autorisation ecrite du proprietaire. Propriete de c FCI. Droits de reproduction FCI.



All rights strictly reserved. Reproduction or issue to third parties in any form whatever is not permitted without written authority from the proprietor. Property of FCI. Copyright FCI.

PRODUCT NO.	SIZE	LATCHES NOTE 9	PIN SHAPE	DIM A	DIM B	DIM C	DIM D	DIM E	TERMINAL PLATING NOTE 19	HSG MATERIAL
66429-073	2x13	STD	RND	2.060/52,32	1.200/30,480	1.520/38,61	.105/ 2,67	1.66/42,16	30µ"/0.76µm Au OVER 50µ"/1.27µm Ni	PBT BLUE
-074			SQ				.105/ 2,67		150µ"/3.81µm Sn	
-075			RND				.150/ 3,81		30µ"/0.76µm Au OVER 50µ"/1.27µm Ni	
-076			SQ				.150/ 3,81		150µ"/3.81µm Sn	
-077			SQ				.675/17,15		30µ"/0.76µm Au OVER 50µ"/1.27µm Ni	
-078	2x13		SQ	2.060/52,32	1.200/30,480	1.520/38,61	.675/17,15	1.66/42,16	150µ"/3.81µm Sn	
-079	2x17		RND	2.460/62,48	1.600/40,640	1.920/48,77	.105/ 2,67	2.06/52,32	30µ"/0.76µm Au OVER 50µ"/1.27µm Ni	
-080			SQ				.105/ 2,67		150µ"/3.81µm Sn	
-081			RND				.150/ 3,81		30µ"/0.76µm Au OVER 50µ"/1.27µm Ni	
-082			SQ				.150/ 3,81		150µ"/3.81µm Sn	
-083			SQ				.675/17,15		30µ"/0.76µm Au OVER 50µ"/1.27µm Ni	
-084	2x17		SQ	2.460/62,48	1.600/40,640	1.920/48,77	.675/17,15	2.06/52,32	150µ"/3.81µm Sn	
-085	2x20		RND	2.760/ 70,1	1.900/48,260	2.220/56,39	.105/ 2,67	2.36/59,94	30µ"/0.76µm Au OVER 50µ"/1.27µm Ni	
-086			SQ				.105/ 2,67		150µ"/3.81µm Sn	
-087			RND				.150/ 3,81		30µ"/0.76µm Au OVER 50µ"/1.27µm Ni	
-088			SQ				.150/ 3,81		150µ"/3.81µm Sn	
-089			SQ				.675/17,15		30µ"/0.76µm Au OVER 50µ"/1.27µm Ni	
-090	2x20		SQ	2.760/ 70,1	1.900/48,260	2.220/56,39	.675/17,15	2.36/59,94	150µ"/3.81µm Sn	
-091	2x25		RND	3.260/ 82,8	2.400/60,960	2.720/69,09	.105/ 2,67	2.86/72,64	30µ"/0.76µm Au OVER 50µ"/1.27µm Ni	
-092			SQ				.105/ 2,67		150µ"/3.81µm Sn	
-093			RND				.150/ 3,81		30µ"/0.76µm Au OVER 50µ"/1.27µm Ni	
-094			SQ				.150/ 3,81		150µ"/3.81µm Sn	
-095			SQ				.675/17,15		30µ"/0.76µm Au OVER 50µ"/1.27µm Ni	
-096	2x25	STD	SQ	3.260/ 82,8	2.400/60,960	2.720/69,09	.675/17,15	2.86/72,64	150µ"/3.81µm Sn	
-097	2x30	NO	RND	3.760/ 95,5	2.900/73,660	3.220/81,79	.105/ 2,67	3.36/85,34	30µ"/0.76µm Au OVER 50µ"/1.27µm Ni	
-098			SQ				.105/ 2,67		150µ"/3.81µm Sn	
-099			RND				.150/ 3,81		30µ"/0.76µm Au OVER 50µ"/1.27µm Ni	
-100			SQ				.150/ 3,81		150µ"/3.81µm Sn	
-101			SQ				.675/17,15		30µ"/0.76µm Au OVER 50µ"/1.27µm Ni	
-102		NO	SQ				.675/17,15		150µ"/3.81µm Sn	
-103		STD	RND				.105/ 2,67		30µ"/0.76µm Au OVER 50µ"/1.27µm Ni	
-104			SQ				.105/ 2,67		150µ"/3.81µm Sn	
-105			RND				.150/ 3,81		30µ"/0.76µm Au OVER 50µ"/1.27µm Ni	
-106			SQ				.150/ 3,81		150µ"/3.81µm Sn	
-107			SQ				.675/17,15		30µ"/0.76µm Au OVER 50µ"/1.27µm Ni	
66429-108	2x30	STD	SQ	3.760/ 95,5	2.900/73,660	3.220/81,79	.675/17,15	3.36/85,34	150µ"/3.81µm Sn	PBT BLUE

mat'l. code		--		tolerances unless otherwise specified		CUSTOMER COPY		FCI www.fciconnect.com	
ltr	ecn no	dr	date	linear	.XX ±.01/.X±.3	projection		title	
X					.XXX ±.005/.XX±.13			HEADER, QUICKIE	
				angles	.xxx ±.0020/.xxx±.051			SEA-HORSE, RIGHT-ANGLE	
					0' ±2'			product family	code
				dr	J.W.BAIR 7/9/90	INCH/MM		HEADER	-
				enr	M.SYMK 7/9/90			size	dwg no
				chr	M.SYMK 7/9/90	scale		66429	sheet
				appd	M.SYMK 7/9/90	1:1	A	6 of	
sheet index	revision sheet								

PRODUCT NO.	SIZE	LATCHES NOTE 9	PIN SHAPE	DIM A	DIM B	DIM C	DIM D	DIM E	TERMINAL PLATING NOTE 19	STYLE	HSG. MATERIAL
66429-109	2x5	ND	SQ	1.260/32.00	.400/10.16	.720/18.29	.105/ 2.67	.86/21.84	30µ"/0.76µm Au OVER 50µ"/1.27µm Ni		PBT BLUE
-110	2x7	↑	↑	1.460/37.08	.600/15.24	.920/23.37	↑	1.06/26.92		C	↑
-111	2x8	↑	↑	1.560/39.62	.700/17.78	1.020/25.91	↑	1.16/29.46		D	↑
-112	2x10	↑	↑	1.760/ 44.70	.900/22.86	1.220/30.99	↑	1.36/34.54		↑	↑
-113	2x13	↑	↑	2.060/52.32	1.200/30.48	1.520/38.61	↑	1.66/42.16		↑	↑
-114	2x17	↑	↑	2.460/62.48	1.600/40.64	1.920/48.77	↑	2.06/52.32		↑	↑
-115	2x20	↑	↑	2.760/70.10	1.900/48.26	2.220/56.39	↑	2.36/59.94		↑	↑
-116	2x25	↓	↓	3.260/82.80	2.400/60.96	2.720/69.09	↓	2.86/72.64		↓	↓
-117	2x30	ND		3.760/95.50	2.900/73.66	3.220/81.79		3.36/85.34		D	
-118	2x5	STD		1.260/32.00	.400/10.16	.720/18.29		.86/21.84		A	
-119	2x7	↑	↑	1.460/37.08	.600/15.24	.920/23.37	↑	1.06/26.92		C	↑
-120	2x8	↑	↑	1.560/39.62	.700/17.78	1.020/25.91	↑	1.16/29.46		D	↑
-121	2x10	↑	↑	1.760/44.70	.900/22.86	1.220/30.99	↑	1.36/34.54		↑	↑
-122	2x13	↑	↑	2.060/52.32	1.200/30.48	1.520/38.61	↑	1.66/42.16		↑	↑
-123	2x17	↑	↑	2.460/62.48	1.600/40.64	1.920/48.77	↑	2.06/52.32		↑	↑
-124	2x20	↑	↑	2.760/ 70.1	1.900/48.26	2.220/56.39	↑	2.36/59.94		↑	↑
-125	2x25	↓	↓	3.260/ 82.80	2.400/60.96	2.720/69.09	↓	2.86/72.64		↓	↓
-126	2x30	STD	SQ	3.760/ 95.50	2.900/73.66	3.220/81.79	.105/2.67	3.36/85.34	30µ"/0.76µm Au OVER 50µ"/1.27µm Ni	D	
-127	2x5	ND	RND	1.260/32.00	.400/10.16	.720/18.29	.150/3.81	.86/21.84	30µ"/0.76µm GXT WITH Au FLASH	A	
-128	2x7	↑	↑	1.460/37.08	.600/15.24	.920/23.37	↑	1.06/26.92		C	↑
-129	2x8	↑	↑	1.560/39.62	.700/17.78	1.020/25.91	↑	1.16/29.46		D	↑
-130	2x10	↑	↑	1.760/44.70	.900/22.86	1.220/30.99	↑	1.36/34.54		↑	↑
-131	2x13	↑	↑	2.060/52.32	1.200/30.48	1.520/38.61	↑	1.66/42.16		↑	↑
-132	2x17	↑	↑	2.460/62.48	1.600/40.64	1.920/48.77	↑	2.06/52.32		↑	↑
-133	2x20	↑	↑	2.760/70.10	1.900/48.26	2.220/56.39	↑	2.36/59.94		↑	↑
-134	2x25	↓	↓	3.260/82.80	2.400/60.96	2.720/69.09	↓	2.86/72.64		↓	↓
-135	2x30	ND		3.760/95.50	2.900/73.66	3.220/81.79		3.36/85.34		D	
-136	2x5	STD		1.260/32.00	.400/10.16	.720/18.29		.86/21.84		A	
-137	2x7	↑	↑	1.460/37.08	.600/15.24	.920/23.37	↑	1.06/26.92		C	↑
-138	2x8	↑	↑	1.560/39.62	.700/17.78	1.020/25.91	↑	1.16/29.46		D	↑
-139	2x10	↑	↑	1.760/ 44.70	.900/22.86	1.220/30.99	↑	1.36/34.54		↑	↑
-140	2x13	↑	↑	2.060/52.32	1.200/30.48	1.520/38.61	↑	1.66/42.16		↑	↑
-141	2x17	↑	↑	2.460/62.48	1.600/40.64	1.920/48.77	↑	2.06/52.32		↑	↑
-142	2x20	↑	↑	2.760/70.10	1.900/48.26	2.220/56.39	↑	2.36/59.94		↑	↑
-143	2x25	↓	↓	3.260/82.80	2.400/60.96	2.720/69.09	↓	2.86/72.64		↓	↓
66429-144	2x30	STD	RND	3.760/95.50	2.900/73.66	3.220/81.79	.150/ 3.81	3.36/85.34	30µ"/0.76µm GXT WITH Au FLASH	D	PBT BLUE

Tous droits strictement reserves. Reproduction ou communication a des tiers interdite sous quelque forme que ce soit sans autorisation ecrite du proprietaire. Propriete de c FCI. Droits de reproduction FCI.



All rights strictly reserved. Reproduction or issue to third parties in any form whatever is not permitted without written authority from the proprietor. Property of FCI. Copyright FCI.

mat'l. code		tolerances unless otherwise specified		CUSTOMER COPY		 www.fciconnect.com	
ltr	ecn no	dr	date	linear	.XX ±.01/.X±.3	projection	title
X					.XXX ±.005/.XX±.13		HEADER, QUICKIE
				angles	.XXX ±.0020/.XXX±.051	INCH/MM	SEA-HORSE, RIGHT-ANGLE
				dr	0' ±2'	scale	product family
				enr	J.W.BAIR 7/9/90	1:1	HEADER
				chr	M.SYMK 7/9/90	A	size
				appd	M.SYMK 7/9/90	66429	dwg no
sheet index	revision sheet						code
							-
							sheet
							7 of

PRODUCT NO.	SIZE	LATCHES NOTE 9	PIN SHAPE	DIM A	DIM B	DIM C	DIM D	DIM E	TERMINAL PLATING NOTE 19	STYLE	HSG. MATERIAL
66429-145	2x5	LP	RND	1.260/32.00	.400/10.16	.720/18.29	.105/ 2.67	.86/21,84	30µ"/0.76µm Au OVER 50µ"/1.27µm Ni	A	PBT BLUE
-146			SQ				.105/ 2.67		150µ"/3.81µm Sn		
-147			RND				.150/3.81		30µ"/0.76µm Au OVER 50µ"/1.27µm Ni		
-148			SQ				.150/3.81		150µ"/3.81µm Sn		
-149			SQ				.675/17.15		30µ"/0.76µm Au OVER 50µ"/1.27µm Ni		
-150	2x5		SQ	1.260/32.00	.400/10.16	.720/18.29	.675/17.15	.86/21,84	150µ"/3.81µm Sn	A	
-151	2x7		RND	1.460/37.08	.600/15.24	.920/23.37	.105/2.67	1.06/26,92	30µ"/0.76µm Au OVER 50µ"/1.27µm Ni	C	
-152			SQ				.105/2.67		150µ"/3.81µm Sn		
-153			RND				.150/3.81		30µ"/0.76µm Au OVER 50µ"/1.27µm Ni		
-154			SQ				.150/3.81		150µ"/3.81µm Sn		
-155			SQ				.675/17.15		30µ"/0.76µm Au OVER 50µ"/1.27µm Ni		
-156	2x7		SQ	1.460/37.08	.600/15.24	.920/23.37	.675/17.15	1.06/26,92	150µ"/3.81µm Sn	C	
-157	2x8		RND	1.560/39.62	.700/17.78	1.020/25.91	.105/2.67	1.16/29,46	30µ"/0.76µm Au OVER 50µ"/1.27µm Ni	D	
-158			SQ				.105/2.67		150µ"/3.81µm Sn		
-159			RND				.150/3.81		30µ"/0.76µm Au OVER 50µ"/1.27µm Ni		
-160			SQ				.150/3.81		150µ"/3.81µm Sn		
-161			SQ				.675/17.15		30µ"/0.76µm Au OVER 50µ"/1.27µm Ni		
-162	2x8		SQ	1.560/39.62	.700/17.78	1.020/25.91	.675/17.15	1.16/29,46	150µ"/3.81µm Sn		
-163	2x10		RND	1.760/44.70	.900/22.86	1.220/30.99	.105/2.67	1.36/34,54	30µ"/0.76µm Au OVER 50µ"/1.27µm Ni		
-164			SQ				.105/2.67		150µ"/3.81µm Sn		
-165			RND				.150/3.81		30µ"/0.76µm Au OVER 50µ"/1.27µm Ni		
-166			SQ				.150/3.81		150µ"/3.81µm Sn		
-167			SQ				.675/17.15		30µ"/0.76µm Au OVER 50µ"/1.27µm Ni		
-168	2x10		SQ	1.760/ 44.70	.900/22,860	1.220/30.99	.675/17.15	1.36/34,54	150µ"/3.81µm Sn		
-169	2x13		RND	2.060/52.32	1.200/30.48	1.520/38.61	.105/2.67	1.66/42,16	30µ"/0.76µm Au OVER 50µ"/1.27µm Ni		
-170			SQ				.105/2.67		150µ"/3.81µm Sn		
-171			RND				.150/3.81		30µ"/0.76µm Au OVER 50µ"/1.27µm Ni		
-172			SQ				.150/3.81		150µ"/3.81µm Sn		
-173			SQ				.675/17.15		30µ"/0.76µm Au OVER 50µ"/1.27µm Ni		
-174	2x13		SQ	2.060/52.32	1.200/30.48	1.520/38.61	.675/17.15	1.66/42.16	150µ"/3.81µm Sn		
-175	2x17		RND	2.460/62.48	1.600/40.64	1.920/48.77	.105/2.67	2.06/52.32	30µ"/0.76µm Au OVER 50µ"/1.27µm Ni		
-176			SQ				.105/2.67		150µ"/3.81µm Sn		
-177			RND				.150/3.81		30µ"/0.76µm Au OVER 50µ"/1.27µm Ni		
-178			SQ				.150/3.81		150µ"/3.81µm Sn		
-179			SQ				.675/17.15		30µ"/0.76µm Au OVER 50µ"/1.27µm Ni		
66429-180	2x17	LP	SQ	2.460/62.48	1.600/40.64	1.920/48.77	.675/17.15	2.06/52.32	150µ"/3.81µm Sn	D	PBT BLUE

Tous droits strictement reserves. Reproduction ou communication a des tiers interdite sous quelque forme que ce soit sans autorisation ecrite du proprietaire. Propriete de c FCI. Droits de reproduction FCI.



All rights strictly reserved. Reproduction or issue to third parties in any form whatever is not permitted without written authority from the proprietor. Property of FCI. Copyright FCI.

mat'l. code		--		tolerances unless otherwise specified		CUSTOMER COPY		www.fciconnect.com	
ltr	ecn no	dr	date	linear	.XX ±.01/.X±.3		projection	title	
X					.XXX ±.005/.XX±.13				
				angles	.XXX ±.0020/.XXX±.051		INCH/MM	product family	
					0' ±2'			HEADER	
				dr	J.W.BAIR	7/9/90	scale	size	
				enr	M.SYMK	7/9/90		dwg no	
				chr	M.SYMK	7/9/90		66429	
				appd	M.SYMK	7/9/90		sheet	
sheet index	revision sheet						1:1	A	8 of

PRODUCT NO.	SIZE	LATCHES NOTE 9	PIN SHAPE	DIM A	DIM B	DIM C	DIM D	DIM E	TERMINAL PLATING NOTE 19	STYLE	HSG. MATERIAL
66429-181	2x20	LP	RND	2.760/70.10	1.900/48.26	2.220/56.39	.105/ 2.67	2.36/59.94	30µ"/0.76µm Au OVER 50µ"/1.27µm Ni	D	PBT BLUE
-182			SQ				.105/ 2.67		150µ"/3.81µm Sn		
-183			RND				.150/ 3.81		30µ"/0.76µm Au OVER 50µ"/1.27µm Ni		
-184			SQ				.150/ 3.81		150µ"/3.81µm Sn		
-185			SQ				.675/17.15		30µ"/0.76µm Au OVER 50µ"/1.27µm Ni		
-186	2x20		SQ	2.760/70.10	1.900/48.26	2.220/56.39	.675/17.15	2.36/59.94	150µ"/3.81µm Sn		
-187	2x25		RND	3.260/82.80	2.400/60.96	2.720/69.09	.105/ 2.67	2.86/72.64	30µ"/0.76µm Au OVER 50µ"/1.27µm Ni		
-188			SQ				.105/ 2.67		150µ"/3.81µm Sn		
-189			RND				.150/ 3.81		30µ"/0.76µm Au OVER 50µ"/1.27µm Ni		
-190			SQ				.150/ 3.81		150µ"/3.81µm Sn		
-191			SQ				.675/17.15		30µ"/0.76µm Au OVER 50µ"/1.27µm Ni		
-192	2x25		SQ	3.260/ 82,8	2.400/60,960	2.720/69.09	.675/17.15	2.86/72.64	150µ"/3.81µm Sn		
-193	2x30		RND	3.760/ 95,5	2.900/73,660	3.220/81.79	.105/ 2.67	3.36/85.34	30µ"/0.76µm Au OVER 50µ"/1.27µm Ni		
-194			SQ				.105/ 2.67		150µ"/3.81µm Sn		
-195			RND				.150/ 3.81		30µ"/0.76µm Au OVER 50µ"/1.27µm Ni		
-196			SQ				.150/ 3.81		150µ"/3.81µm Sn		
-197			SQ				.675/17.15		30µ"/0.76µm Au OVER 50µ"/1.27µm Ni		
-198	2x30			3.760/ 95.50	2.900/73.66	3.220/81.79	.675/17.15	3.36/85.34	150µ"/3.81µm Sn	D	
-199	2x5			1.260/32.00	.400/10.16	.720/18.29	.105/ 2.67	.86/21.84	30µ"/0.76µm Au OVER 50µ"/1.27µm Ni	A	
-200	2x7			1.460/37.08	.600/15.24	.920/23.37		1.06/26.92		C	
-201	2x8			1.560/39.62	.700/17.78	1.020/25.91		1.16/29.46		D	
-202	2x10			1.760/44.70	.900/22.86	1.220/30.99		1.36/34.54			
-203	2x13			2.060/52.32	1.200/30.48	1.520/38.61		1.66/42.16			
-204	2x17			2.460/62.48	1.600/40.64	1.920/48.77		2.06/52.32			
-205	2x20			2.760/70.10	1.900/48.26	2.220/56.39		2.36/59.94			
-206	2x25			3.260/82.80	2.400/60.96	2.720/69.09		2.86/72.64			
-207	2x30		SQ	3.760/95.50	2.900/73.66	3.220/81.79	.105/ 2.67	3.36/85.34	30µ"/0.76µm Au OVER 50µ"/1.27µm Ni	D	
-208	2x5		RND	1.260/32.00	.400/10.16	.720/18.29	.150/ 3.81	.86/21.84	30µ"/0.76µm GXT WITH Au FLASH	A	
-209	2x7			1.460/37.08	.600/15.24	.920/23.37		1.06/26.92		C	
-210	2x8			1.560/39.62	.700/17.78	1.020/25.91		1.16/29.46		D	
-211	2x10			1.760/44.70	.900/22.86	1.220/30.99		1.36/34.54			
-212	2x13			2.060/52.32	1.200/30.48	1.520/38.61		1.66/42.16			
-213	2x17			2.460/62.48	1.600/40.64	1.920/48.77		2.06/52.32			
-214	2x20			2.760/70.10	1.900/48.26	2.220/56.39		2.36/59.94			
-215	2x25			3.260/ 82.80	2.400/60.96	2.720/69.09		2.86/72.64			
66429-216	2x30	LP	RND	3.760/95.50	2.900/73.66	3.220/81.79	.150/ 3,81	3,36/85,34	30µ"/0.76µm GXT WITH Au FLASH	D	PBT BLUE

Tous droits strictement reserves. Reproduction ou communication a des tiers interdite sous quelque forme que ce soit sans autorisation ecrite du proprietaire. Propriete de c FCI. Droits de reproduction FCI.



All rights strictly reserved. Reproduction or issue to third parties in any form whatever is not permitted without written authority from the proprietor. Property of FCI. Copyright FCI.

mat'l. code --				tolerances unless otherwise specified		CUSTOMER COPY		www.fciconnect.com		
ltr	ecn no	dr	date	linear	.XX ±.01/.X±.3		projection	title		
X					.XXX ±.005/.XX±.13					HEADER, QUICKIE
					.XXXX ±.0020/.XXX±.051					SEA-HORSE, RIGHT-ANGLE
				angles	0° ±2°		INCH/MM	product family		
				dr	J.W.BAIR	7/9/90		HEADER		
				enr	M.SYMK	7/9/90		code		
				chr	M.SYMK	7/9/90		-		
				appd	M.SYMK	7/9/90	scale	size dwg no		
sheet index		revision sheet				1:1		A 66429		
								sheet 9 of		

PRODUCT NO.	SIZE	LATCHES NOTE 9	PIN SHAPE	DIM A	DIM B	DIM C	DIM D	DIM E	TERMINAL PLATING NOTE 19	STYLE	HSG MATERIAL
66429-217	2x5	ND	RND	1.260/32.00	.400/10.16	.720/18.29	.105/ 2.67	.86/21.84	30µ"/0.76µm GXT WITH Au FLASH	A	PBT BLUE
-218	2x7			1.460/37.08	.600/15.24	.920/23.37		1.06/26.92		C	
-219	2x8			1.560/39.62	.700/17.78	1.020/25.91		1.16/29.46		D	
-220	2x10			1.760/44.70	.900/22.86	1.220/30.99		1.36/34.54			
-221	2x13			2.060/52.32	1.200/30.48	1.520/38.61		1.66/42.16			
-222	2x17			2.460/62.48	1.600/40.64	1.920/48.77		2.06/52.32			
-223	2x20			2.760/70.10	1.900/48.26	2.220/56.39		2.36/59.94			
-224	2x25			3.260/82.80	2.400/60.96	2.720/69.09		2.86/72.64			
-225	2x30		RND	3.760/95.50	2.900/73.66	3.220/81.79	.105/ 2.67	3.36/85.34		D	
-226	2x5		SQ	1.260/32.00	.400/10.16	.720/18.29	.675/17.15	.86/21.84		A	
-227	2x7			1.460/37.08	.600/15.24	.920/23.37		1.06/26.92		C	
-228	2x8			1.560/39.62	.700/17.78	1.020/25.91		1.16/29.46		D	
-229	2x10			1.760/44.70	.900/22.86	1.220/30.99		1.36/34.54			
-230	2x13			2.060/52.32	1.200/30.48	1.520/38.61		1.66/42.16			
-231	2x17			2.460/62.48	1.600/40.64	1.920/48.77		2.06/52.32			
-232	2x20			2.760/70.10	1.900/48.26	2.220/56.39		2.36/59.94			
-233	2x25			3.260/ 82,8	2.400/60.96	2.720/69.09		2.86/72.64			
-234	2x30	ND	SQ	3.760/ 95,5	2.900/73.66	3.220/81.79	.675/17.15	3.36/85.34		D	
-235	2x5	STD	RND	1.260/ 32	.400/10.16	.720/18.29	.105/ 2.67	.86/21.84		A	
-236	2x7			1.460/37,08	.600/15.24	.920/23.37		1.06/26.92		C	
-237	2x8			1.560/39,62	.700/17.78	1.020/25.91		1.16/29.46		D	
-238	2x10			1.760/ 44,7	.900/22.86	1.220/30.99		1.36/34.54			
-239	2x13			2.060/52,32	1.200/30.48	1.520/38.61		1.66/42.16			
-240	2x17			2.460/62,48	1.600/40.64	1.920/48.77		2.06/52.32			
-241	2x20			2.760/ 70,1	1.900/48.26	2.220/56.39		2.36/59.94			
-242	2x25			3.260/ 82,8	2.400/60.96	2.720/69.09		2.86/72.64			
-243	2x30		RND	3.760/ 95,5	2.900/73.66	3.220/81.79	.105/ 2.67	3.36/85.34		D	
-244	2x5		SQ	1.260/ 32	.400/10.16	.720/18,29	.675/17.15	.86/21.84		A	
-245	2x7			1.460/37,08	.600/15.24	.920/23.37		1.06/26.92		C	
-246	2x8			1.560/39,62	.700/17.78	1.020/25.91		1.16/29.46		D	
-247	2x10			1.760/ 44,7	.900/22.86	1.220/30.99		1.36/34.54			
-248	2x13			2.060/52,32	1.200/30.48	1.520/38.61		1.66/42.16			
-249	2x17			2.460/62,48	1.600/40.64	1.920/48.77		2.06/52.32			
-250	2x20			2.760/ 70,10	1.900/48.26	2.220/56.39		2.36/59.94			
-251	2x25			3.260/82.80	2.400/60.96	2.720/69.09		2.86/72.64			
66429-252	2x30	STD	SQ	3.760/95.50	2.900/73.66	3.220/81.79	.675/17,15	3.36/85.34	30µ"/0.76µm GXT WITH Au FLASH	D	PBT BLUE

Tous droits strictement reserves. Reproduction ou communication a des tiers interdite sous quelque forme que ce soit sans autorisation ecrite du proprietaire. Propriete de c FCI. Droits de reproduction FCI.



All rights strictly reserved. Reproduction or issue to third parties in any form whatever is not permitted without written authority from the proprietor. Property of FCI. Copyright FCI.

mat'l. code		tolerances unless otherwise specified		CUSTOMER COPY		www.fciconnect.com	
ltr	ecn no	dr	date	linear	.XX ±.01/.X±.3	projection	title
X					.XXX ±.005/.XX±.13		HEADER, QUICKIE
				angles	.XXX ±.0020/.XXX±.051	INCH/MM	SEA-HORSE, RIGHT-ANGLE
				dr	0' ±2'	scale	product family
				enr	J.W.BAIR 7/9/90	1:1	HEADER
				chr	M.SYMK 7/9/90	A	size dwg no
				appd	M.SYMK 7/9/90		66429
sheet index	revision sheet						code
							-
							sheet 10 of

PRODUCT NO.	SIZE	LATCHES NOTE 9	PIN SHAPE	DIM A	DIM B	DIM C	DIM D	DIM E	TERMINAL PLATING NOTE 19	STYLE	HSG MATERIAL
66429-253	2x5	LP	RND	1.260/32.00	.400/10.16	.720/18.29	.105/2.67	.86/21.84	30µ"/0.76µM GXT WITH Au FLASH	A	PBT BLUE
-254	2x7			1.460/37.08	.600/15.24	.920/23.37		1.06/26.92		C	
-255	2x8			1.560/39.62	.700/17.78	1.020/25.91		1.16/29.46		D	
-256	2x10			1.760/44.70	.900/22.86	1.220/30.99		1.36/34.54			
-257	2x13			2.060/52.32	1.200/30.48	1.520/38.61		1.66/42.16			
-258	2x17			2.460/62.48	1.600/40.64	1.920/48.77		2.06/52.32			
-259	2x20			2.760/70.10	1.900/48.26	2.220/56.39		2.36/59.94			
-260	2x25			3.260/82.80	2.400/60.96	2.720/69.09		2.86/72.64			
-261	2x30		RND	3.760/95.50	2.900/73.66	3.220/81.79	.105/2.67	3.36/85.34		D	
-262	2x5		SQ	1.260/32.00	.400/10.16	.720/18.29	.675/17.15	.86/21.84		A	
-263	2x7			1.460/37.08	.600/15.24	.920/23.37		1.06/26.92		C	
-264	2x8			1.560/39.62	.700/17.78	1.020/25.91		1.16/29.46		D	
-265	2x10			1.760/44.70	.900/22.86	1.220/30.99		1.36/34.54			
-266	2x13			2.060/52.32	1.200/30.48	1.520/38.61		1.66/42.16			
-267	2x17			2.460/62.48	1.600/40.64	1.920/48.77		2.06/52.32			
-268	2x20			2.760/70.10	1.900/48.26	2.220/56.39		2.36/59.94			
-269	2x25			3.260/82.80	2.400/60.96	2.720/69.09		2.86/72.64			
-270	2x30	LP	SQ	3.760/95.50	2.900/73.66	3.220/81.79	.675/17.15	3.36/85.34	30µ"/0.76µM GXT WITH Au FLASH	D	
-271	2x5	NO	RND	1.260/32.00	.400/10.16	.720/18.29	.105/ 2.67	.86/21.84	15µ"/0.3876µM GXT 50µ"/1.27µm Ni	A	
-272	2x7			1.460/37.08	.600/15.24	.920/23.37		1.06/26.92		C	
-273	2x8			1.560/39.62	.700/17.78	1.020/25.91		1.16/29.46		D	
-274	2x10			1.760/44.70	.900/22.86	1.220/30.99		1.36/34.54			
-275	2x13			2.060/52.32	1.200/30.48	1.520/38.61		1.66/42.16			
-276	2x17			2.460/62.48	1.600/40.64	1.920/48.77		2.06/52.32			
-277	2x20			2.760/70.10	1.900/48.26	2.220/56.39		2.36/59.94			
-278	2x25			3.260/82.80	2.400/60.96	2.720/69.09		2.86/72.64			
-279	2x30			3.760/95.50	2.900/73.66	3.220/81.79	.105/ 2.67	3.36/85.34		D	
-280	2x5			1.260/32.00	.400/10.16	.720/18.29	.150/ 3.81	.86/21.84		A	
-281	2x7			1.460/37.08	.600/15.24	.920/23.37		1.06/26.92		C	
-282	2x8			1.560/39.62	.700/17.78	1.020/25.91		1.16/29.46		D	
-283	2x10			1.760/44.70	.900/22.86	1.220/30.99		1.36/34.54			
-284	2x13			2.060/52.32	1.200/30.48	1.520/38.61		1.66/42.16			
-285	2x17			2.460/62.48	1.600/40.64	1.920/48.77		2.06/52.32			
-286	2x20			2.760/70.10	1.900/48.26	2.220/56.39		2.36/59.94			
-287	2x25			3.260/82.80	2.400/60.96	2.720/69.09		2.86/72.64			
66429-288	2x30	NO	RND	3.760/95.50	2.900/73.66	3.220/81.79	.150/ 3.81	3.36/85.34	15µ"/0.3876µM GXT 50µ"/1.27µm Ni	D	PBT BLUE

Tous droits strictement reserves. Reproduction ou communication a des tiers interdite sous quelque forme que ce soit sans autorisation ecrite du proprietaire. Propriete de c FCI. Droits de reproduction FCI.



All rights strictly reserved. Reproduction or issue to third parties in any form whatever is not permitted without written authority from the proprietor. Property of FCI. Copyright FCI.

mat'l. code				tolerances unless otherwise specified				CUSTOMER COPY		www.fciconnect.com	
ltr	ecn no	dr	date	linear	.XX ±.01/.X±.3			projection	title		
X					.XXX ±.005/.XX±.13						
					.XXX ±.0020/.XXX±.051				HEADER, QUICKIE SEA-HORSE, RIGHT-ANGLE		
				angles	0° ±2°			INCH/MM	product family		code
				dr	J.W.BAIR	7/9/90	HEADER				
				enr	M.SYMK	7/9/90	size		dwg no		
				chr	M.SYMK	7/9/90	A		66429		
				appd	M.SYMK	7/9/90	scale	1:1		sheet	11 of
sheet index	revision sheet										

PRODUCT NO.	SIZE	LATCHES NOTE 9	PIN SHAPE	DIM A	DIM B	DIM C	DIM D	DIM E	TERMINAL PLATING NOTE 19	STYLE	HSG MATERIAL
66429-289	2x5	NO	SQ	1.260/32.00	.400/10.16	.720/18.29	.675/17.15	.86/21.84	15µ"/0.38µm Au OVER 50µ"/1.27µm Ni	A	PBT BLUE
↑ -290	2x7	↑	↑	1.460/37.08	.600/15.24	.920/23.37	↑	1.06/26.92	↑	C	↑
-291	2x8	↑	↑	1.560/39.62	.700/17.78	1.020/25.91	↑	1.16/29.46	↑	D	↑
-292	2x10	↑	↑	1.760/44.70	.900/22.86	1.220/30.99	↑	1.36/34.54	↑	↑	↑
-293	2x13	↑	↑	2.060/52.32	1.200/30.48	1.520/38.61	↑	1.66/42.16	↑	↑	↑
-294	2x17	↑	↑	2.460/62.48	1.600/40.64	1.920/48.77	↑	2.06/52.32	↑	↑	↑
-295	2x20	↑	↑	2.760/70.10	1.900/48.26	2.220/56.39	↑	2.36/59.94	↑	↑	↑
-296	2x25	↓	↓	3.260/82.80	2.400/60.96	2.720/69.09	↓	2.86/72.64	↓	↓	↓
-297	2x30	NO	SQ	3.760/95.50	2.900/73.66	3.220/81.79	.675/17.15	3.36/85.34	↑	D	↑
-298	2x5	STD	RND	1.260/32.00	.400/10.16	.720/18.29	.105/ 2.67	.86/21.84	↑	A	↑
-299	2x7	↑	↑	1.460/37.08	.600/15.24	.920/23.37	↑	1.06/26.92	↑	C	↑
-300	2x8	↑	↑	1.560/39.62	.700/17.78	1.020/25.91	↑	1.16/29.46	↑	D	↑
-301	2x10	↑	↑	1.760/44.70	.900/22.86	1.220/30.99	↑	1.36/34.54	↑	↑	↑
-302	2x13	↑	↑	2.060/52.32	1.200/30.48	1.520/38.61	↑	1.66/42.16	↑	↑	↑
-303	2x17	↑	↑	2.460/62.48	1.600/40.64	1.920/48.77	↑	2.06/52.32	↑	↑	↑
-304	2x20	↑	↑	2.760/70.10	1.900/48.26	2.220/56.39	↑	2.36/59.94	↑	↑	↑
-305	2x25	↑	↑	3.260/82.80	2.400/60.96	2.720/69.09	↑	2.86/72.64	↑	↑	↑
-306	2x30	↑	↑	3.760/95.50	2.900/73.66	3.220/81.79	.105/2.67	3.36/85.34	↑	D	↑
-307	2x5	↑	↑	1.260/32.00	.400/10.16	.720/18.29	.150/3.81	.86/21.84	↑	A	↑
-308	2x7	↑	↑	1.460/37.08	.600/15.24	.920/23.37	↑	1.06/26.92	↑	C	↑
-309	2x8	↑	↑	1.560/39.62	.700/17.78	1.020/25.91	↑	1.16/29.46	↑	D	↑
↓ -310	2x10	↓	↓	1.760/44.70	.900/22.86	1.220/30.99	↓	1.36/34.54	↓	↑	↓
-311	2x13	↓	↓	2.060/52.32	1.200/30.48	1.520/38.61	↓	1.66/42.16	↓	↑	↓
-312	2x17	↓	↓	2.460/62.48	1.600/40.64	1.920/48.77	↓	2.06/52.32	↓	↑	↓
-313	2x20	↓	↓	2.760/70.10	1.900/48.26	2.220/56.39	↓	2.36/59.94	↓	↑	↓
-314	2x25	↓	↓	3.260/82.80	2.400/60.96	2.720/69.09	↓	2.86/72.64	↓	↑	↓
-315	2x30	↓	RND	3.760/95.50	2.900/73.66	3.220/81.79	.150/3.81	3.36/85.34	↓	D	↓
-316	2x5	↓	SQ	1.260/32.00	.400/10.16	.720/18.29	.675/17.15	.86/21.84	↓	A	↓
-317	2x7	↓	↑	1.460/37.08	.600/15.24	.920/23.37	↑	1.06/26.92	↓	C	↓
-318	2x8	↓	↑	1.560/39.62	.700/17.78	1.020/25.91	↑	1.16/29.46	↓	D	↓
-319	2x10	↓	↑	1.760/44.70	.900/22.86	1.220/30.99	↑	1.36/34.54	↓	↑	↓
-320	2x13	↓	↑	2.060/52.32	1.200/30.48	1.520/38.61	↑	1.66/42.16	↓	↑	↓
-321	2x17	↓	↑	2.460/62.48	1.600/40.64	1.920/48.77	↑	2.06/52.32	↓	↑	↓
-322	2x20	↓	↑	2.760/70.10	1.900/48.26	2.220/56.39	↑	2.36/59.94	↓	↑	↓
↓ -323	2x25	↓	↓	3.260/82.80	2.400/60.96	2.720/69.09	↓	2.86/72.64	↓	↑	↓
66429-324	2x30	STD	SQ	3.760/95.50	2.900/73.66	3.220/81.79	.675/17.15	3.36/85.34	15µ"/0.38µm Au OVER 50µ"/1.27µm Ni	D	PBT BLUE

Tous droits strictement reserves. Reproduction ou communication a des tiers interdite sous quelque forme que ce soit sans autorisation ecrite du proprietaire. Propriete de c FCI. Droits de reproduction FCI.



All rights strictly reserved. Reproduction or issue to third parties in any form whatever is not permitted without written authority from the proprietor. Property of FCI. Copyright FCI.

mat'l. code		--		tolerances unless otherwise specified		CUSTOMER COPY		 www.fciconnect.com	
ltr	ecn no	dr	date	linear	.XX ±.01/.X±.3	projection	title		
X					.XXX ±.005/.XX±.13		HEADER, QUICKIE		
				angles	.XXX ±.0020/.XXX±.051	INCH/MM	SEA-HORSE, RIGHT-ANGLE		
				dr	0° ±2°	scale	product family	code	
				enr	J.W.BAIR 7/9/90	1:1	HEADER		
				chr	M.SYMK 7/9/90	A	size	dwg no	
				appd	M.SYMK 7/9/90		66429	sheet	
sheet index	revision sheet							12 of	

PRODUCT NO.	SIZE	LATCHES NOTE 9	PIN SHAPE	DIM A	DIM B	DIM C	DIM D	DIM E	TERMINAL PLATING NOTE 19	STYLE	HSG MATERIAL		
66429-325	2x5	LP	RND	1.260/32.00	.400/10.16	.720/18.29	.105/ 2.67	.86/21.84	15µ"/0.38µm Au OVER 50µ"/1.27µm Ni	A	PBT BLUE		
-326	2x7			1.460/37.08	.600/15.24	.920/23.37		1.06/26.92		C			
-327	2x8			1.560/39.62	.700/17.78	1.020/25.91		1.16/29.46		D			
-328	2x10			1.760/44.70	.900/22.86	1.220/30.99		1.36/34.54					
-329	2x13			2.060/52.32	1.200/30.48	1.520/38.61		1.66/42.16					
-330	2x17			2.460/62.48	1.600/40.64	1.920/48.77		2.06/52.32					
-331	2x20			2.760/70.10	1.900/48.26	2.220/56.39		2.36/59.94					
-332	2x25			3.260/82.80	2.400/60.96	2.720/69.09		2.86/72.64					
-333	2x30			3.760/95.50	2.900/73.66	3.220/81.79	.105/ 2.67	3.36/85.34		D			
-334	2x5			1.260/32.00	.400/10.16	.720/18.29	.150/ 3.81	.86/21.84		A			
-335	2x7			1.460/37.08	.600/15.24	.920/23.37		1.06/26.92		C			
-336	2x8			1.560/39.62	.700/17.78	1.020/25.91		1.16/29.46		D			
-337	2x10			1.760/44.70	.900/22.86	1.220/30.99		1.36/34.54					
-338	2x13			2.060/52.32	1.200/30.48	1.520/38.61		1.66/42.16					
-339	2x17			2.460/62.48	1.600/40.64	1.920/48.77		2.06/52.32					
-340	2x20			2.760/70.10	1.900/48.26	2.220/56.39		2.36/59.94					
-341	2x25			3.260/82.80	2.400/60.96	2.720/69.09		2.86/72.64					
-342	2x30		RND	3.760/95.50	2.900/73.66	3.220/81.79	.150/3.81	3.36/85.34		D			
-343	2x5		SQ	1.260/32.00	.400/10.16	.720/18.29	.675/17.15	.86/21.84		A			
-344	2x7			1.460/37.08	.600/15.24	.920/23.37		1.06/26.92		C			
-345	2x8			1.560/39.62	.700/17.78	1.020/25.91		1.16/29.46		D			
-346	2x10			1.760/44.70	.900/22.86	1.220/30.99		1.36/34.54					
-347	2x13			2.060/52.32	1.200/30.48	1.520/38.61		1.66/42.16					
-348	2x17			2.460/62.48	1.600/40.64	1.920/48.77		2.06/52.32					
-349	2x20			2.760/70.10	1.900/48.26	2.220/56.39		2.36/59.94					
-350	2x25			3.260/82.80	2.400/60.96	2.720/69.09		2.86/72.64					
-351	2x30	LP	SQ	3.760/95.50	2.900/73.66	3.220/81.79	.675/17.15	3.36/85.34	15µ"/0.38µm Au OVER 50µ"/1.27µm Ni	D			
-352				UNAVAILABLE									
-353				UNAVAILABLE									
-354				UNAVAILABLE									
-355				UNAVAILABLE									
-356				UNAVAILABLE									
-357				UNAVAILABLE									
-358				UNAVAILABLE									
-359				UNAVAILABLE									
66429-360				UNAVAILABLE									PBT BLUE

Tous droits strictement reserves. Reproduction ou communication a des tiers interdite sous quelque forme que ce soit sans autorisation ecrite du proprietaire. Propriete de c FCI. Droits de reproduction FCI.



All rights strictly reserved. Reproduction or issue to third parties in any form whatever is not permitted without written authority from the proprietor. Property of FCI. Copyright FCI.

mat'l. code		tolerances unless otherwise specified		CUSTOMER COPY		FCI www.fciconnect.com	
ltr	ecn no	dr	date	linear	.XX ±.01/.X±.3	projection	title
X					.XXX ±.005/.XX±.13		HEADER, QUICKIE
				angles	.xxx ±.0020/.xxx±.051	INCH/MM	SEA-HORSE, RIGHT-ANGLE
				dr	0' ±2'	scale	product family
				enr	J.W.BAIR 7/9/90	1:1	HEADER
				chr	M.SYMK 7/9/90	A	code
				appd	M.SYMK 7/9/90	66429	sheet
sheet index	revision sheet						13 of

PRODUCT NO.	SIZE	LATCHES NOTE 9	PIN SHAPE	DIM A	DIM B	DIM C	DIM D	DIM E	TERMINAL PLATING NOTE 19	STYLE	HSG MATERIAL
66429-361									U N A V A I L A B L E		PBT BLUE
-362	2x5	NO	RND	1.260/32.00	.400/10.16	.720/18.29	.105/ 2.67	.86/21.84	30μ"/0.76μm Au OVER 50μ"/1.27μm Ni	B	
-363		NO	RND						15μ"/0.38μm Au OVER 50μ"/1.27μm Ni		
-364		NO	RND						30μ"/0.76μm GXT WITH Au FLASH		
-365		NO	SQ						150μ"/3.81μm Sn		
-366		STD	RND						30μ"/0.76μm Au OVER 50μ"/1.27μm Ni		
-367		STD	RND						15μ"/0.38μm Au OVER 50μ"/1.27μm Ni		
-368		STD	RND						30μ"/0.76μm GXT WITH Au FLASH		
-369		STD	SQ						150μ"/3.81μm Sn		
-370		LP	RND						30μ"/0.76μm Au OVER 50μ"/1.27μm Ni		
-371		LP	RND						15μ"/0.38μm Au OVER 50μ"/1.27μm Ni		
-372		LP	RND						30μ"/0.76μm GXT WITH Au FLASH		
-373		LP	SQ				.105/ 2.67		150μ"/3.81μm Sn		
-374		NO	RND				.150/ 3.81		30μ"/0.76μm Au OVER 50μ"/1.27μm Ni		
-375		NO	RND						15μ"/0.38μm Au OVER 50μ"/1.27μm Ni		
-376		NO	RND						30μ"/0.76μm GXT WITH Au FLASH		
-377		NO	SQ						150μ"/3.81μm Sn		
-378		STD	RND						30μ"/0.76μm Au OVER 50μ"/1.27μm Ni		
-379		STD	RND						15μ"/0.38μm Au OVER 50μ"/1.27μm Ni		
-380		STD	RND						30μ"/0.76μm GXT WITH Au FLASH		
-381		STD	SQ						150μ"/3.81μm Sn		
-382		LP	RND						30μ"/0.76μm Au OVER 50μ"/1.27μm Ni		
-383		LP	RND						15μ"/0.38μm Au OVER 50μ"/1.27μm Ni		
-384		LP	RND						30μ"/0.76μm GXT WITH Au FLASH		
-385		LP	SQ				.150/3.81		150μ"/3.81μm Sn		
-386		NO	SQ				.675/17.15		30μ"/0.76μm Au OVER 50μ"/1.27μm Ni		
-387		NO							15μ"/0.38μm Au OVER 50μ"/1.27μm Ni		
-388		NO							30μ"/0.76μm GXT WITH Au FLASH		
-389		NO							150μ"/3.81μm Sn		
-390		STD							30μ"/0.76μm Au OVER 50μ"/1.27μm Ni		
-391		STD							15μ"/0.38μm Au OVER 50μ"/1.27μm Ni		
-392		STD							30μ"/0.76μm GXT WITH Au FLASH		
-393		STD							150μ"/3.81μm Sn		
-394		LP							30μ"/0.76μm Au OVER 50μ"/1.27μm Ni		
-395		LP							15μ"/0.38μm Au OVER 50μ"/1.27μm Ni		
66429-396	2x5	LP	SQ	1.260/32.00	.400/10.16	.720/18.29	.675/17.15	.86/21.84	30μ"/0.76μm GXT WITH Au FLASH	B	PBT BLUE

Tous droits strictement reserves. Reproduction ou communication a des tiers interdite sous quelque forme que ce soit sans autorisation ecrite du proprietaire. Propriete de c FCI. Droits de reproduction FCI.



All rights strictly reserved. Reproduction or issue to third parties in any form whatever is not permitted without written authority from the proprietor. Property of FCI. Copyright FCI.

mat'l. code				tolerances unless otherwise specified				CUSTOMER COPY		www.fciconnect.com	
ltr	ecn no	dr	date	.XX ±.01/.X±.3		projection		title		HEADER, QUICKIE SEA-HORSE, RIGHT-ANGLE	
X				.XXX ±.005/.XX±.13				product family		HEADER	
				.XXX ±.0020/.XXX±.051		INCH/MM		size		dwg no	
				0' ±2'		scale		A		66429	
				dr J.W.BAIR 7/9/90		1:1		sheet		14 of	
				enr M.SYMK 7/9/90							
				chr M.SYMK 7/9/90							
				appd M.SYMK 7/9/90							
sheet index	revision sheet										

PRODUCT NO.	SIZE	LATCHES NOTE 9	PIN SHAPE	DIM A	DIM B	DIM C	DIM D	DIM E	TERMINAL PLATING NOTE 19	STYLE	HSG MATERIAL
66429-397	2x5	LP	SQ	1.260/32.00	.400/10.16	.720/18.29	.675/17.15	.86/21.84	150µ"/3.81µm Sn	B	PBT BLUE
-398	2x10	66258-00	RND	1.760/44.70	.900/22.86	1.220/30.99	.105/2.67	1.36/34.54	30µ"/0.76µm Au OVER 50µ"/1.27µm Ni	D	
-399	2x5	NO	SQ	1.260/32.00	.400/10.16	.720/18.29	.105/2.67	.86/21.84	15µ"/0.38µm Au OVER 50µ"/1.27µm Ni	A	
-400		STD					.105/2.67				
-401		LP					.105/2.67				
-402		NO					.150/3.81				
-403		STD					.150/3.81				
-404		LP					.150/3.81			A	
-405		NO					.150/3.81			B	
-406		STD					.150/3.81				
-407		LP					.150/3.81				
-408		NO					.150/3.81				
-409		STD					.150/3.81				
-410	2x5	LP		1.260/32.00	.400/10.16	.720/18.29	.150/3.81	.86/21.84		B	
-411	2x7	NO		1.460/37.08	.600/15.24	.920/23.37	.105/2.67	1.06/26.92		C	
-412		STD					.105/2.67				
-413		LP					.105/2.67				
-414		NO					.150/3.81				
-415		STD					.150/3.81				
-416	2x7	LP		1.460/37.08	.600/15.24	.920/23.37	.150/3.81	1.06/26.92		C	
-417	2x8	NO		1.560/39.62	.700/17.78	1.020/25.91	.105/2.67	1.16/29.46		D	
-418		STD					.105/2.67				
-419		LP					.105/2.67				
-420		NO					.150/3.81				
-421		STD					.150/3.81				
-422	2x8	LP		1.560/39.62	.700/17.78	1.020/25.91	.150/3.81	1.16/29.46			
-423	2x10	NO		1.760/44.70	.900/22.86	1.220/30.99	.105/2.67	1.36/34.54			
-424		STD					.105/2.67				
-425		LP					.105/2.67				
-426		NO					.150/3.81				
-427		STD					.150/3.81				
-428	2x10	LP		1.760/44.70	.900/22.86	1.220/30.99	.150/3.81	1.36/34.54			
-429	2x13	NO		2.060/52.32	1.200/30.48	1.520/38.61	.105/2.67	1.66/42.16			
-430		STD					.105/2.67				
-431		LP					.105/2.67				
66429-432	2x13	NO	SQ	2.060/55.32	1.200/30.48	1.520/38.61	.150/3.81	1.66/42.16	15µ"/0.38µm Au OVER 50µ"/1.27µm Ni	D	PBT BLUE

Tous droits strictement reserves. Reproduction ou communication a des tiers
 interdite sous quelque forme que ce soit sans autorisation ecrite du proprietaire.
 Propriete de c FCI. Droits de reproduction FCI.



All rights strictly reserved. Reproduction or issue to third parties in any
 form whatever is not permitted without written authority from the proprietor.
 Property of FCI. Copyright FCI.

mat'l. code				tolerances unless otherwise specified				CUSTOMER COPY		www.fciconnect.com	
ltr	ecn no	dr	date	linear	.XX ±.01/.X±.3			projection	title		
X					.XXX ±.005/.XX±.13						
					.XXXX ±.0020/.XXX±.051				HEADER, QUICKIE SEA-HORSE, RIGHT-ANGLE		
				angles	0° ±2'			INCH/MM	product family		code
				dr	J.W.BAIR 7/9/90		HEADER		-		
				enr	M.SYMK 7/9/90		size		dwg no		
				chr	M.SYMK 7/9/90		A		66429		
				appd	M.SYMK 7/9/90		scale	1:1		sheet 15 of	
sheet index	revision sheet										

PRODUCT NO.	SIZE	LATCHES NOTE 9	PIN SHAPE	DIM A	DIM B	DIM C	DIM D	DIM E	TERMINAL PLATING NOTE 19	STYLE	HSG MATERIAL
66429-433	2x13	STD	SQ	2.060/52.32	1.200/30.48	1.520/38.61	.150/3.81	1.66/42.16	15µ"/.38µm Au OVER 50µ"/1.27µm Ni	D	PBT BLUE
-434	2x13	LP		2.060/52.32	1.200/30.48	1.520/38.61	.150/3.81	1.66/42.16			
-435	2x17	NO		2.460/62.48	1.600/40.64	1.920/48.77	.105/2.67	2.06/52.32			
-436		STD					.105/2.67				
-437		LP					.105/2.67				
-438		NO					.150/3.81				
-439		STD					.150/3.81				
-440	2x17	LP		2.460/62.48	1.600/40.64	1.920/48.77	.150/3.81	2.06/52.32			
-441	2x20	NO		2.760/70.10	1.900/48.26	2.220/56.39	.105/2.67	2.36/59.94			
-442		STD					.105/2.67				
-443		LP					.105/2.67				
-444		NO					.150/3.81				
-445		STD					.150/3.81				
-446	2x20	LP		2.760/70.10	1.900/48.26	2.220/56.39	.150/3.81	2.36/59.94			
-447	2x25	NO		3.260/82.80	2.400/60.96	2.720/69.09	.105/2.67	2.86/72.64			
-448		STD					.105/2.67				
-449		LP					.105/2.67				
-450		NO					.150/3.81				
-451		STD					.150/3.81				
-452	2x25	LP		3.260/82.80	2.400/60.96	2.720/69.09	.150/3.81	2.86/72.64			
-453	2x30	NO		3.760/95.50	2.900/73.66	3.220/81.79	.105/2.67	3.36/85.34			
-454		STD					.105/2.67				
-455		LP					.105/2.67				
-456		NO					.150/3.81				
-457		STD					.150/3.81				
-458	2x30	LP	SQ	3.760/95.50	2.900/73.66	3.220/81.79	.150/3.81	3.36/85.34			
-459	2x12	NO	RND	1.960/49.80	1.100/27.94	1.420/36.07	.105/2.67	1.56/39.62			
-460		STD									
-461		LP							15µ"/.38µm Au OVER 50µ"/1.27µm Ni		
-462		NO							30µ"/.76µm Au OVER 50µ"/1.27µm Ni		
-463		STD							30µ"/.76µm Au OVER 50µ"/1.27µm Ni		
-464		LP							30µ"/.76µm Au OVER 50µ"/1.27µm Ni		
-465		NO							30µ"/.76µm GXT WITH Au FLASH		
-466		STD							30µ"/.76µm GXT WITH Au FLASH		
-467		LP	RND						30µ"/.76µm GXT WITH Au FLASH		
66429-468	2x12	NO	SQ	1.960/49.8	1.100/27.940	1.420/36.07	.105/2.67	1.56/39.62	150µ"/3.81µm Sn	D	PBT BLUE

Tous droits strictement reserves. Reproduction ou communication a des tiers interdite sous quelque forme que ce soit sans autorisation ecrite du proprietaire. Propriete de c FCI. Droits de reproduction FCI.



All rights strictly reserved. Reproduction or issue to third parties in any form whatever is not permitted without written authority from the proprietor. Property of FCI. Copyright FCI.

mat'l. code --				tolerances unless otherwise specified		CUSTOMER COPY		www.fciconnect.com	
ltr	ecn no	dr	date	linear	.XX ±.01/.X±.3		projection	title	
X					.XXX ±.005/.XX±.13				
				angles	.xxxx ±.0020/.xxx±.051		INCH/MM	SEA-HORSE, RIGHT-ANGLE	
					0' ±2'				
				dr	J.W.BAIR	7/9/90	scale	A	66429
				enr	M.SYMK	7/9/90			
				chr	M.SYMK	7/9/90			
				appd	M.SYMK	7/9/90			
sheet index	revision sheet						1:1		code
									66429
									16 of

Tous droits strictement reserves. Reproduction ou communication a des tiers interdite sous quelque forme que ce soit sans autorisation ecrite du proprietaire. Propriete de c FCI. Droits de reproduction FCI.



All rights strictly reserved. Reproduction or issue to third parties in any form whatever is not permitted without written authority from the proprietor. Property of FCI. Copyright FCI.

PRODUCT NO.	SIZE	LATCHES NOTE 9	PIN SHAPE	DIM A	DIM B	DIM C	DIM D	DIM E	TERMINAL PLATING NOTE 19	STYLE	HSG MATERIAL
66429-469	2x12	STD	SQ	1.960/49.80	1.100/27.94	1.420/36.07	.105/2.67	1.56/39.62	150µ"/3.81µm Sn	D	PBT BLUE
-470		LP	SQ				.105/2.67		150µ"/3.81µm Sn		
-471		NO	RND				.150/3.81		15µ"/.38µm Au OVER 50µ"/1.27µm Ni		
-472		STD							15µ"/.38µm Au OVER 50µ"/1.27µm Ni		
-473		LP							15µ"/.38µm Au OVER 50µ"/1.27µm Ni		
-474		NO							30µ"/.76µm Au OVER 50µ"/1.27µm Ni		
-475		STD							30µ"/.76µm Au OVER 50µ"/1.27µm Ni		
-476		LP							30µ"/.76µm Au OVER 50µ"/1.27µm Ni		
-477		NO							30µ"/.76µm GXT WITH Au FLASH		
-478		STD							30µ"/.76µm GXT WITH Au FLASH		
-479		LP	RND						30µ"/.76µm GXT WITH Au FLASH		
-480		NO	SQ						150µ"/3.81µm Sn		
-481		STD							150µ"/3.81µm Sn		
-482		LP					.150/3.81		150µ"/3.81µm Sn		
-483		NO					.105/2.67		15µ"/.38µm Au OVER 50µ"/1.27µm Ni		
-484		STD							15µ"/.38µm Au OVER 50µ"/1.27µm Ni		
-485		LP							15µ"/.38µm Au OVER 50µ"/1.27µm Ni		
-486		NO							30µ"/.76µm Au OVER 50µ"/1.27µm Ni		
-487		STD					.105/2.67		30µ"/.76µm Au OVER 50µ"/1.27µm Ni		
-488		LP					.150/3.81		30µ"/.76µm Au OVER 50µ"/1.27µm Ni		
-489		NO					.150/3.81		15µ"/.38µm Au OVER 50µ"/1.27µm Ni		
-490		STD					.150/ 3,81		15µ"/.38µm Au OVER 50µ"/1.27µm Ni		
-491		LP					.675/17.15		15µ"/.38µm Au OVER 50µ"/1.27µm Ni		
-492		NO							15µ"/.38µm Au OVER 50µ"/1.27µm Ni		
-493		STD							15µ"/.38µm Au OVER 50µ"/1.27µm Ni		
-494		LP							15µ"/.38µm Au OVER 50µ"/1.27µm Ni		
-495		NO							30µ"/.76µm Au OVER 50µ"/1.27µm Ni		
-496		STD							30µ"/.76µm Au OVER 50µ"/1.27µm Ni		
-497		LP							30µ"/.76µm Au OVER 50µ"/1.27µm Ni		
-498		NO							30µ"/.76µm GXT WITH Au FLASH		
-499		STD							30µ"/.76µm GXT WITH Au FLASH		
-500		LP							30µ"/.76µm GXT WITH Au FLASH		
-501		NO							150µ"/3.81µm Sn		
-502		STD							150µ"/3.81µm Sn		
-503	2x12	LP	SQ	1.960/49.80	1.100/27.94	1.420/36.07	.675/17.15	1.56/39.62	150µ"/3.81µm Sn		
66429-504	2x15	NO	RND	2.260/57.40	1.400/35.56	1.720/43.69	.105/2.67	1.86/47.24	15µ"/.38µm Au OVER 50µ"/1.27µm Ni	D	PBT BLUE

mat'l. code				tolerances unless otherwise specified		CUSTOMER COPY		FCI www.fciconnect.com	
ltr	ecn no	dr	date	linear	.XX ±.01/.X±.3	projection	title		
X					.XXX ±.005/.XX±.13		HEADER, QUICKIE		
				angles	.xxx ±.0020/.xxx±.051		SEA-HORSE, RIGHT-ANGLE		
				dr	0' ±2'	INCH/MM	product family	HEADER	code
				enr	J.W.BAIR 7/9/90	scale	size	dwg no	sheet
				chr	M.SYMK 7/9/90	1:1	A	66429	17 of
				appd	M.SYMK 7/9/90				
sheet index	revision sheet								

PRODUCT NO.	SIZE	LATCHES NOTE 9	PIN SHAPE	DIM A	DIM B	DIM C	DIM D	DIM E	TERMINAL PLATING NOTE 19	STYLE	HSG MATERIAL
66429-505	2x15	STD	RND	2.260/ 57,4	1.400/35,560	1.720/43,69	.105/ 2,67	1.86/47,24	15µ"/.38µm Au OVER 50µ"/1.27µm Ni	D	PBT BLUE
-506		LP							15µ"/.38µm Au OVER 50µ"/1.27µm Ni		
-507		NO							30µ"/.76µm Au OVER 50µ"/1.27µm Ni		
-508		STD							30µ"/.76µm Au OVER 50µ"/1.27µm Ni		
-509		LP							30µ"/.76µm Au OVER 50µ"/1.27µm Ni		
-510		NO							30µ"/.76µm GXTWITH Au FLASH		
-511		STD							30µ"/.76µm GXTWITH Au FLASH		
-512		LP	RND						30µ"/.76µm GXTWITH Au FLASH		
-513		NO	SQ						150µ"/3.81µm Sn		
-514		STD	SQ						150µ"/3.81µm Sn		
-515		LP	SQ				.105/ 2,67		150µ"/3.81µm Sn		
-516		NO	RND				.150/ 3,81		15µ"/.38µm Au OVER 50µ"/1.27µm Ni		
-517		STD							15µ"/.38µm Au OVER 50µ"/1.27µm Ni		
-518		LP							15µ"/.38µm Au OVER 50µ"/1.27µm Ni		
-519		NO							30µ"/.76µm Au OVER 50µ"/1.27µm Ni		
-520		STD							30µ"/.76µm Au OVER 50µ"/1.27µm Ni		
-521		LP							30µ"/.76µm Au OVER 50µ"/1.27µm Ni		
-522		NO							30µ"/.76µm GXTWITH Au FLASH		
-523		STD							30µ"/.76µm GXTWITH Au FLASH		
-524		LP	RND						30µ"/.76µm GXTWITH Au FLASH		
-525		NO	SQ						150µ"/3.81µm Sn		
-526		STD							150µ"/3.81µm Sn		
-527		LP					.150/ 3,81		150µ"/3.81µm Sn		
-528		NO					.105/ 2,67		15µ"/.38µm Au OVER 50µ"/1.27µm Ni		
-529		STD							15µ"/.38µm Au OVER 50µ"/1.27µm Ni		
-530		LP							15µ"/.38µm Au OVER 50µ"/1.27µm Ni		
-531		NO							30µ"/.76µm Au OVER 50µ"/1.27µm Ni		
-532		STD							30µ"/.76µm Au OVER 50µ"/1.27µm Ni		
-533		LP					.105/ 2,67		30µ"/.76µm Au OVER 50µ"/1.27µm Ni		
-534		NO					.150/ 3,81		15µ"/.38µm Au OVER 50µ"/1.27µm Ni		
-535		STD					.150/ 3,81		15µ"/.38µm Au OVER 50µ"/1.27µm Ni		
-536		LP					.150/ 3,81		15µ"/.38µm Au OVER 50µ"/1.27µm Ni		
-537		NO					.675/17,15		15µ"/.38µm Au OVER 50µ"/1.27µm Ni		
-538		STD							15µ"/.38µm Au OVER 50µ"/1.27µm Ni		
-539		LP							15µ"/.38µm Au OVER 50µ"/1.27µm Ni		
66429-540	2x15	NO	SQ	2.260/ 57,4	1.400/35,560	1.720/43,69	.675/17,15	1.86/47,24	30µ"/.76µm Au OVER 50µ"/1.27µm Ni	D	PBT BLUE

Tous droits strictement reserves. Reproduction ou communication a des tiers interdite sous quelque forme que ce soit sans autorisation ecrite du proprietaire. Propriete de c FCI. Droits de reproduction FCI.



All rights strictly reserved. Reproduction or issue to third parties in any form whatever is not permitted without written authority from the proprietor. Property of FCI. Copyright FCI.

mat'l. code		--		tolerances unless otherwise specified		CUSTOMER COPY		www.fciconnect.com	
ltr	ecn no	dr	date	linear	.XX ±.01/.X±.3	projection	title		
X					.XXX ±.005/.XX±.13		HEADER, QUICKIE		
				angles	.xxx ±.0020/.xxx±.051		SEA-HORSE, RIGHT-ANGLE		
				dr	0° ±2'	INCH/MM	product family	code	
				enr	J.W.BAIR 7/9/90	scale	HEADER		
				chr	M.SYMK 7/9/90	1:1	size	dwg no	
				appd	M.SYMK 7/9/90	A	66429		sheet
sheet index	revision sheet								18 of

PRODUCT NO.	SIZE	LATCHES NOTE 9	PIN SHAPE	DIM A	DIM B	DIM C	DIM D	DIM E	TERMINAL PLATING NOTE 19	STYLE	HSG MATERIAL
66429-541	2x15	STD	SQ	2.260/ 57.40	1.400/35.56	1.720/43.69	.675/17.15	1.86/47.24	30µ"/.76µm Au OVER 50µ"/1.27µm Ni	D	PBT BLUE
-542		LP							30µ"/.76µm Au OVER 50µ"/1.27µm Ni		
-543		NO							30µ"/.76µm GXTWITH Au FLASH		
-544		STD							30µ"/.76µm GXTWITH Au FLASH		
-545		LP							30µ"/.76µm GXTWITH Au FLASH		
-546		NO							150µ"/3.81µm Sn		
-547		STD							150µ"/3.81µm Sn		
-548	2x15	LP	SQ	2.260/57.40	1.400/35.56	1.720/43.69	.675/17.15	1.86/47.24	150µ"/3.81µm Sn		
-549	2x22	NO	RND	2.960/75.20	2.100/53.34	2.420/61.47	.105/2.06	2.56/65.02	15µ"/.38µm Au OVER 50µ"/1.27µm Ni		
-550		STD							15µ"/.38µm Au OVER 50µ"/1.27µm Ni		
-551		LP							15µ"/.38µm Au OVER 50µ"/1.27µm Ni		
-552		NO							30µ"/.76µm Au OVER 50µ"/1.27µm Ni		
-553		STD							30µ"/.76µm Au OVER 50µ"/1.27µm Ni		
-554		LP							30µ"/.76µm Au OVER 50µ"/1.27µm Ni		
-555		NO							30µ"/.76µm GXTWITH Au FLASH		
-556		STD							30µ"/.76µm GXTWITH Au FLASH		
-557		LP	RND						30µ"/.76µm GXTWITH Au FLASH		
-558		NO	SQ						150µ"/3.81µm Sn		
-559		STD	SQ						150µ"/3.81µm Sn		
-560		LP	SQ				.105/2.67		150µ"/3.81µm Sn		
-561		NO	RND				.150/3.81		15µ"/.38µm Au OVER 50µ"/1.27µm Ni		
-562		STD							15µ"/.38µm Au OVER 50µ"/1.27µm Ni		
-563		LP							15µ"/.38µm Au OVER 50µ"/1.27µm Ni		
-564		NO							30µ"/.76µm Au OVER 50µ"/1.27µm Ni		
-565		STD							30µ"/.76µm Au OVER 50µ"/1.27µm Ni		
-566		LP							30µ"/.76µm Au OVER 50µ"/1.27µm Ni		
-567		NO							30µ"/.76µm GXTWITH Au FLASH		
-568		STD							30µ"/.76µm GXTWITH Au FLASH		
-569		LP	RND						30µ"/.76µm GXTWITH Au FLASH		
-570		NO	SQ						150µ"/3.81µm Sn		
-571		STD							150µ"/3.81µm Sn		
-572		LP					.150/3.81		150µ"/3.81µm Sn		
-573		NO					.105/2.67		15µ"/.38µm Au OVER 50µ"/1.27µm Ni		
-574		STD							15µ"/.38µm Au OVER 50µ"/1.27µm Ni		
-575		LP							15µ"/.38µm Au OVER 50µ"/1.27µm Ni		
66429-576	2x22	NO	SQ	2.960/ 75,2	2.100/53,340	2.420/61,47	.105/ 2,67	2.56/65,02	30µ"/.76µm Au OVER 50µ"/1.27µm Ni	D	PBT BLUE

Tous droits strictement reserves. Reproduction ou communication a des tiers interdite sous quelque forme que ce soit sans autorisation ecrite du proprietaire. Propriete de c FCI. Droits de reproduction FCI.



All rights strictly reserved. Reproduction or issue to third parties in any form whatever is not permitted without written authority from the proprietor. Property of FCI. Copyright FCI.

mat'l. code --				tolerances unless otherwise specified		CUSTOMER COPY		www.fciconnect.com			
ltr	ecn no	dr	date	linear	.XX ±.01/.X±.3	projection		title			
X					.XXX ±.005/.XX±.13			HEADER, QUICKIE		SEA-HORSE, RIGHT-ANGLE	
					.XXX ±.0020/.XXX±.051			product family		HEADER	
				angles	0° ±2'	INCH/MM		size			
				dr	J.W.BAIR 7/9/90	scale		A			
				enr	M.SYMK 7/9/90	1:1		66429			
				chr	M.SYMK 7/9/90			sheet			
				appd	M.SYMK 7/9/90			19 of			
sheet index	revision sheet										

PRODUCT NUMBER	SIZE	LATCHES NOTE 9	PIN SHAPE	DIM A	DIM B	DIM C	DIM D	DIM E	TERMINAL PLATING NOTE 19	STYLE	HSG MATERIAL
66429-577	2x22	STD	SQ	2.960/75.18	2.100/53.34	2.420/61.47	.105/2.67	2.56/65.02	30u"/.76u Au OVER 50u"/1.27u NI	D	PBT BLUE
-578		LP					.105/2.67		30u"/.76u Au OVER 50u"/1.27u NI		
-579		NO					.150/3.81		15u"/.38u Au OVER 50u"/1.27u NI		
-580		STD					.150/3.81		15u"/.38u Au OVER 50u"/1.27u NI		
-581		LP					.150/3.81		15u"/.38u Au OVER 50u"/1.27u NI		
-582		NO					.675/17.15		15u"/.38u Au OVER 50u"/1.27u NI		
-583		STD							15u"/.38u Au OVER 50u"/1.27u NI		
-584		LP							30u"/.76u Au OVER 50u"/1.27u NI		
-585		NO							30u"/.76u Au OVER 50u"/1.27u NI		
-586		STD							30u"/.76u Au OVER 50u"/1.27u NI		
-587		LP							30u"/.76u Au OVER 50u"/1.27u NI		
-588		NO							30u"/.76u GXT/GOLD FLASH		
-589		STD							30u"/.76u GXT/GOLD FLASH		
-590		LP							30u"/.76u GXT/GOLD FLASH		
-591		NO							150u"/3.18u Sn		
-592		STD							150u"/3.18u Sn		
-593	2x22	LP	SQ	2.960/75.18	2.100/53.34	2.420/61.47	.675/17.15	2.56/65.02	150u"/3.18u Sn	D	
-594	UNAVAILABLE										
-595	2x13	STD	RND	2.060/52.32	1.200/30.48	1.520/38.61	.105/2.67	1.66/42.2	50u"/1.27u Au OVER 50u"/1.27u NI	D	
-596	2x17	STD		2.460/62.48	1.600/40.64	1.920/48.77	.150/3.81	2.06/53.3		D	
-597	2x7	LP		1.460/37.08	.600/15.24	.920/23.67	.105/2.67	1.06/26.9		C	
-598	2x13	LP		2.060/52.32	1.200/30.48	1.520/38.61	.150/3.81	1.66/42.2		D	
-599	2x13	NO		2.060/52.32	1.200/30.48	1.520/38.61	.105/2.67	1.66/42.2		D	
-600	2x17	NO		2.460/62.48	1.600/40.64	1.920/48.77	.150/3.81	2.06/53.3		D	
-601	2x7	NO		1.460/37.08	.600/15.24	.920/23.67	.105/2.67	1.06/26.9		C	
-602	2x13	NO	RND	2.060/52.32	1.200/30.48	1.520/38.61	.150/3.81	1.66/42.2	50u"/1.27u Au OVER 50u"/1.27u NI	D	
-603	2x13	STD	SQ	2.060/52.32	1.200/30.48	1.520/38.61	.105/2.67	1.66/42.2	30u"/.76u GXT/GOLD FLASH	D	
-604	2x13	NO	SQ	2.060/52.32	1.200/30.48	1.520/38.61	.105/2.67	1.66/42.2	30u"/.76u GXT/GOLD FLASH	D	
-605	2x25	STD	SQ	3.260/82.80	2.400/60.69	2.720/69.09	.105/2.67	2.86/72.6	30u"/.76u GXT/GOLD FLASH	D	
-606	2x25	NO	SQ	3.260/82.80	2.400/60.69	2.720/69.09	.105/2.67	2.86/72.6	30u"/.76u GXT/GOLD FLASH	D	
-607	2x25	STD	RND	3.260/82.80	2.400/60.69	2.720/69.09	.105/2.67	2.86/72.6	30u"/.76u Au OVER 50u"/1.27u NI	E	
-608	2x25	NO	RND	3.260/82.80	2.400/60.69	2.720/69.09	.105/2.67	2.86/72.6	30u"/.76u Au OVER 50u"/1.27u NI	E	
-609	2x25	STD	RND	3.260/82.80	2.400/60.69	2.720/69.09	.105/2.67	2.86/72.6	30u"/.76u Au OVER 50u"/1.27u NI	E	
-610	2x25	NO	RND	3.260/82.80	2.400/60.69	2.720/69.09	.105/2.67	2.86/72.6	30u"/.76u Au OVER 50u"/1.27u NI	E	PBT BLUE
-611	2x25	STD	RND	3.260/82.80	2.400/60.69	2.720/69.09	.105/2.67	2.86/72.6	30u"/.76u Au OVER 50u"/1.27u NI	D	PBT BLACK
-612	2x25	NO	RND	3.260/82.80	2.400/60.69	2.720/69.09	.105/2.67	2.86/72.6	30u"/.76u Au OVER 50u"/1.27u NI	D	PBT BLACK
66429-734	2x17	LP	RND	2.460/62.48	1.600/40.64	1.920/48.77	.105/2.66	2.06/53.3	30u"/.76u Au OVER 50u"/1.27u NI	D	PCT BLACK

NOTE 13

NOTE 13

NOTE 14

NOTE 14

NOTE 15

Tous droits strictement reserves. Reproduction ou communication a des tiers interdite sous quelque forme que ce soit sans autorisation ecrite du proprietaire. Propriete de c FCI. Droits de reproduction FCI.



All rights strictly reserved. Reproduction or issue to third parties in any form whatever is not permitted without written authority from the Proprietor. Property of FCI. Copyright FCI.

mat'l. code		tolerances unless otherwise specified		CUSTOMER COPY		www.fciconnect.com	
ltr	ecn no	dr	date	linear	.XX ±.01/.X±.3	projection	
X					.XXX ±.005/.XX±.13		
				angles	.XXX ±.0020/.XXX±.051	scale	A
				dr	0° ±2'		
				enr	J.W.BAIR 7/9/90	product family	HEADER
				chr	M.SYMK 7/9/90		
				appd	M.SYMK 7/9/90	sheet	20 of
sheet index	revision sheet						