

- **64 × 1 Sensor-Element Organization**
- **200 Dots-Per-Inch (DPI) Sensor Pitch**
- **High Linearity and Uniformity**
- **Wide Dynamic Range . . . 2000:1 (66 dB)**
- **Output Referenced to Ground**
- **Low Image Lag . . . 0.5% Typ**
- **Operation to 5 MHz**
- **Single 5-V Supply**
- **Replacement for TSL201 and TSL201R**
- **RoHS Compliant**

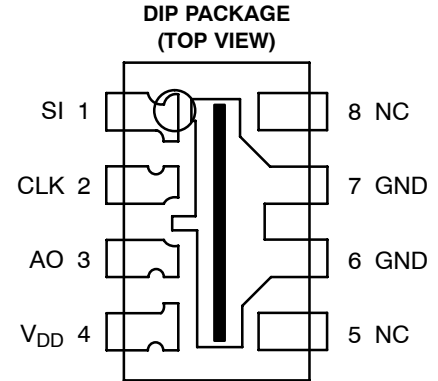

NC – No internal connection

Description

The TSL201R-LF linear sensor array consists of a 64 × 1 array of photodiodes and associated charge amplifier circuitry. The pixels measure 120 μm (H) by 70 μm (W) with 125-μm center-to-center spacing and 55-μm spacing between pixels. Operation is simplified by internal control logic that requires only a serial-input (SI) signal and a clock.

The TSL201R-LF is intended for use in a wide variety of applications including mark detection and code reading, optical character recognition (OCR) and contact imaging, edge detection and positioning as well as optical linear and rotary encoding.

Functional Block Diagram

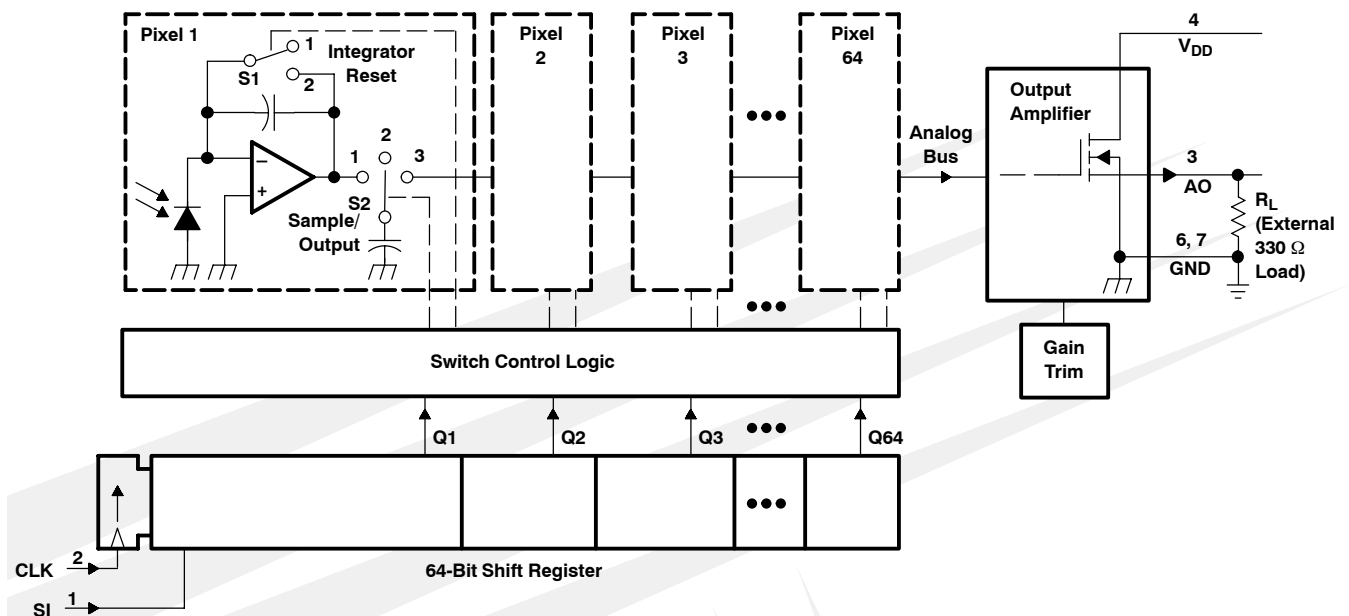

TSL201R-LF

64 × 1 LINEAR SENSOR ARRAY

TAOS077B – MAY 2007

Terminal Functions

TERMINAL		DESCRIPTION
NAME	NO.	
AO	3	Analog output.
CLK	2	Clock. The clock controls charge transfer, pixel output, and reset.
GND	6, 7	Ground (substrate). All voltages are referenced to the substrate.
SI	1	Serial input. SI defines the start of the data-out sequence.
V _{DD}	4	Supply voltage. Supply voltage for both analog and digital circuits.

Detailed Description

The sensor consists of 64 photodiodes arranged in a linear array. Light energy impinging on a photodiode generates photocurrent, which is integrated by the active integration circuitry associated with that pixel. During the integration period, a sampling capacitor connects to the output of the integrator through an analog switch. The amount of charge accumulated at each pixel is directly proportional to the light intensity and the integration time. The integration time is the interval between two consecutive output periods.

The output and reset of the integrators is controlled by a 64-bit shift register and reset logic. An output cycle is initiated by clocking in a logic 1 on SI for one positive going clock edge (see Figures 1 and 2) †. As the SI pulse is clocked through the 64-bit shift register, the charge on the sampling capacitor of each pixel is sequentially connected to a charge-coupled output amplifier that generates a voltage output, AO. When the bit position goes low, the pixel integrator is reset. On the 65th clock rising edge, the SI pulse is clocked out of the shift register and the output assumes a high-impedance state. Note that this 65th clock pulse is required to terminate the output of the 64th pixel and return the internal logic to a known state. A subsequent SI pulse can be presented as early as the 66th clock pulse, thereby initiating another pixel output cycle.

The voltage developed at analog output (AO) is given by:

$$V_{out} = V_{drk} + (R_e) (E_e) (t_{int})$$

where:

- V_{out} is the analog output voltage for white condition
- V_{drk} is the analog output voltage for dark condition
- R_e is the device responsivity for a given wavelength of light given in V/(μJ/cm²)
- E_e is the incident irradiance in μW/cm²
- t_{int} is integration time in seconds

AO is driven by a source follower that requires an external pulldown resistor (330-Ω typical). The output is nominally 0 V for no light input, 2 V for normal white-level, and 3.4 V for saturation light level. When the device is not in the output phase, AO is in a high impedance state.

A 0.1 μF bypass capacitor should be connected between V_{DD} and ground as close as possible to the device.

† For proper operation, after meeting the minimum hold time condition, SI must go low before the next rising edge of the clock.

Absolute Maximum Ratings†

Supply voltage range, V_{DD}	-0.3 V to 6 V
Input voltage range, V_I	-0.3 V to $V_{DD} + 0.3V$
Input clamp current, I_{IK} ($V_I < 0$ or $V_I > V_{DD}$)	-20 mA to 20 mA
Output clamp current, I_{OK} ($V_O < 0$ or $V_O > V_{DD}$)	-25 mA to 25 mA
Voltage range applied to any output in the high impedance or power-off state, V_O	-0.3 V to $V_{DD} + 0.3V$
Continuous output current, I_O ($V_O = 0$ to V_{DD})	-25 mA to 25 mA
Continuous current through V_{DD} or GND	-40 mA to 40 mA
Analog output current range, I_O	-25 mA to 25 mA
Operating free-air temperature range, T_A	-25°C to 85°C
Storage temperature range, T_{stg}	-25°C to 85°C
Lead temperature 1,6 mm (1/16 inch) from case for 10 seconds‡	260°C
ESD tolerance, human body model	2000 V

† Stresses beyond those listed under “Absolute Maximum Ratings” may cause permanent damage to the device. These are stress ratings only, and functional operation of the device at these or any other conditions beyond those indicated under “Recommended Operating Conditions” is not implied. Exposure to absolute-maximum-rated conditions for extended periods may affect device reliability.

‡ Not recommended for solder reflow.

Recommended Operating Conditions (see Figure 1 and Figure 2)

	MIN	NOM	MAX	UNIT
Supply voltage, V_{DD}	4.5	5	5.5	V
Input voltage, V_I	0		V_{DD}	V
High-level input voltage, V_{IH}	2		V_{DD}	V
Low-level input voltage, V_{IL}	0		0.8	V
Wavelength of light source, λ	400		1000	nm
Clock frequency, f_{clock}	5		5000	kHz
Sensor integration time, t_{int}	0.017		100	ms
Operating free-air temperature, T_A	0		70	°C
Load resistance, R_L	300		4700	Ω
Load capacitance, C_L			470	pF

TSL201R-LF

64 × 1 LINEAR SENSOR ARRAY

TAOS077B – MAY 2007

Electrical Characteristics at $f_{\text{clock}} = 1 \text{ MHz}$, $V_{\text{DD}} = 5 \text{ V}$, $T_{\text{A}} = 25^{\circ}\text{C}$, $\lambda_{\text{p}} = 640 \text{ nm}$, $t_{\text{int}} = 5 \text{ ms}$, $R_{\text{L}} = 330 \ \Omega$, $E_{\text{e}} = 16.5 \ \mu\text{W}/\text{cm}^2$ (unless otherwise noted)

PARAMETER		TEST CONDITIONS	MIN	TYP	MAX	UNIT
V_{out}	Analog output voltage (white, average over 64 pixels)	see Note 1	1.6	2	2.4	V
V_{drk}	Analog output voltage (dark, average over 64 pixels)	$E_{\text{e}} = 0$	0	50	120	mV
PRNU	Pixel response nonuniformity	See Notes 2 & 3		±4%	±7.5%	
	Nonlinearity of analog output voltage	See Note 3		±0.4%		FS
	Output noise voltage	See Note 4		1		mVrms
R_{e}	Responsivity (See Note 5)		18	23		V/ ($\mu\text{J}/\text{cm}^2$)
SE	Saturation exposure	See Note 6		142		nJ/cm ²
V_{sat}	Analog output saturation voltage		2.5	3.4		V
DSNU	Dark signal nonuniformity	All pixels, $E_{\text{e}} = 0$ See Note 7		25	120	mV
IL	Image lag	See Note 8		0.5%		
I_{DD}	Supply current, output idle			3.4	5	mA
I_{IH}	High-level input current	$V_{\text{I}} = V_{\text{DD}}$			1	μA
I_{IL}	Low-level input current	$V_{\text{I}} = 0$			1	μA
$C_{\text{i(SI)}}$	Input capacitance, SI			5		pF
$C_{\text{i(CLK)}}$	Input capacitance, CLK			5		pF

- NOTES:
- The array is uniformly illuminated with a diffused LED source having a peak wavelength of 640 nm.
 - PRNU is the maximum difference between the voltage from any single pixel and the average output voltage from all pixels of the device under test when the array is uniformly illuminated at the white irradiance level. PRNU includes DSNU.
 - Nonlinearity is defined as the maximum deviation from a best-fit straight line over the dark-to-white irradiance levels, as a percent of analog output voltage (white).
 - RMS noise is the standard deviation of a single-pixel output under constant illumination as observed over a 5-second period.
 - $R_{\text{e(min)}} = [V_{\text{out(min)}} - V_{\text{drk(max)}}] \div (E_{\text{e}} \times t_{\text{int}})$
 - Minimum saturation exposure is calculated using the minimum V_{sat} , the maximum V_{drk} , and the maximum R_{e} .
 - DSNU is the difference between the maximum and minimum output voltage in the absence of illumination.
 - Image lag is a residual signal left in a pixel from a previous exposure. It is defined as a percent of white-level signal remaining after a pixel is exposed to a white condition followed by a dark condition:

$$IL = \frac{V_{\text{out(IL)}} - V_{\text{drk}}}{V_{\text{out(white)}} - V_{\text{drk}}} \times 100$$

Timing Requirements (see Figure 1 and Figure 2)

		MIN	NOM	MAX	UNIT
$t_{\text{su(SI)}}$	Setup time, serial input (see Note 9)	20			ns
$t_{\text{h(SI)}}$	Hold time, serial input (see Note 9 and Note 10)	0			ns
t_{w}	Pulse duration, clock high or low	50			ns
t_{r} , t_{f}	Input transition (rise and fall) time	0		500	ns

- NOTES:
- Input pulses have the following characteristics: $t_{\text{r}} = 6 \text{ ns}$, $t_{\text{f}} = 6 \text{ ns}$.
 - SI must go low before the rising edge of the next clock pulse.

Dynamic Characteristics over recommended ranges of supply voltage and operating free-air temperature (see Figure 2)

PARAMETER		TEST CONDITIONS	MIN	TYP	MAX	UNIT
t_{s}	Analog output settling time to ±1%	$R_{\text{L}} = 330 \ \Omega$, $C_{\text{L}} = 10 \ \text{pF}$		185		ns

TYPICAL CHARACTERISTICS

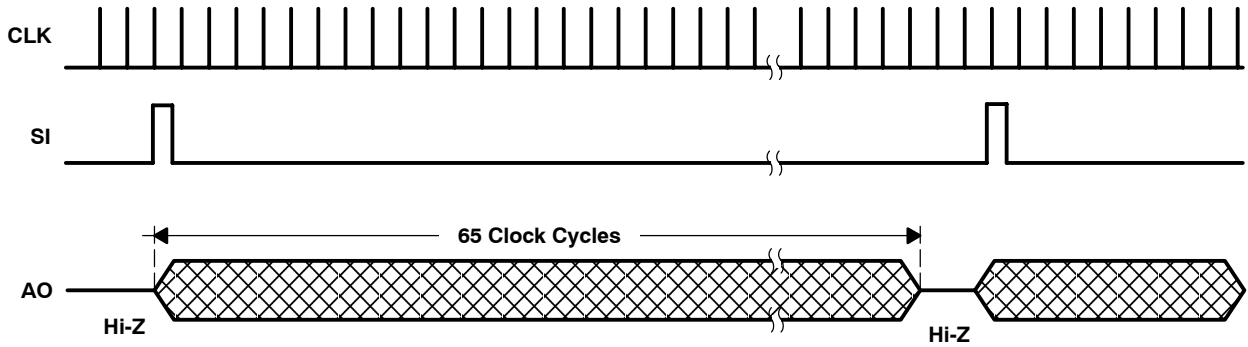

Figure 1. Timing Waveforms

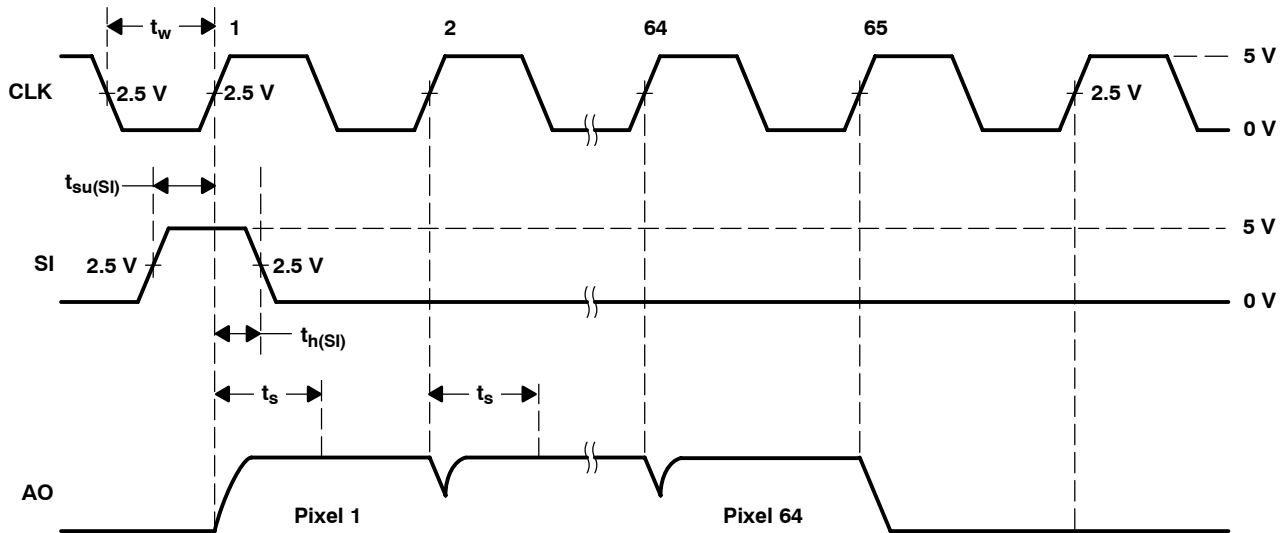

Figure 2. Operational Waveforms

TSL201R-LF

64 × 1 LINEAR SENSOR ARRAY

TAOS077B – MAY 2007

TYPICAL CHARACTERISTICS

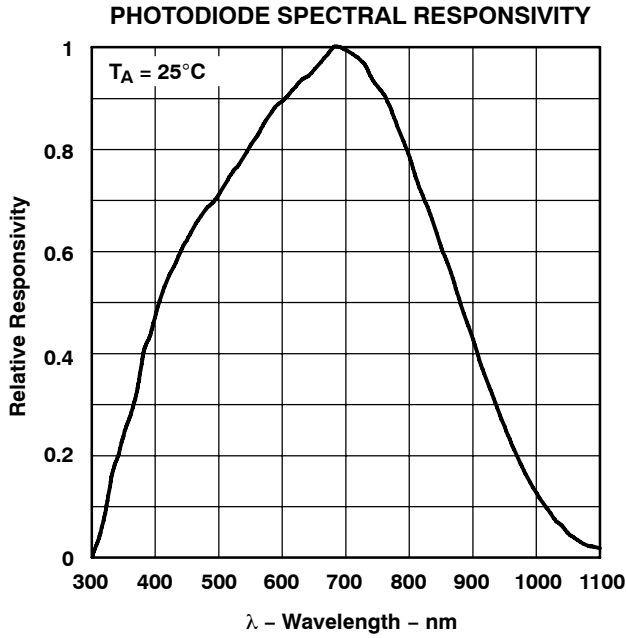

Figure 3

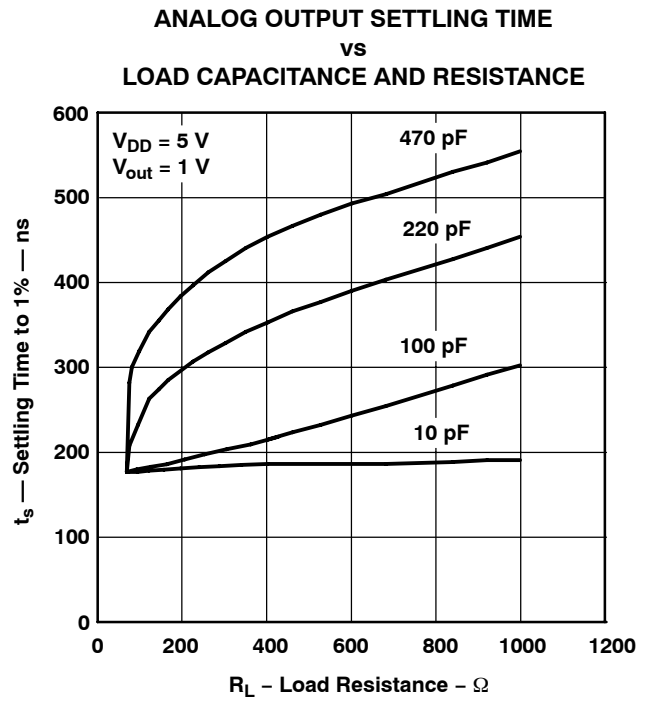

Figure 4

APPLICATION INFORMATION

Power Supply Considerations

For optimum device performance, power-supply lines should be decoupled by a 0.01-μF to 0.1-μF capacitor with short leads mounted close to the device package.

Integration Time

The integration time of the linear array is the period during which light is sampled and charge accumulates on each pixel's integrating capacitor. The flexibility to adjust the integration period is a powerful and useful feature of the TAOS TSL2xx linear array family. By changing the integration time, a desired output voltage can be obtained on the output pin while avoiding saturation for a wide range of light levels.

Each pixel of the linear array consists of a light-sensitive photodiode. The photodiode converts light intensity to a voltage. The voltage is sampled on the Sampling Capacitor by closing switch S2 (position 1) (see the functional block diagram on page 1). Logic controls the resetting of the Integrating Capacitor to zero by closing switch S1 (position 2).

At SI input (Start Integration), pixel 1 is accessed. During this event, S2 moves from position 1 (sampling) to position 3 (holding). This holds the sampled voltage for pixel 1. Switch S1 for pixel 1 is then moved to position 2. This resets (clears) the voltage previously integrated for that pixel so that pixel 1 is now ready to start a new integration cycle. When the next clock period starts, the S1 switch is returned to position 1 to be ready to start integrating again. S2 is returned to position 1 to start sampling the next light integration. Then the next pixel starts the same procedure. The integration time is the time from a specific pixel read to the next time that pixel is read again. If either the clock speed or the time between successive SI pulses is changed, the integration time will vary. After the final (n^{th}) pixel in the array is read on the output, the output goes into a high-impedance mode. A new SI pulse can occur on the ($n+1$) clock causing a new cycle of integration/output to begin. Note that the time between successive SI pulses must not exceed the maximum integration time of 100 msec.

The minimum integration time for any given array is determined by time required to clock out all the pixels in the array and the time to discharge the pixels. The time required to discharge the pixels is a constant. Therefore, the minimum integration period is simply a function of the clock frequency and the number of pixels in the array. A slower clock speed increases the minimum integration time and reduces the maximum light level for saturation on the output. The minimum integration time shown in this data sheet is based on the maximum clock frequency of 5 MHz.

The minimum integration time can be calculated from the equation:

$$T_{int(min)} = \left(\frac{1}{\text{maximum clock frequency}} \right) \times n$$

where:

n is the number of pixels

In the case of the TSL201R-LF, the minimum integration time would be:

$$T_{int(min)} = 200ns \times 64 = 12.8ns$$

It is important to note that not all pixels will have the same integration time if the clock frequency is varied while data is being output.

TSL201R-LF

64 × 1 LINEAR SENSOR ARRAY

TAOS077B – MAY 2007

APPLICATION INFORMATION

It is good practice on initial power up to run the clock ($n+1$) times after the first SI pulse to clock out indeterminate data from power up. After that, the SI pulse is valid from the time following ($n+1$) clocks. The output will go into a high-impedance state after the $n+1$ high clock edge. It is good practice to leave the clock in a low state when inactive because the SI pulse required to start a new cycle is a low-to-high transition.

The integration time chosen is valid as long as it falls in the range between the minimum and maximum limits for integration time. If the amount of light incident on the array during a given integration period produces a saturated output (Max Voltage output), then the data is not accurate. If this occurs, the integration period should be reduced until the analog output voltage for each pixel falls below the saturation level. The goal of reducing the period of time the light sampling window is active is to lower the output voltage level to prevent saturation. However, the integration time must still be greater than or equal to the minimum integration period.

If the light intensity produces an output below desired signal levels, the output voltage level can be increased by increasing the integration period provided that the maximum integration time is not exceeded. The maximum integration time is limited by the length of time the integrating capacitors on the pixels can hold their accumulated charge. The maximum integration time should not exceed 100 ms for accurate measurements.

Although the linear array is capable of running over a wide range of operating frequencies up to a maximum of 5 MHz, the speed of the A/D converter used in the application is likely to be the limiter for the maximum clock frequency. The voltage output is available for the whole period of the clock, so the setup and hold times required for the analog-to-digital conversion must be less than the clock period.

MECHANICAL INFORMATION

This dual-in-line package consists of an integrated circuit mounted on a lead frame and encapsulated in an electrically nonconductive clear plastic compound.

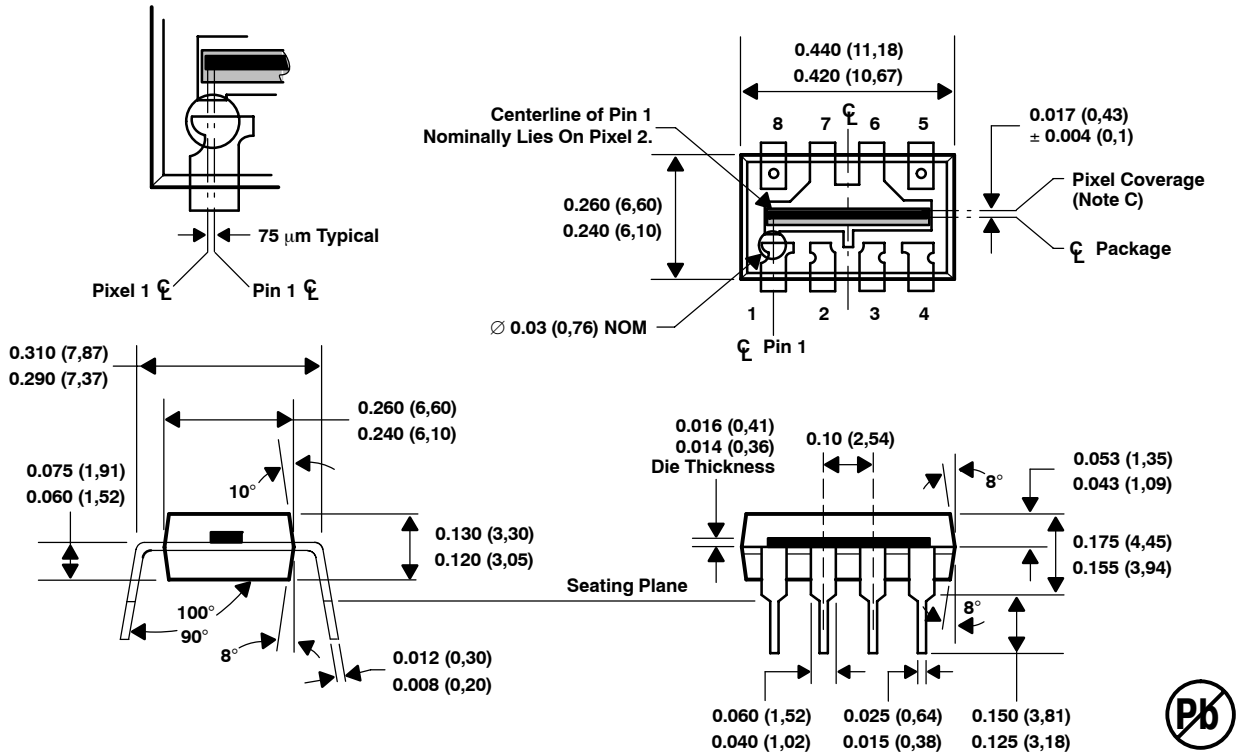

- NOTES: A. All linear dimensions are in inches and (millimeters).
 B. Index of refraction of clear plastic is 1.55.
 C. Center of pixel active areas typically located under this line.
 D. Lead finish is NiPd.
 E. This drawing is subject to change without notice.

Figure 5. Packaging Configuration

TSL201R-LF

64 × 1 LINEAR SENSOR ARRAY

TAOS077B – MAY 2007

PRODUCTION DATA — information in this document is current at publication date. Products conform to specifications in accordance with the terms of Texas Advanced Optoelectronic Solutions, Inc. standard warranty. Production processing does not necessarily include testing of all parameters.

LEAD-FREE (Pb-FREE) and GREEN STATEMENT

Pb-Free (RoHS) TAOS' terms *Lead-Free* or *Pb-Free* mean semiconductor products that are compatible with the current RoHS requirements for all 6 substances, including the requirement that lead not exceed 0.1% by weight in homogeneous materials. Where designed to be soldered at high temperatures, TAOS Pb-Free products are suitable for use in specified lead-free processes.

Green (RoHS & no Sb/Br) TAOS defines *Green* to mean Pb-Free (RoHS compatible), and free of Bromine (Br) and Antimony (Sb) based flame retardants (Br or Sb do not exceed 0.1% by weight in homogeneous material).

Important Information and Disclaimer The information provided in this statement represents TAOS' knowledge and belief as of the date that it is provided. TAOS bases its knowledge and belief on information provided by third parties, and makes no representation or warranty as to the accuracy of such information. Efforts are underway to better integrate information from third parties. TAOS has taken and continues to take reasonable steps to provide representative and accurate information but may not have conducted destructive testing or chemical analysis on incoming materials and chemicals. TAOS and TAOS suppliers consider certain information to be proprietary, and thus CAS numbers and other limited information may not be available for release.

NOTICE

Texas Advanced Optoelectronic Solutions, Inc. (TAOS) reserves the right to make changes to the products contained in this document to improve performance or for any other purpose, or to discontinue them without notice. Customers are advised to contact TAOS to obtain the latest product information before placing orders or designing TAOS products into systems.

TAOS assumes no responsibility for the use of any products or circuits described in this document or customer product design, conveys no license, either expressed or implied, under any patent or other right, and makes no representation that the circuits are free of patent infringement. TAOS further makes no claim as to the suitability of its products for any particular purpose, nor does TAOS assume any liability arising out of the use of any product or circuit, and specifically disclaims any and all liability, including without limitation consequential or incidental damages.

TEXAS ADVANCED OPTOELECTRONIC SOLUTIONS, INC. PRODUCTS ARE NOT DESIGNED OR INTENDED FOR USE IN CRITICAL APPLICATIONS IN WHICH THE FAILURE OR MALFUNCTION OF THE TAOS PRODUCT MAY RESULT IN PERSONAL INJURY OR DEATH. USE OF TAOS PRODUCTS IN LIFE SUPPORT SYSTEMS IS EXPRESSLY UNAUTHORIZED AND ANY SUCH USE BY A CUSTOMER IS COMPLETELY AT THE CUSTOMER'S RISK.

LUMENOLOGY, TAOS, the TAOS logo, and Texas Advanced Optoelectronic Solutions are registered trademarks of Texas Advanced Optoelectronic Solutions Incorporated.