

# 2000 Slide Switches - Snap fit and panel mount 10A 250Vac

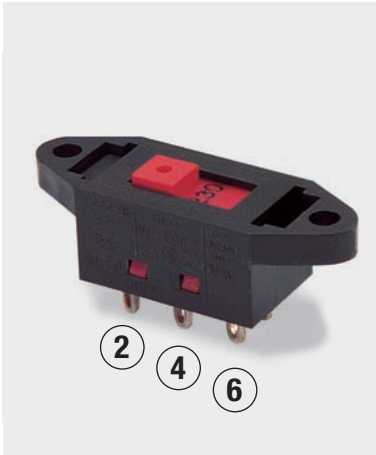

- ▶ 2 way 'voltage selector'
- ▶ Ratings up to 16A, 250V ac
- ▶ Snap fit and panel mount
- ▶ PCB & solder terminals
- ▶ 2 and 3 position
- ▶ Choice of circuits
- ▶ Choice of actuators

## Approvals and specifications



10 A 250Vac T85  
6(3)A 250Vac T85



UL CSA 16A 250Vac Non Inductive  
UL CSA 4A 300Vac  
UL 65°C, file no. E45221, CSA file no. LR10990

µ contact gap

Please specify: Standard action (SP116) or light action (SP118).  
2000 series lubrication is inorganic and does not degrade plastics.

Technical data on pages 4 & 5.

115/230 is preferred legend

**T 2 2 20 5 B ---**

TERMINAL SERIES POSITIONS CIRCUIT SLIDER BODY PRINT, COLOUR, ETC

TERMINAL	SERIES	POS'N	CIRCUIT <small>Viewed from back</small>	SLIDER				
<b>K</b>  2.8 x 0.8  <b>R</b>  2.8 x 0.8  <b>T</b>  Solder  <b>X</b>  PCB 0.8 Sq. For mounting stability switches have extra "support" terminals  * Nominal - Dimension varies with body type. For exact figure call sales	2	2	<b>10</b>   <b>20</b>   <b>30</b>   <b>40</b> 	<b>0</b> 2 Pos B Body only   <b>2</b> 2 Pos B Body only   <b>3</b> 2 & 3 Pos B Body only   <b>4</b> 2 & 3 Pos B Body only   <b>5</b> 2 Pos B Body only Also with legend 	<b>6</b> 2 & 3 Pos B Body only   <b>7</b> 2 & 3 Pos B Body only   <b>8</b> E Body only Legend optional   <b>9</b> 2 & 3 Pos B Body only 	<b>C</b> 2 & 3 Pos B Body only   <b>D</b> 2 & 3 Pos B Body only   <b>E</b> 2 Pos B Body only Limited travel on 2 pos   <b>H</b> 2 Pos B Body only 	<b>L</b> 2 & 3 Pos B Body only Limited travel on 2 pos   <b>M</b> F Body only Legend optional   <b>N</b> 2 Pos B Body only 	<b>S</b> Limited travel on 2 pos 2 & 3 Pos B Body only   <b>T</b> 2 & 3 Pos B Body only   <b>P</b> 2 & 3 Pos B Body only Limited travel on 2 pos   <b>R</b> 2 & 3 Pos B Body only 

slide switches



T22208E ---



T22308E ---



T2230MF ---



T22205B ---



T22305B ---



T23204B ---

**BODY**

**OPTIONS**

**B With mounting holes**

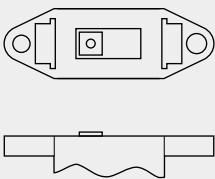

**Colour**

For custom slider colours call sales. A full range is available for large orders

Standard body colour is black

**Legend printing**

A wide range is available

**E Snap fit**

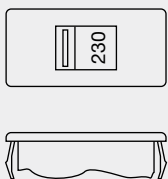

Cut-outs must be punched in the direction of insertion

For all options call sales

**F Snap fit (single pole ON OFF only)**

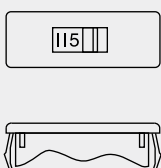

Cut-outs must be punched in the direction of insertion

**DIMENSIONS (mm)**

**Cut-out / PCB Matrix**

**2 Pos B**

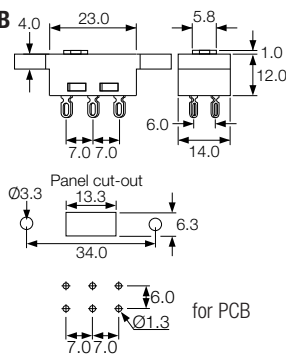

**3 Pos B**

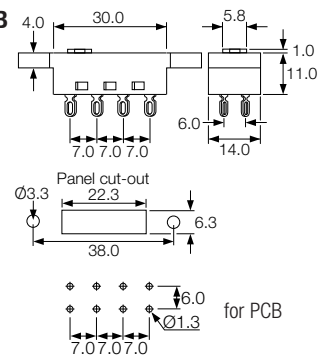

**2 Pos E**

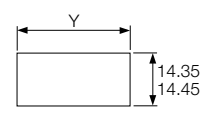
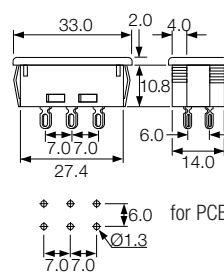

Panel thickness	Dim. Y
0.8-1.2	29.75/29.85
1.63	30.15/30.25
2.0	30.35/30.45
2.5	30.55/30.65

**2 Pos F**

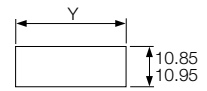
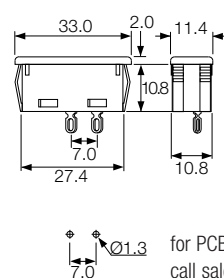

Panel thickness	Dim. Y
0.8-1.2	29.75/29.85
1.63	30.15/30.25
2.0	30.35/30.45
2.5	30.55/30.65

slide switches