



Features

- Lead free as standard
- RoHS compliant*
- Halogen free**
- ESD protection >25 kV
- Protects Vcc and two data lines

Applications

- Ethernet - 10/100/1000 Base T
- Firewire and USB
- Portable electronics
- Video/graphic cards

CD143A-SR05~12 – Steering/TVS Diode Array Series

General Information

The CD143A-SR05 and CD143A-SR12 devices provides ESD, EFT and surge protection for the external ports of portable electronic devices such as cell phones, handheld electronics and personal computers.

The ESD protection provided by the component enables a data port to withstand a minimum ± 8 KV Contact / ± 15 KV Air Discharge per the ESD test method specified in IEC 61000-4-2. The device measures 2.80 mm x 1.20 mm and is available in a SOT-143 package intended to be mounted directly onto an FR4 printed circuit board.

The Bourns® device will meet IEC 61000-4-2 (ESD), IEC 61000-4-4 (EFT) and IEC 61000-4-5 (Surge) requirements.

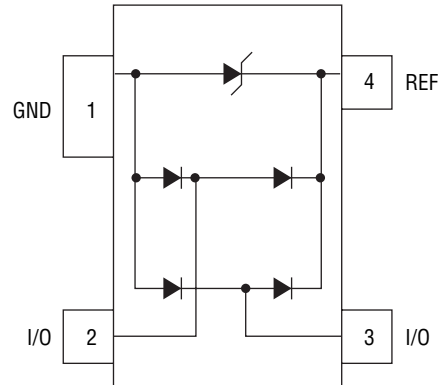

Absolute Maximum Ratings, $T_A = 25^\circ\text{C}$ (Unless Otherwise Noted)

Parameter	Symbol	Value	Unit
Peak Pulse Power ($t_p = 8/20 \mu\text{s}$) ¹	P_{PP}	500	W
Peak Pulse Current ($t_p = 8/20 \mu\text{s}$)	I_{PP}	30	A
-SR05		16	
-SR12			
Operating Temperature	T_J	-55°C to 150°C	$^\circ\text{C}$
Storage Temperature	T_{STG}	-55°C to 150°C	$^\circ\text{C}$
Peak Forward Voltage ($I_f = 1 \text{ A } 8/20 \mu\text{s}$)	V_F	1.5	V

Electrical Characteristics, $T_A = 25^\circ\text{C}$ (Unless Otherwise Noted)

Parameter	Symbol	CD143A-SR05	CD143A-SR12	Unit
Breakdown Voltage Minimum @ 1 mA ²	V_{BR}	6.0	13.3	V
Working Peak Voltage ²	V_{WM}	5.0	12	V
Clamping Voltage Maximum @ $I_P = 1 \text{ A}$ ^{2,3}	V_C	9.8	19	V
Clamping Voltage Maximum @ I_P ^{2,3}	V_C	20 @ 28 A	30 @ 16 A	V
Leakage Current @ V_{WM} ²	I_D	5.0	1.0	μA
Capacitance Maximum per Data Line @ 0 V, 1 MHz ^{4,5}	C_J	10	10	pF

Notes:

1. See Peak Pulse Power vs. Pulse Time.
2. From Pin 4 to Pin 1.
3. See Pulse Wave Form.
4. From Pin 1 to Pin 3, Pin 1 to Pin 2, Pin 3 to Pin 4, Pin 2 to Pin 4.
5. GND is connected to ground, REF is connected to $+V_{CC}$ and input applies to $V_{CC} = V_{WM}$, $V_{OSC} = 30 \text{ mV}$, $F = 1 \text{ MHz}$.

* RoHS Directive 2002/95/EC Jan 27, 2003 including Annex.

** Bourns follows the prevailing definition of "halogen free" in the industry. Bourns considers a product to be "halogen free" if (a) the Bromine (Br) content is 900 ppm or less; (b) the Chlorine (Cl) content is 900 ppm or less; and (c) the total Bromine (Br) and Chlorine (Cl) content is 1500 ppm or less.

Specifications are subject to change without notice.

Customers should verify actual device performance in their specific applications.

CD143A-SR05~12 – Steering/TVS Diode Array Series



Product Dimensions

This is a molded JEDEC SOT-143 device. It weighs approximately 35 mg and has a flammability rating of UL 94V-0. The dimensions for the packaged device are shown below.

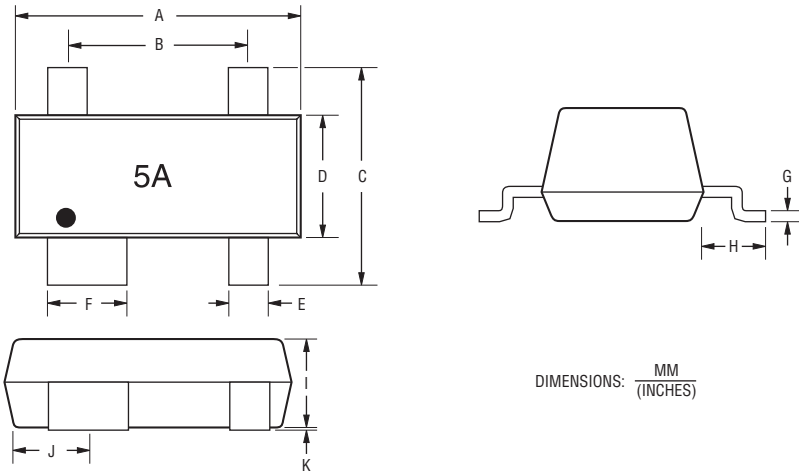

DIMENSIONS: $\frac{\text{MM}}{\text{(INCHES)}}$

Dimensions	
A	$\frac{2.80 - 3.04}{(0.110 - 0.12)}$
B	$\frac{1.78 - 2.03}{(0.070 - 0.080)}$
C	$\frac{2.11 - 2.48}{(0.083 - 0.098)}$
D	$\frac{1.20 - 1.39}{(0.047 - 0.055)}$
E	$\frac{0.39 - 0.50}{(0.015 - 0.020)}$
F	$\frac{0.79 - 0.93}{(0.031 - 0.037)}$
G	$\frac{0.08 - 0.15}{(0.003 - 0.006)}$
H	$\frac{0.46 - 0.60}{(0.018 - 0.024)}$
I	$\frac{0.84 - 1.14}{(0.033 - 0.045)}$
J	$\frac{0.72 - 0.83}{(0.028 - 0.033)}$
K	$\frac{0.013 - 0.10}{(0.0005 - 0.004)}$

Recommended Pad Layout

This is the footprint recommended for this SOT-143 device.

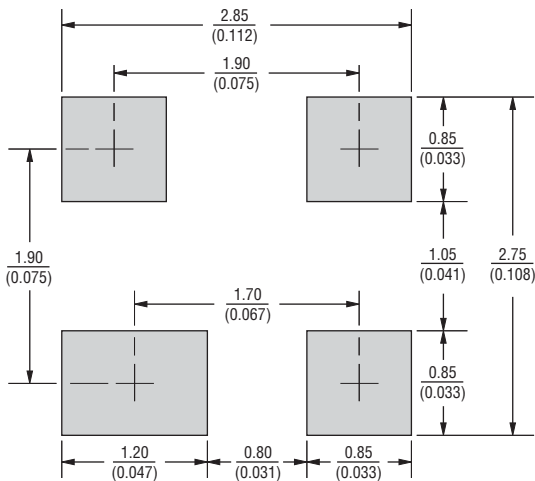

DIMENSIONS: $\frac{\text{MM}}{\text{(INCHES)}}$

Block Diagram

The device block diagram below includes the pin names and basic electrical connections associated with each channel.

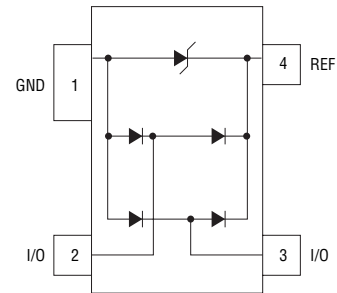

Typical Part Marking

CD143A-SR055A
 CD143A-SR1212A

CD143A-SR05~12 – Steering/TVS Diode Array Series



Performance Graphs

Peak Pulse Power vs Pulse Time

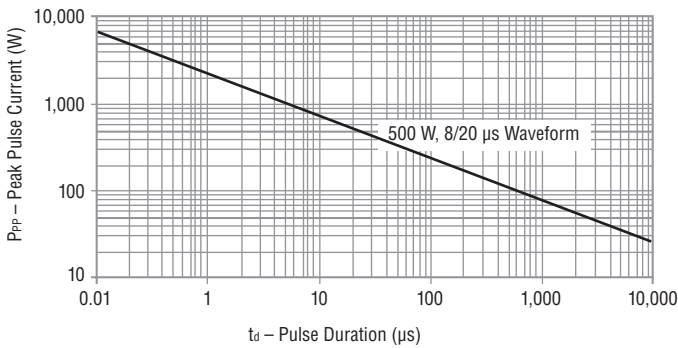

Pulse Wave Form

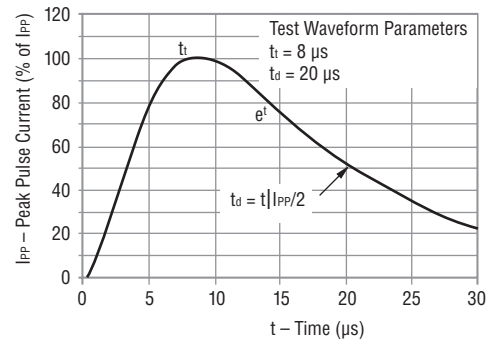

Typical Capacitance vs. Reverse Voltage

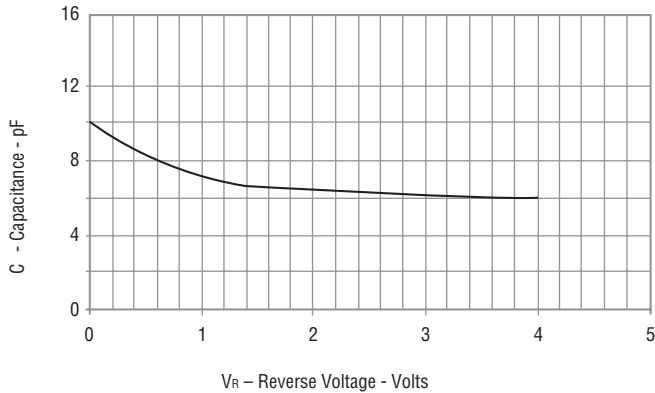

Power Derating Curve

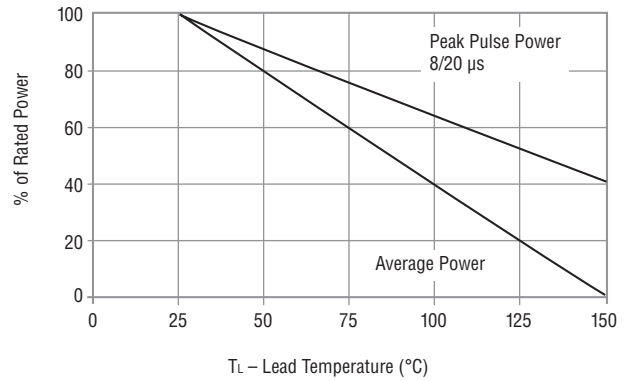

How To Order

