



- ⬢ IP68 when mated, tested in accordance with EN60529:1992+A2:2013
- ⬢ IP69K when mated, tested in accordance with DIN 40050/Part 9 IP6k9k
- ⬢ EN60068-2-52 Test Kb Salt Mist (Cyclic) Marine Severity Level 1
- ⬢ USB version 2.0 and 3.0 performance
- ⬢ Shielded system
- ⬢ Single and double ended cables
- ⬢ Screw coupling
- ⬢ PCB mounted panel connector
- ⬢ High-speed bus connection, USB 2.0: up to 480Mbps
USB 3.0: up to 5Gbps
- ⬢ Hot pluggable, USB 2.0 with 4 contact interface, USB 3.0 with 9 contact interface
- ⬢ Alignment indicator reduces risk of damage during mating
- ⬢ High noise immunity and EMI protection
- ⬢ Suitable for PC and peripheral configuration
- ⬢ Secure, proven locking system
- ⬢ Direct mounting or via adaptor leads
- ⬢ Plug and play capability

Sealed USB Cables - Single Ended



PX0840/A



PX0840/B



PX0840/AA

- Single ended sealed cable assembly
- IP68 'A' type USB 2.0 connector to standard 'A' or 'B' type USB 2.0 connector
- IP68 'B' type USB 2.0 connector to standard 'A' type USB 2.0 connector
- IP68 'A' type USB 3.0 connector to standard USB 3.0 'A' type connector
- Mates with all panel mount connectors
- USB 2.0 variants available in 2m, 3m & 5m lengths
- USB 3.0 variants available in 1m, 2m & 3m lengths

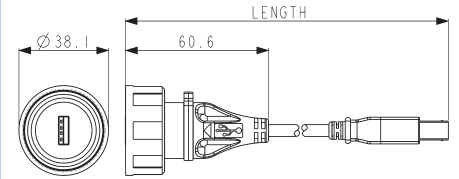

PX0840/A/xMxx

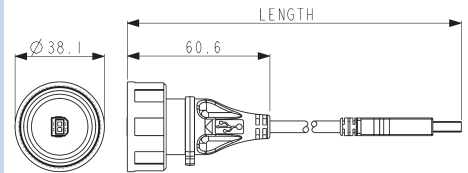

PX0840/B/xMxx

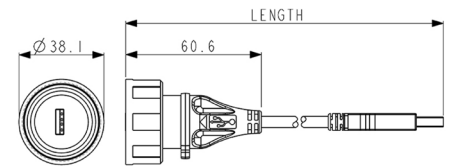

PX0840/AA/xMxx

Part no.	Length	Description
PX0840/A/2M00	2m	IP68 A type USB 2.0 to standard B type USB 2.0
PX0840/A/3M00	3m	IP68 A type USB 2.0 to standard B type USB 2.0
PX0840/A/5M00	5m	IP68 A type USB 2.0 to standard B type USB 2.0
PX0840/B/2M00	2m	IP68 B type USB 2.0 to standard A type USB 2.0
PX0840/B/3M00	3m	IP68 B type USB 2.0 to standard A type USB 2.0
PX0840/B/5M00	5m	IP68 B type USB 2.0 to standard A type USB 2.0
PX0840/AA/2M00	2m	IP68 A type USB 2.0 to standard A type USB 2.0
PX0840/AA/3M00	3m	IP68 A type USB 2.0 to standard A type USB 2.0
PX0840/AA/5M00	5m	IP68 A type USB 2.0 to standard A type USB 2.0
PX0840/A3/1M00	1m	IP68 A type USB 3.0 to standard A type USB 3.0
PX0840/A3/2M00	2m	IP68 A type USB 3.0 to standard A type USB 3.0
PX0840/A3/3M00	3m	IP68 A type USB 3.0 to standard A type USB 3.0

Sealed USB Cables Double Ended



PX0841/AA



PX0841/AB

- Double ended sealed cable assembly
- IP68 'A' type USB 2.0 connector to IP68 'A' or 'B' type USB 2.0 connector
- IP68 'A' type USB 3.0 connector to IP68 'A' type USB 3.0 connector
- Mates with all panel mount connectors
- USB 2.0 variants available in 2m, 3m & 5m lengths
- USB 3.0 variants available in 1m, 2m & 5m lengths

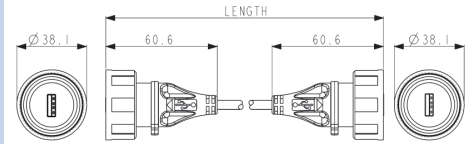

PX0841/AA/xMxx

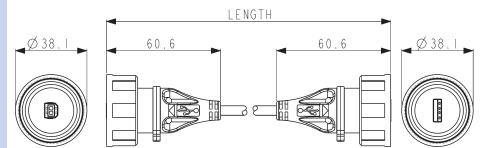

PX0841/AB/xMxx

Part no.	Length	Description
PX0841/AB/2M00	2m	IP68 A type USB 2.0 to IP68 B type USB 2.0
PX0841/AB/3M00	3m	IP68 A type USB 2.0 to IP68 B type USB 2.0
PX0841/AB/5M00	5m	IP68 A type USB 2.0 to IP68 B type USB 2.0
PX0841/AA/2M00	2m	IP68 A type USB 2.0 to IP68 A type USB 2.0
PX0841/AA/3M00	3m	IP68 A type USB 2.0 to IP68 A type USB 2.0
PX0841/AA/5M00	5m	IP68 A type USB 2.0 to IP68 A type USB 2.0
PX0841/A3/1M00	1m	IP68 A type USB 3.0 to IP68 A type USB 3.0
PX0841/A3/2M00	2m	IP68 A type USB 3.0 to IP68 A type USB 3.0
PX0841/A3/3M00	3m	IP68 A type USB 3.0 to IP68 A type USB 3.0

Front Panel Mounting Connector



PX0842/A

PX0842/B

- PX0842/A – USB 2.0 'A' type IP68 to USB 2.0 'B' type connector
- PX0842/AA – USB 2.0 'A' type IP68 to USB 2.0 'A' type connector
- PX0842/A3 – USB 3.0 'A' type IP68 to USB 3.0 'A' type connector
- PX0842/B – USB 2.0 'B' type IP68 to USB 2.0 'A' type connector
- Mates with PX0840 and PX0841 cable connectors

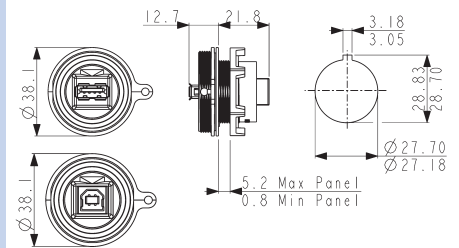

Part no.	Description
PX0842/A	IP68 A type USB 2.0, front panel mounted. Sealed A type at front of panel, standard B type at rear
PX0842/B	IP68 B type USB 2.0, front panel mounted. Sealed B type at front of panel, standard A type at rear
PX0842/AA	IP68 A type USB 2.0, front panel mounted. Sealed A type at front of panel, standard A type at rear
PX0842/A3	IP68 A type USB 3.0, front panel mounted. Sealed A type at front of panel, standard A type at rear

Front Panel Mounting Connector



PX0843/B

PX0843/A

- PX0843/A – USB 2.0 'A' type IP68 connector with 5-way crimp connector
- PX0843/B – USB 2.0 'B' type IP68 connector with 5-way crimp connector
- PX0843/A3 – USB 3.0 'A' type IP68 connector with 10-way crimp connector
- Mates with PX0840 and PX0841 cable connectors

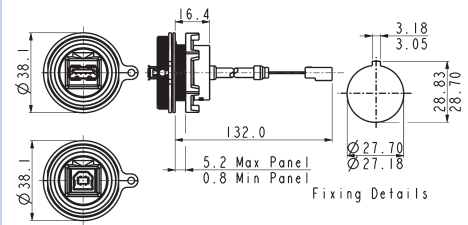

Part no.

Description

PX0843/A	IP68 A type USB 2.0, front panel mounted. Sealed A type at front of panel, 5 way crimp connector at rear.
PX0843/B	IP68 B type USB 2.0, front panel mounted. Sealed B type at front of panel, 5 way crimp connector at rear.
PX0843/A3	IP68 A type USB 3.0, front panel mounted. Sealed A type at front of panel, 10-way crimp connector at rear
PX0460/A	As PX0843/A with exposed braid for use with PX0465 screening can
PX0460/B	As PX0843/B with exposed braid for use with PX0465 screening can
PX0460/A3	As PX0843/A3 with exposed braid for use with PX0465 screening can

Front Panel Mounting Connector



PX0844/B

PX0844/A

- IP68 Sealed through panel
- PX0844/A – USB 2.0 'A' type IP68 connector
- PX0844/B – USB 2.0 'B' type IP68 connector
- PX0844/A3 – USB 3.0 'A' type IP68 connector
- Standard USB interface plug options to rear of panel
- 0.5m standard cable length, other lengths available
- Mates with PX0840 and PX0841 cable connectors

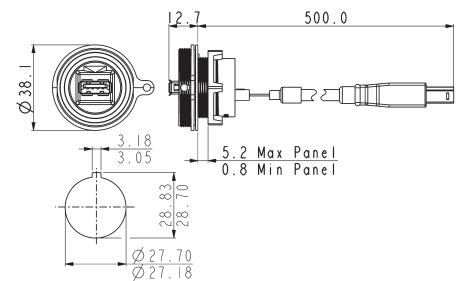

Part no.

Length

Description

PX0844/A/0M50/A	0.5m	IP68 A type USB 2.0, sealed through panel, Sealed 'A' type at front of panel, standard 'A' type at rear
PX0844/A/0M50/B	0.5m	IP68 A type USB 2.0, sealed through panel, Sealed 'A' type at front of panel, standard 'B' type at rear
PX0844/B/0M50/A	0.5m	IP68 B type USB 2.0, sealed through panel, Sealed 'B' type at front of panel, standard 'A' type at rear
PX0844/B/0M50/B	0.5m	IP68 B type USB 2.0, sealed through panel, Sealed 'B' type at front of panel, standard 'B' type at rear
PX0844/A3/0M50/A3	0.5m	IP68 B type USB 3.0, sealed through panel, Sealed 'A' type at front of panel, standard 'A' type at rear

Rear Panel Mounting Connector



PX0848/B

PX0848/A

- PX0848/A – USB 2.0 'A' type IP68 to USB 2.0 'B' type connector
- PX0848/B – USB 2.0 'B' type IP68 to USB 2.0 'A' type connector
- PX0848/A3 – USB 3.0 'A' type IP68 to USB 3.0 'A' type connector
- Mates with PX0840 and PX0841 cable connectors

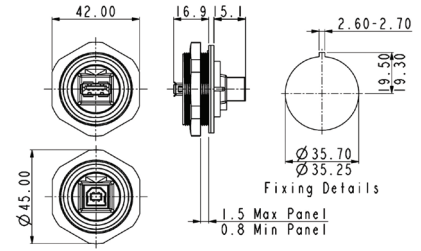

Part no. **Description**

PX0848/A	IP68 A type USB 2.0, rear panel mounted. Sealed A type at front of panel, standard B type at rear
PX0848/B	IP68 B type USB 2.0, rear panel mounted. Sealed B type at front of panel, standard A type at rear
PX0848/AA	IP68 A type USB 2.0, rear panel mounted. Sealed A type at front of panel, standard A type at rear
PX0848/A3	IP68 A type USB 3.0, rear panel mounted. Sealed A type at front of panel, standard A type at rear

Rear Panel Mounting Connector



PX0849/B

PX0849/A

- PX0849/A - USB 2.0 'A' type IP68 connector with 5-way crimp connector
- PX0849/B - USB 2.0 'B' type IP68 connector with 5-way crimp connector
- PX0849/A3 - USB 3.0 'B' type IP68 connector with 10-way crimp connector
- Mates with PX0840 and PX0841 cable connectors

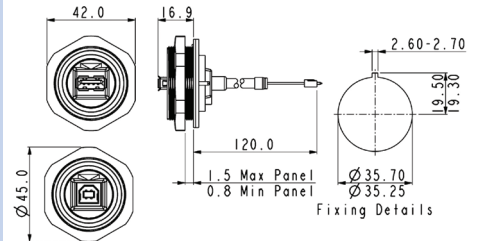

Part no. **Description**

PX0849/A	IP68 A type USB 2.0, rear panel mounted. Sealed A type at front of panel, 5-way header at rear
PX0849/B	IP68 B type USB 2.0, rear panel mounted. Sealed B type at front of panel, 5-way header at rear
PX0849/A3	IP68 A type USB 3.0, rear panel mounted. Sealed A type at front of panel, 10-way header at rear

PCB Panel Mounting Connector- PCB Direct Mount



PX0845/B

PX0845/A

- PX0845/A – USB 2.0 'A' type IP68 connector
- PX0845/B – USB 2.0 'B' type IP68 connector
- PX0845/A3 – USB 3.0 'A' type IP68 connector
- PCB contacts at rear
- Direct PCB mount
- Mates with PX0840 and PX0841 cable connectors

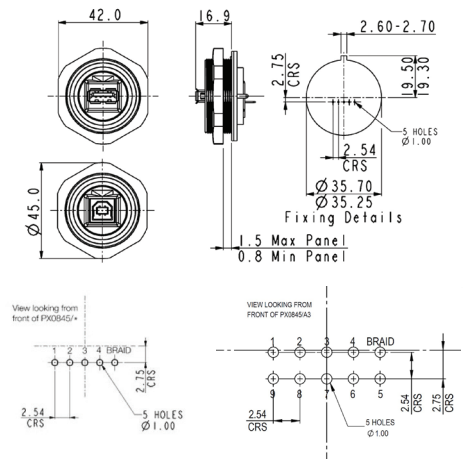

Part no. **Description**

PX0845/A	IP68 A type USB 2.0, rear panel mounted. Sealed A type at front of panel, direct mount PCB contacts at rear
PX0845/B	IP68 A type USB 2.0, rear panel mounted. Sealed A type at front of panel, direct mount PCB contacts at rear
PX0845/A3	IP68 A type USB 3.0, rear panel mounted. Sealed A type at front of panel, direct mount PCB contacts at rear

PCB Adaptor Leads

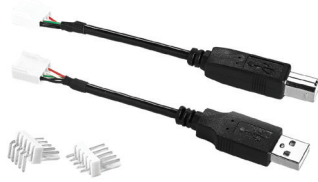

- Standard A and B type USB 2.0 connectors to 5-way crimp adaptor leads
- 5 way-headers, 2.54mm pitch, horizontal or vertical mounting
- Standard A type USB 3.0 to 10-way crimp adaptor leads

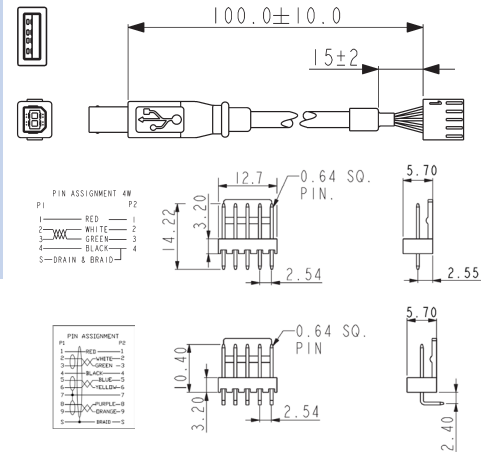

Part no.	Description
14193	USB 2.0 'A' type to 5-way crimp connector
14194	USB 2.0 'B' type to 5-way crimp connector
100286	USB 3.0 'A' type to 10-way crimp connector
14191	5-way PCB header straight
14192	5-way PCB header right angle
100287	10-way PCB header straight
100288	10-way PCB header right angle

Accessories



- Sealing caps to maintain IP68 rating when connectors are not in use
- PX0835 for cable connectors PX0840 & PX0841
- PX0733 for front panel mount connectors PX0842, PX0843 & PX0844
- PX0711 for rear panel mount connectors PX0848, PX0849 & PX0845

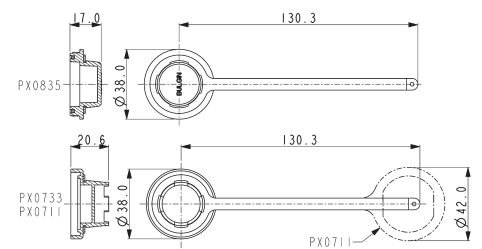

Part no.	Description
PX0835	Sealing Cap for cable connectors (PX0840, PX0841)
PX0733	Sealing Cap for front panel mounting connector (PX0842, PX0843 & PX0844)
PX0711	Sealing Cap for rear panel mounting connector (PX0848, PX0849, PX0845)

USB Flash Drive Cover



PX0852

- For use with USB Flash Drives
- Maintains IP68 rating when mated with panel connector
- For use with 'A' type connectors: PX0842, PX0843, PX0845, PX0848 & PX0849
- Internal accommodation 17.5 x 14.0 x 83mm approx.

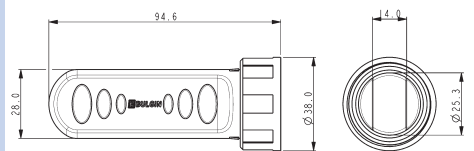

Screening Can



PX0465

- Maintains cable screening directly to panel
- Screening can clips around the panel fixing nut
- For use on PX0460/A, PX0460/B and PX0360/A3

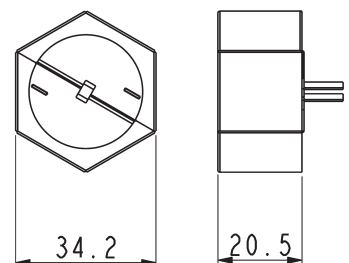

Cables & connectors

Mechanical	
Sealing	IP68, EN60529:1992+A2:2013 (10m depth for 2 weeks)
	IP69K, Tested in accordance with DIN 40050/Part 9 IP6k9k
Operating temperature	0°C to +70°C
Salt Mist	EN60068-2-52 Test Kb Salt Mist (Cyclic) Marine Severity Level 1
Electrical	
No. of Contacts	4
Current rating	1A
Voltage rating	30V AC (RMS)
Contact resistance	30m Ω max.
Performance	USB version 2.0

Materials - Overmoulded

Overmould material	PVC (black)
Flammability rating	UL94V-0

Materials - Re-wireable and Panel Connectors

Shell material	Steel
Shell plating	Nickel
Contact material	Copper Alloy
Contact plating	30 micro inch Gold
Connector body & locking ring	Glass Loaded Polyester
Panel connector	Acetal
Flammability rating	UL94 HB
'O' rings	Silicone
Panel Gasket - round	Silicone
Panel Gasket - square	Neoprene
Mating cycles	1,000
RoHS	Compliant

Materials - cable

Cable Jacket	PVC (black)
Screen	Tinned copper braid
Flammability	UL94V-0
RoHS	Compliant

Length:		Conductors	Conductors	
		Signal	Power	
	2m	4.8mm	2 x 28AWG	2 x 24AWG
	3m	5.0mm	2 x 28AWG	2 x 22AWG
5m	5.2mm	2 x 25AWG	2 x 20AWG	

PCB adaptor leads

Electrical	
No. of conductors	4
Current rating	1A
Voltage rating	30V AC (RMS)
Contact resistance	<10m Ω max.
PCB pitch	2.54mm
Materials	
Moulding	Polycarbonate
Flammability	UL94V-0
Contact material	Copper Alloy
Contact plating	30 micro inch Gold
Wire insulation	PVC (black)
Conductors	4 x 28AWG
Operating temperature	0°C to +70°C
Mating cycles	1,000
RoHS	Compliant

USB 2.0 Cable construction - PX0840, PX0841

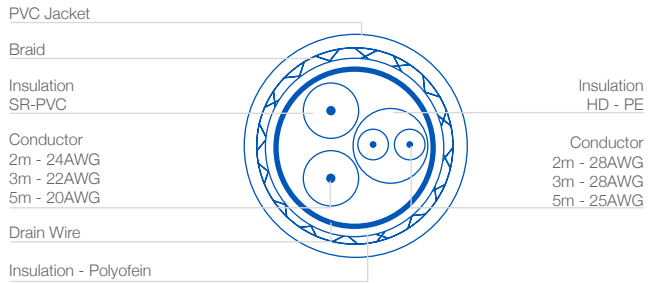

USB 2.0 Contact Diagram - PX0843 & PX0849

P1	TYPE	WIRE COLOUR	P2
+5V 1	—	RED	1 +5V
USB- 2 USB+ 3	⊗	WHITE / BLUE	2 USB- 3 USB+
GND 4	—	BLACK	4 GND
5	—	DRAIN & BRAID	5

Cables & connectors

Mechanical	
Sealing	IP68, EN60529:1992+A2:2013 (10m depth for 2 weeks)
	IP69K, Tested in accordance with DIN 40050/Part 9 IP6k9k
Operating temperature	0°C to +70°C
Salt Mist	EN60068-2-52 Test Kb Salt Mist (Cyclic) Marine Severity Level 1

Electrical	
No. of Contacts	9
Current rating	1A
Voltage rating	30V AC (RMS)
Contact resistance	30m Ω max.
Performance	USB version 3.0

Materials - Overmoulded	
Overmould material	PVC (black)
Flammability rating	UL94V-0

Materials - Re-wireable and Panel Connectors	
Shell material	Steel
Shell plating	Nickel
Contact material	Copper Alloy
Contact plating	Gold
Connector body & locking ring	Glass Loaded Polyester
Panel connector	Acetal
Flammability rating	UL94 HB
'O' rings	Silicone
Panel Gasket - round	Silicone
Panel Gasket - square	Neoprene
Mating cycles	1,000
RoHS	Compliant

Materials - cable	
Cable Jacket	PVC (black)
Screen	Tinned copper braid
Flammability	UL94V-0
RoHS	Compliant

Length:		Conductors	Conductors
		Signal	Power
1m	5.5mm	7 x 28AWG	2 x 24AWG
2m	5.5mm	7 x 28AWG	2 x 24AWG
3m	5.5mm	7 x 28AWG	2 x 24AWG

PCB adaptor leads

Electrical	
No. of conductors	9
Current rating	1A
Voltage rating	30V AC (RMS)
Contact resistance	30m Ω max.
PCB pitch	2.54mm

Materials	
Moulding	Polycarbonate
Flammability	UL94V-0
Contact material	Copper Alloy
Contact plating	Gold
Wire insulation	PVC (black)
Flammability	UL94-V0
Conductors	9 x 28AWG
Operating temperature	0°C to +70°C
Mating cycles	1,000
RoHS	Compliant

USB 3.0 Cable construction - PX0840/A3, PX0841/A3

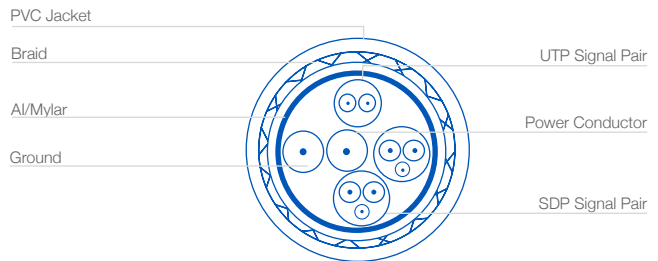

USB 3.0 Contact Diagram - PX0843/A3 & PX0849/A3

P1	TYPE	WIRE COLOUR	P2
+5V 1	—	RED	1 +5V
USB- 2	⊗	WHITE / GREEN	2 USB-
USB+ 3	⊗		3 USB+
GND 4	—	BLACK	4 GND
SSTX- 5	⊗	BLUE / YELLOW	5 SSTX-
SSTX+ 6			6 SSTX+
GND 7	—	N/A	7 GND
SSRX- 8	⊗	PURPLE / ORANGE	8 SSRX-
SSRX+ 9			9 SSRX+
S	—	BRAID	S