

NPN EPITAXIAL SILICON TRANSISTOR HIGH FREQUENCY LOW DISTORTION AMPLIFIER

FEATURES

- **HIGH COLLECTOR CURRENT:**
100 mA MAX
- **NEW HIGH GAIN POWER MINI-MOLD PACKAGE**
(SOT-89 TYPE)
- **HIGH OUTPUT POWER AT 1 dB COMPRESSION:**
22 dBm TYP at 1 GHz
- **HIGH IP₃:**
32 dBm TYP at 1 GHz

DESCRIPTION

The NE856M02 is an NPN silicon epitaxial bipolar transistor designed for medium power applications requiring high dynamic range and low intermodulation distortion. This device offers excellent performance and reliability at low cost through the titanium, platinum, gold metallization system and direct nitride passivation of the surface of the chip. The NE856M02 is an excellent choice for low noise amplifiers in the VHF to UHF band and is suitable for CATV and other telecommunication applications.

OUTLINE DIMENSIONS (Units in mm)

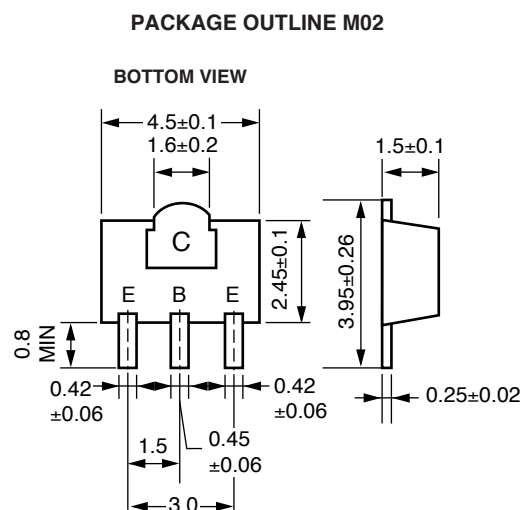

PIN CONNECTIONS

E: Emitter
C: Collector
B: Base

ELECTRICAL CHARACTERISTICS (T_A = 25°C)

PART NUMBER EIAJ ¹ REGISTERED NUMBER PACKAGE OUTLINE			NE856M02 2SC5336 M02		
SYMBOLS	PARAMETERS AND CONDITIONS	UNITS	MIN	TYP	MAX
I _{CBO}	Collector Cutoff Current at V _{CB} = 10 V, I _E = 0	μA			1.0
I _{EBO}	Emitter Cutoff Current at V _{EB} = 1 V, I _C = 0	μA			1.0
h _{FE} ²	DC Current Gain at V _{CE} = 10 V, I _C = 20 mA		50	120	250
f _T	Gain Bandwidth Product at V _{CE} = 10 V, I _C = 20 mA	GHz		6.5	
C _{RE} ³	Feed-back Capacitance at V _{CB} = 10 V, I _E = 0, f = 1.0 MHz	pF		0.5	0.8
IS _{21E} ²	Insertion Power Gain at V _{CE} = 10 V, I _C = 20 mA, f = 1 GHz	dB		12.0	
NF ₁	Noise Figure 1 at V _{CE} = 10 V, I _C = 7 mA, f = 1 GHz	dB		1.1	
NF ₂	Noise Figure 2 at V _{CE} = 10 V, I _C = 40 mA, f = 1 GHz	dB		1.8	3.0

Notes:

1. Electronic Industrial Association of Japan.
2. Pulsed measurement, pulse width ≤ 350 μs, duty cycle ≤ 2 %.
3. The emitter terminal should be connected to the ground terminal of the 3 terminal capacitance bridge.

ABSOLUTE MAXIMUM RATINGS¹ (T_A = 25°C)

SYMBOLS	PARAMETERS	UNITS	RATINGS
V _{CB0}	Collector to Base Voltage	V	20
V _{CE0}	Collector to Emitter Voltage	V	12
V _{EB0}	Emitter to Base Voltage	V	3.0
I _C	Collector Current	mA	100
P _T	Total Power Dissipation ²	W	1.2
T _J	Junction Temperature	°C	150
T _{STG}	Storage Temperature	°C	-65 to +150

Notes:

1. Operation in excess of any one of these parameters may result in permanent damage.
2. Device mounted on 0.7 mm X 16 cm² double-sided ceramic substrate (copper plating).

TYPICAL PERFORMANCE CURVES (T_A = 25°C)

TOTAL POWER DISSIPATION vs. AMBIENT TEMPERATURE

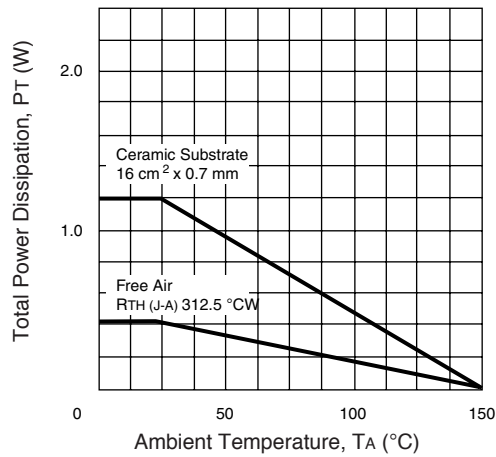

FEED BACK CAPACITANCE vs. COLLECTOR TO BASE VOLTAGE

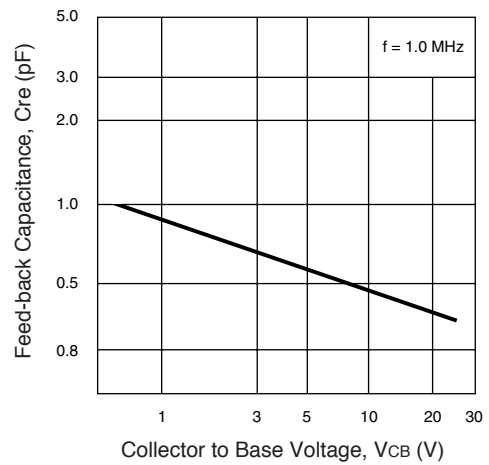

DC CURRENT GAIN vs. COLLECTOR CURRENT

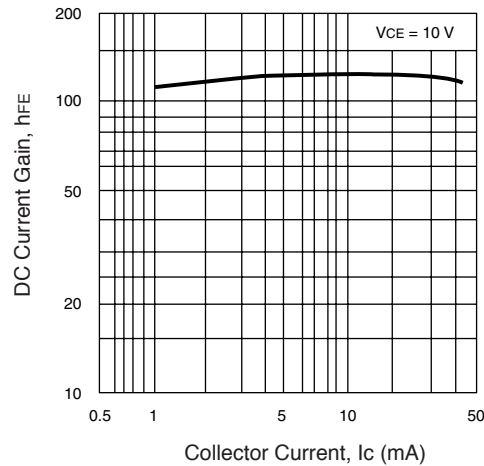

INSERTION GAIN vs. COLLECTOR CURRENT

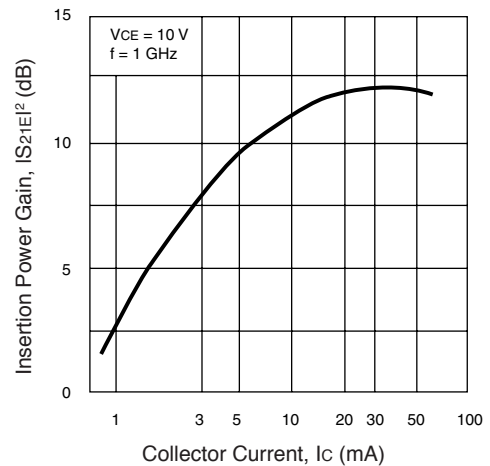

TYPICAL PERFORMANCE CURVES (TA = 25°C)

GAIN BAND WIDTH PRODUCT vs. COLLECTOR CURRENT

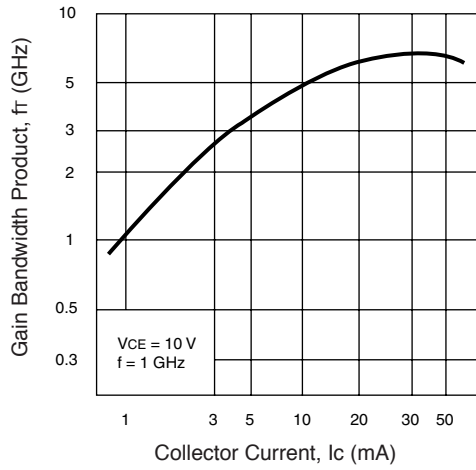

INSERTION GAIN AND MAXIMUM GAIN vs. FREQUENCY

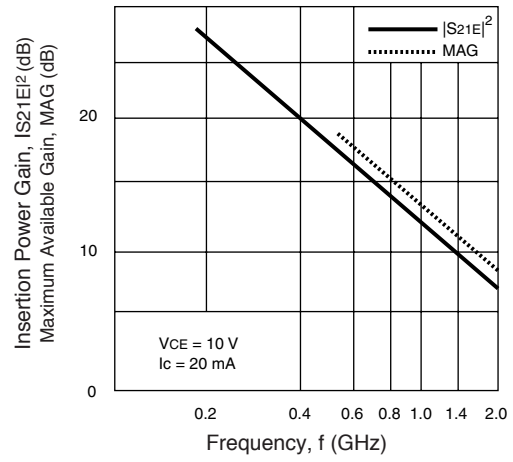

NOISE FIGURE vs. COLLECTOR CURRENT

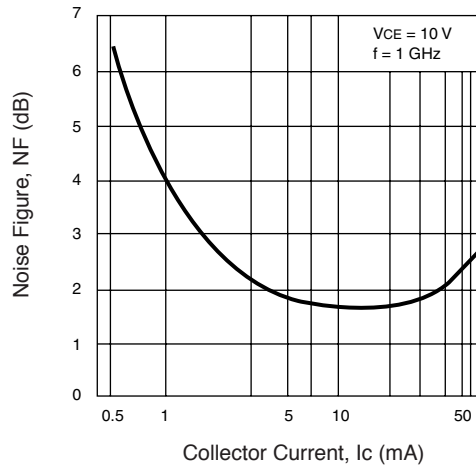

INTERMODULATION DISTORTION vs. COLLECTOR CURRENT

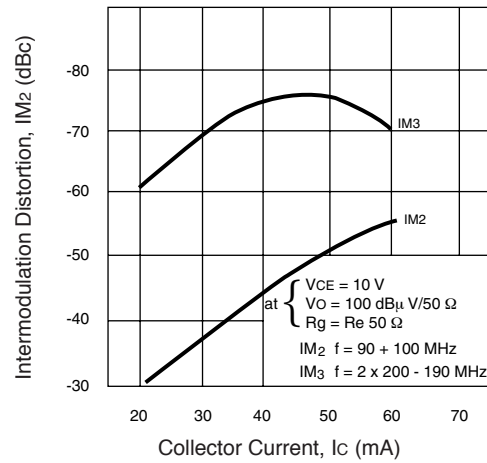

TYPICAL COMMON EMITTER SCATTERING PARAMETERS (TA = 25°C)

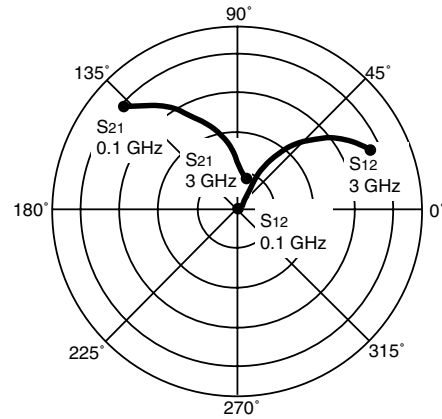
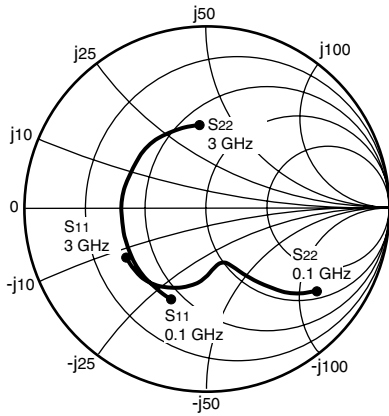

Coordinates in Ohms
Frequency in GHz
VCE = 3 V, IC = 10 mA

NE856M02

VCE = 3 V, IC = 10 mA

FREQUENCY (GHz)	S11		S21		S12		S22		K	MAG (dB)
	MAG	ANG	MAG	ANG	MAG	ANG	MAG	ANG		
0.100	0.626	-67.5	20.474	137.7	0.031	60.2	0.766	-36.6	0.26	28.2
0.200	0.535	-110.6	14.152	115.2	0.044	50.4	0.541	-52.5	0.47	25.1
0.400	0.479	-149.7	7.982	94.8	0.059	50.0	0.366	-63.4	0.77	21.3
0.600	0.465	-168.7	5.464	83.6	0.073	53.3	0.316	-68.4	0.94	18.7
0.800	0.461	178.6	4.146	75.2	0.089	55.6	0.306	-72.9	1.03	15.7
1.000	0.459	168.7	3.339	68.0	0.104	56.7	0.311	-77.1	1.08	13.3
1.200	0.458	160.4	2.800	61.5	0.121	56.9	0.323	-81.0	1.10	11.7
1.400	0.458	152.9	2.415	55.5	0.138	56.7	0.340	-84.8	1.11	10.5
1.600	0.457	146.0	2.127	49.9	0.155	55.8	0.358	-88.1	1.10	9.4
1.800	0.458	139.5	1.905	44.6	0.171	54.8	0.376	-91.4	1.10	8.6
2.000	0.457	133.2	1.728	39.5	0.188	53.5	0.394	-94.3	1.08	7.9
2.200	0.457	127.0	1.582	34.7	0.205	51.9	0.412	-97.1	1.07	7.2
2.400	0.458	121.2	1.464	30.2	0.222	50.2	0.428	-99.7	1.05	6.8
2.600	0.459	115.4	1.363	26.0	0.239	48.6	0.442	-102.2	1.04	6.3
2.800	0.460	109.7	1.278	21.9	0.256	46.6	0.455	-104.8	1.02	6.0
3.000	0.462	103.9	1.204	17.9	0.272	44.5	0.466	-107.4	1.01	5.7

Note:

1. Gain Calculation:

$$MAG = \frac{|S_{21}|}{|S_{12}|} (K \pm \sqrt{K^2 - 1}). \text{ When } K \leq 1, \text{ MAG is undefined and MSG values are used. } MSG = \frac{|S_{21}|}{|S_{12}|}, K = \frac{1 + |\Delta|^2 - |S_{11}|^2 - |S_{22}|^2}{2 |S_{12} S_{21}|}, \Delta = S_{11} S_{22} - S_{21} S_{12}$$

MAG = Maximum Available Gain

MSG = Maximum Stable Gain

TYPICAL COMMON EMITTER SCATTERING PARAMETERS (T_A = 25°C)

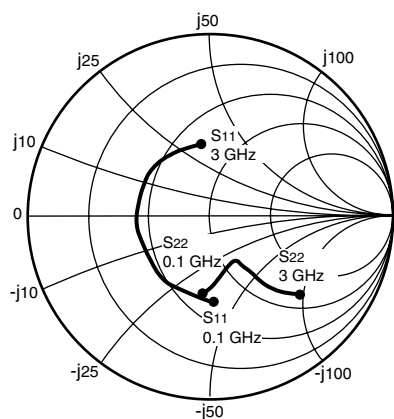

Coordinates in Ohms
Frequency in GHz
V_{CE} = 5 V, I_c = 20 mA

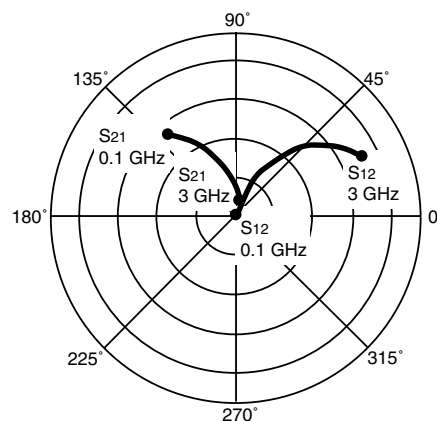

NE856M02

V_{CE} = 5 V, I_c = 20 mA

FREQUENCY (GHz)	S ₁₁		S ₂₁		S ₁₂		S ₂₂		K	MAG (dB)
	MAG	ANG	MAG	ANG	MAG	ANG	MAG	ANG		
0.100	0.481	-88.5	28.679	129.0	0.023	57.9	0.664	-41.3	0.42	31.0
0.200	0.434	-130.1	17.703	108.4	0.031	56.9	0.445	-52.9	0.68	27.5
0.400	0.414	-162.4	9.494	91.4	0.048	62.0	0.311	-58.6	0.92	22.9
0.600	0.411	-178.1	6.428	81.9	0.066	64.1	0.280	-62.1	1.02	19.1
0.800	0.410	171.0	4.855	74.4	0.084	65.0	0.280	-66.4	1.05	16.2
1.000	0.410	162.2	3.900	67.9	0.101	64.4	0.290	-70.7	1.07	14.2
1.200	0.409	154.5	3.265	61.9	0.120	63.2	0.305	-74.9	1.07	12.7
1.400	0.409	147.5	2.810	56.3	0.137	61.8	0.323	-79.0	1.07	11.4
1.600	0.408	140.9	2.471	51.0	0.154	60.0	0.343	-82.5	1.07	10.4
1.800	0.407	134.6	2.208	45.9	0.172	58.2	0.362	-85.9	1.06	9.6
2.000	0.406	128.6	2.000	41.1	0.188	56.2	0.381	-88.8	1.05	8.9
2.200	0.406	122.7	1.829	36.4	0.205	54.1	0.399	-91.7	1.04	8.3
2.400	0.406	117.0	1.689	32.0	0.222	52.0	0.416	-94.4	1.03	7.8
2.600	0.406	111.4	1.571	27.7	0.238	49.8	0.431	-96.9	1.02	7.4
2.800	0.408	105.9	1.471	23.7	0.253	47.6	0.445	-99.4	1.01	7.1
3.000	0.409	100.4	1.384	19.7	0.268	45.3	0.457	-101.9	1.00	7.1

Note:

1. Gain Calculation:

$$\text{MAG} = \frac{|S_{21}|}{|S_{12}|} \left(K \pm \sqrt{K^2 - 1} \right). \text{ When } K \leq 1, \text{ MAG is undefined and MSG values are used. } \text{MSG} = \frac{|S_{21}|}{|S_{12}|}, K = \frac{1 + |\Delta|^2 - |S_{11}|^2 - |S_{22}|^2}{2 |S_{12} S_{21}|}, \Delta = S_{11} S_{22} - S_{21} S_{12}$$

MAG = Maximum Available Gain

MSG = Maximum Stable Gain

TYPICAL COMMON EMITTER SCATTERING PARAMETERS (TA = 25°C)

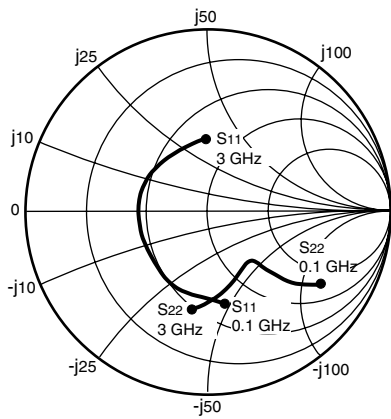

Coordinates in Ohms
Frequency in GHz
VCE = 10 V, IC = 20 mA

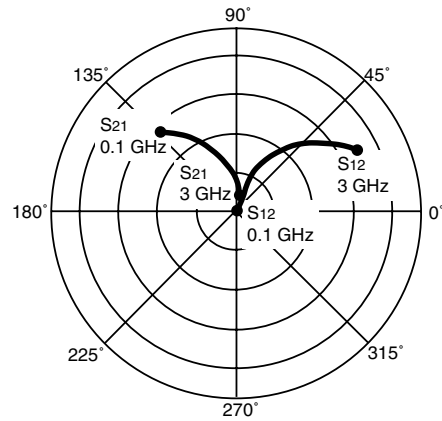

NE856M02

VCE = 10 V, IC = 20 mA

FREQUENCY (GHz)	S11		S21		S12		S22		K	MAG (dB)
	MAG	ANG	MAG	ANG	MAG	ANG	MAG	ANG		
0.100	0.508	-78.9	29.606	131.4	0.019	57.0	0.707	-34.0	0.43	32.0
0.200	0.425	-120.5	18.715	110.2	0.029	57.5	0.500	-42.7	0.65	28.1
0.400	0.384	-156.2	10.140	92.5	0.043	62.1	0.373	-45.9	0.91	23.7
0.600	0.376	-173.7	6.875	82.6	0.058	64.6	0.347	-48.9	1.01	20.0
0.800	0.374	174.4	5.192	75.0	0.074	65.4	0.346	-53.4	1.05	17.1
1.000	0.374	164.9	4.168	68.3	0.090	65.3	0.356	-58.2	1.07	15.0
1.200	0.375	156.8	3.481	62.2	0.106	64.5	0.370	-63.0	1.07	13.5
1.400	0.375	149.5	2.990	56.6	0.122	63.4	0.387	-67.7	1.07	12.3
1.600	0.375	142.7	2.620	51.2	0.137	61.9	0.406	-71.9	1.06	11.3
1.800	0.376	136.2	2.337	46.1	0.153	60.3	0.424	-75.9	1.05	10.4
2.000	0.377	130.1	2.109	41.2	0.168	58.6	0.443	-79.4	1.04	9.7
2.200	0.378	123.9	1.922	36.5	0.183	56.8	0.461	-82.9	1.03	9.2
2.400	0.380	118.2	1.770	32.1	0.198	54.8	0.478	-85.9	1.01	8.9
2.600	0.382	112.6	1.640	27.8	0.213	53.2	0.494	-88.8	0.99	8.9
2.800	0.385	107.0	1.531	23.7	0.227	51.1	0.508	-91.7	0.98	8.3
3.000	0.388	101.4	1.435	19.8	0.242	49.1	0.521	-94.5	0.97	7.7

Note:

1. Gain Calculation:

$$MAG = \frac{|S_{21}|}{|S_{12}|} (K \pm \sqrt{K^2 - 1})$$

When $K \leq 1$, MAG is undefined and MSG values are used. $MSG = \frac{|S_{21}|}{|S_{12}|}$, $K = \frac{1 + |\Delta|^2 - |S_{11}|^2 - |S_{22}|^2}{2 |S_{12} S_{21}|}$, $\Delta = S_{11} S_{22} - S_{21} S_{12}$

MAG = Maximum Available Gain

MSG = Maximum Stable Gain

TYPICAL COMMON EMITTER SCATTERING PARAMETERS (TA = 25°C)

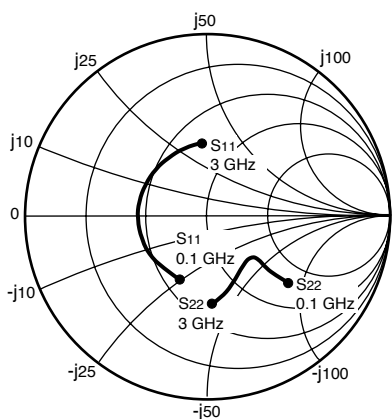

Coordinates in Ohms
Frequency in GHz
VCE = 10 V, IC = 50 mA

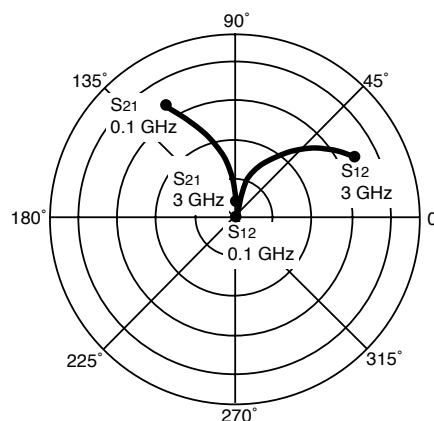

NE856M02

VCE = 10 V, IC = 50 mA

FREQUENCY (GHz)	S11		S21		S12		S22		K	MAG (dB)
	MAG	ANG	MAG	ANG	MAG	ANG	MAG	ANG		
0.100	0.388	-113.0	35.396	119.8	0.015	64.1	0.569	-38.2	0.60	33.7
0.200	0.380	-147.3	20.013	102.2	0.023	66.1	0.399	-40.5	0.85	29.4
0.400	0.377	-172.1	10.398	88.1	0.040	70.5	0.325	-41.0	1.00	23.7
0.600	0.378	175.4	6.989	79.6	0.057	71.3	0.316	-44.8	1.05	19.5
0.800	0.379	166.1	5.262	72.7	0.075	71.0	0.324	-50.2	1.06	16.9
1.000	0.380	158.2	4.218	66.5	0.092	69.4	0.337	-55.9	1.07	15.1
1.200	0.381	151.2	3.521	60.7	0.109	67.8	0.354	-61.1	1.06	13.6
1.400	0.382	144.7	3.023	55.3	0.125	65.9	0.373	-66.2	1.06	12.4
1.600	0.381	138.5	2.650	50.1	0.141	64.0	0.393	-70.7	1.05	11.4
1.800	0.382	132.5	2.362	45.1	0.157	62.0	0.412	-74.9	1.04	10.6
2.000	0.383	126.8	2.132	40.2	0.173	59.9	0.432	-78.6	1.03	9.9
2.200	0.383	121.0	1.943	35.6	0.188	57.7	0.451	-82.1	1.01	9.4
2.400	0.385	115.6	1.789	31.2	0.203	55.6	0.468	-85.3	1.00	9.5
2.600	0.386	110.2	1.657	27.0	0.218	53.6	0.485	-88.3	0.98	8.8
2.800	0.389	104.8	1.547	22.9	0.232	51.3	0.500	-91.2	0.97	8.2
3.000	0.392	99.5	1.450	19.0	0.246	49.3	0.513	-94.0	0.96	7.7

Note:

1. Gain Calculation:

$$MAG = \frac{|S_{21}|}{|S_{12}|} (K \pm \sqrt{K^2 - 1}). \text{ When } K \leq 1, \text{ MAG is undefined and MSG values are used. } MSG = \frac{|S_{21}|}{|S_{12}|}, K = \frac{1 + |\Delta|^2 - |S_{11}|^2 - |S_{22}|^2}{2 |S_{12}| |S_{21}|}, \Delta = S_{11} S_{22} - S_{21} S_{12}$$

MAG = Maximum Available Gain

MSG = Maximum Stable Gain

EXCLUSIVE NORTH AMERICAN AGENT FOR RF, MICROWAVE & OPTOELECTRONIC SEMICONDUCTORS

CEL CALIFORNIA EASTERN LABORATORIES • Headquarters • 4590 Patrick Henry Drive • Santa Clara, CA 95054-1817 • (408) 988-3500 • Telex 34-6393 • FAX (408) 988-0279
DATA SUBJECT TO CHANGE WITHOUT NOTICE

Internet: <http://WWW.CEL.COM>

11/14/2001

Mouser Electronics

Authorized Distributor

Click to View Pricing, Inventory, Delivery & Lifecycle Information:

[CEL:](#)

[NE85633-R24-A](#) [NE856M02-T1-AZ](#) [NE856M02-AZ](#)