







12 A / 250 V AC

- Miniature dimensions
- Cadmium - free contacts
- AC and DC coils
- For plug-in sockets, 35 mm DIN rail mount, EN 50022 or on panel mounting
- For PCB and soldering connections - option
- General purpose relays
- WT (mechanical indicator + lockable front test button) - standard features of relays for plug-in sockets. Relays may be provided with the test buttons type P (no latching) and plugs.

• Recognitions, certificates, directives: RoHS,    

Contacts

Contact number & arrangement	2C/O	
Contact material	AgNi , AgNi/Au 0.2 um, AgNi/Au 5 um	
Max. switching voltage	AC/DC	250 V / 250 V
Min. switching voltage	5 V	
Rated load	AC1	12 A / 250 V AC ① 10 A / 250 V AC ②
	DC1	12 A / 24 V DC ① 10 A / 24 V DC ②
Min. switching current	5 mA AgNi, 5 mA AgNi/Au 0.2 um, 2 mA AgNi/Au 5 um	
Max. inrush current	24 A	
Rated current	12 A ① 10 A ②	
Max. breaking capacity	AC1	3 000 VA ① 2 500 VA ②
Min. breaking capacity	0.3 W AgNi, 0.3 W AgNi/Au 0.2 um, 0.1 W AgNi/Au 5 um	
Resistance	≤ 100 mΩ	
Max. operating frequency	AC1	1 200 cycles/hour 18 000 cycles/hour
• at rated load • no load		

Coil

Rated voltage	50/60 Hz AC	6...240 V
	DC	5...220 V
Must release voltage	AC: ≥ 0.2 U _n DC: ≥ 0.1 U _n	
Operating range of supply voltage	see Tables 1, 2	
Rated power consumption	AC	1,6 VA
	DC	0,9 W

Insulation

Insulation category	C250	
Insulation rated voltage	250 V AC	
Rated surge voltage	4 000 V AC	
Overvoltage category	III IEC 61810-5 (PN-IEC 664-1)	
Insulation pollution degree	3	
Dielectric strength		
• coil - contact	2 500 V AC	
• contact - contact	1 500 V AC	
• pole - pole	2 500 V AC	
Contact - coil distance		
• clearance	≥ 2.5 mm	
• creepage	≥ 4 mm	

General data

Operating time (typical value)	AC: 10 ms	DC: 13 ms
Release time (typical value)	AC: 8 ms	DC: 3 ms
Electrical life		
• resistive AC1	≥ 10 ⁵ 12 A, 250 V AC	
• cos φ	see Fig. 2	
Mechanical life (cycles)	≥ 2 x 10 ⁷	
Dimensions (L x W x H)	27.5 x 21.2 x 35.6 mm ① 27.5 x 21.1 x 33.5 mm ② 27.5 x 21.2 x 33 mm ③	
Weight	35 g	
Ambient temperature		
• storage	-40...+85 °C	
• operating	AC: -40...+55 °C DC: -40...+70 °C	
Cover protection category	IP 40	
Environmental protection	RTI IEC 61810-7	
Shock resistance	(NO/NC)	10 g / 5 g
Vibration resistance	5 g 10...150 Hz	
Solder bath temperature	max. 270 °C	
Soldering time	max. 5 s	

Standard contact materials are marked with bold type.

① For plug-in sockets version: standard (WT) ② For PCB version ③ For version with threaded bolt

Coil data - DC voltage version

Table 1

Coil code	Rated voltage V DC	Coil resistance (±10%) at 20 °C Ω	Coil operating range V DC	
			min. (at 20 °C)	max. (at 55 °C)
1005	5	28	4.0	5.5
1006	6	40	4.8	6.6
1012	12	160	9.6	13.2
1024	24	640	19.2	26.4
1048	48	2 600	38.4	52.8
1060	60	4 000	48.0	66.0
1080	80	7 100	64.0	88.0
1110	110	13 600	88.0	121.0
1125	125	16 000	100.0	137.5
1220	220	54 000	176.0	242.0

Standard coil rated voltages marked with bold type.

Coil data - AC 50/60 Hz voltage version

Table 2

Coil code	Rated voltage V AC	Coil resistance (±10%) at 20 °C Ω	Coil operating range V AC	
			min. (at 20 °C)	max. (at 55 °C)
5006	6	9.8	4.8	6.6
5012	12	39.5	9.6	13.2
5024	24	158.0	19.2	26.4
5042	42	470.0	33.6	46.2
5048	48	640.0	38.4	52.8
5060	60	930.0	48.0	66.0
5080	80	1 720.0	64.0	88.0
5110	110	3 450.0	88.0	121.0
5120	120	3 770.0	96.0	132.0
5127	127	4 000.0	101.6	139.0
5220	220	15 400.0	176.0	242.0
5230	230	16 100.0	184.0	253.0
5240	240	16 800.0	192.0	264.0

Standard coil rated voltages marked with bold type.

Dimensions - plug-in version (WT), with lockable front test button type T

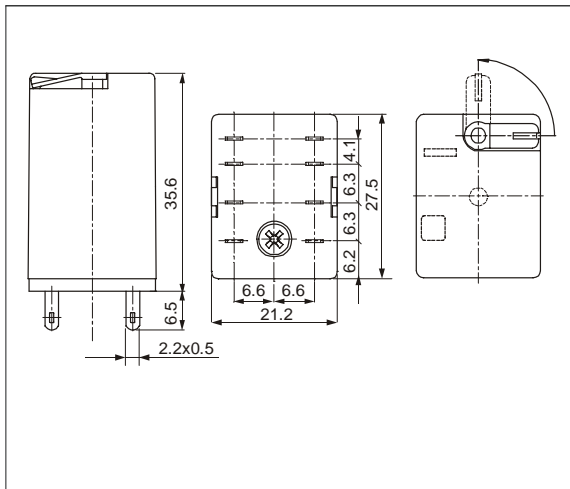

Dimensions - plug-in version (WT), with test button type P (no latching) or with plug (no manual operation)

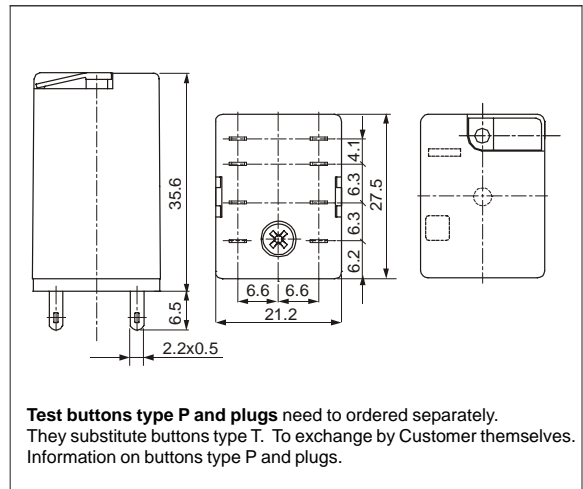

Test buttons type P and plugs need to be ordered separately. They substitute buttons type T. To be exchanged by the Customer themselves. Information on buttons type P and plugs.

Dimensions - PCB version (without WT)

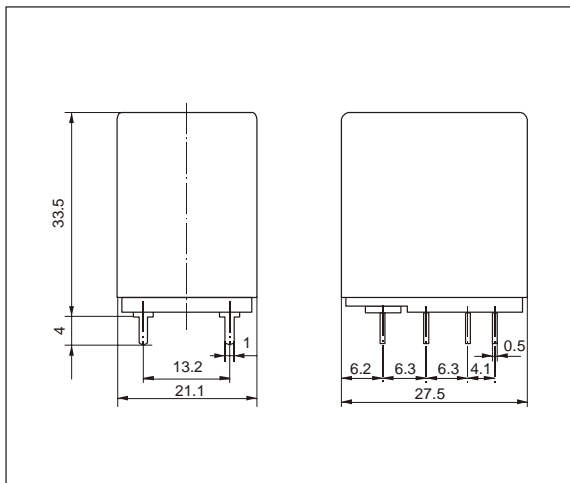

Dimensions - version with threaded bolt

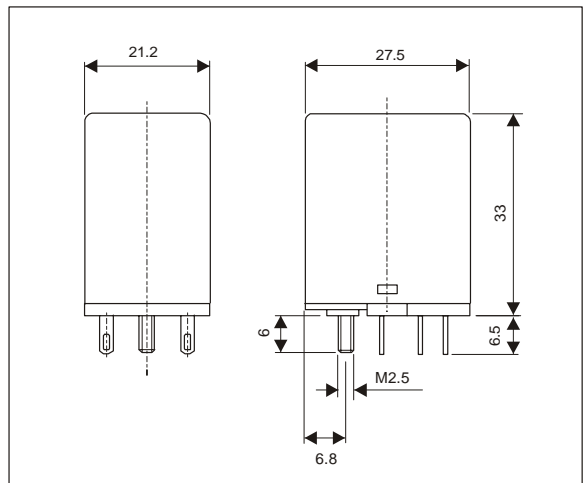

Dimensions - version with mounting flange in the upper wall of the cover (without WT)

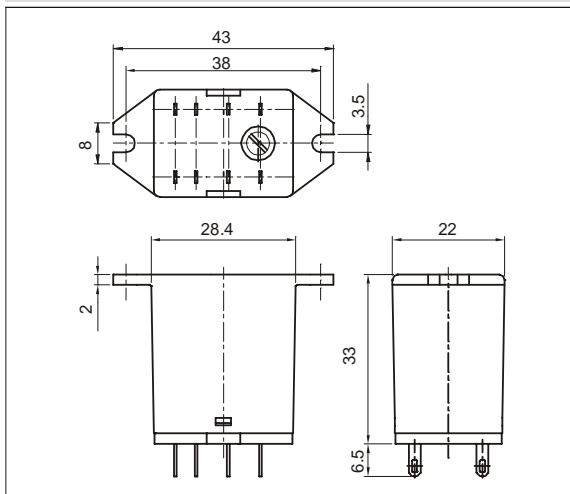

Connections diagram (pin side view)

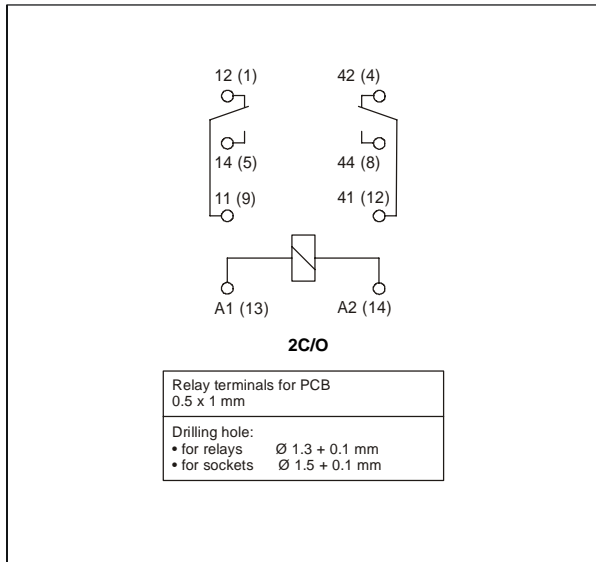

Electrical life at AC resistive load

Fig. 1

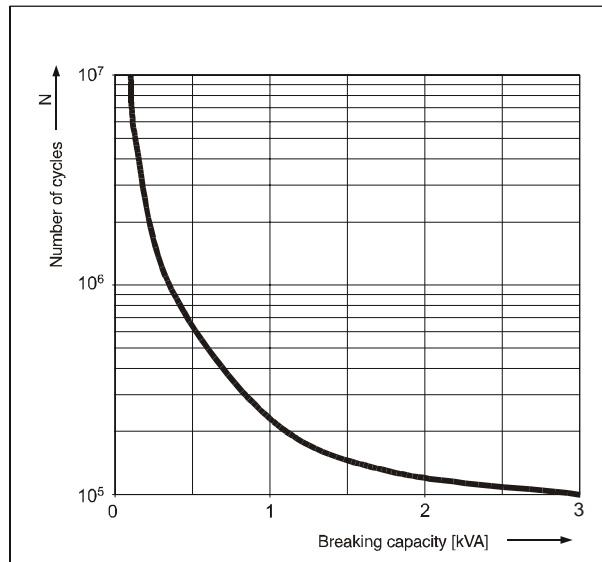

Electrical life reduction factor at AC inductive load

Fig. 2

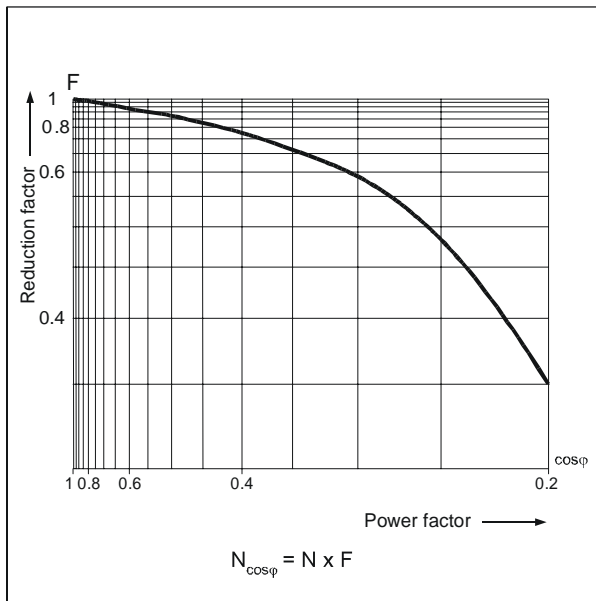

Max. DC resistive load breaking capacity

Fig. 3

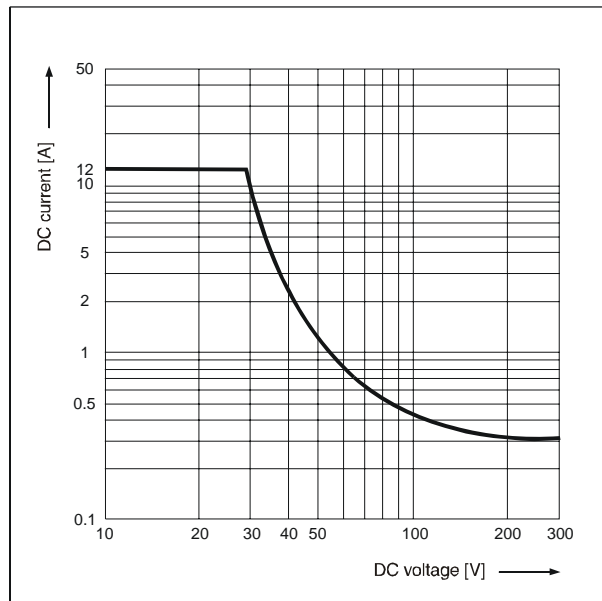

Mounting

Relays D2 are offered in versions:

- standard WT (mechanical indicator + lockable front test button), for plug-in sockets. In standard version of relays (WT) is possibility self-exchange of button type T for: button type P (no latching) or plug (no manual operation). Buttons type P and plugs need to ordered separately
- for PCB (without WT)
- with threaded bolt
- with mounting flange in the upper wall of the cover (without WT).

Relays D2 are designed for:

- screw terminals plug-in sockets DZT2 and DZM2 with clip DZT4-0040 or D4 1052; plug-in sockets DZR2 with clip D4 1052, 35 mm DIN rail mount, EN 50022 or on panel mounting. Signalling / protecting modules type DM... are available with sockets DZT2 and DZM2 (see page 240)
- plug-in sockets for PCB mounting DU4/2D with clip D4 1053 (WT) or D4 1050 (without WT)
- solder terminals sockets DU4/2L with clip D4 1053 (WT) or D4 1050 (without WT) and spring clamp D4 1040
- solder terminals sockets D4/2 with clip D4 1053 (WT) or D4 1050 (without WT)
- direct PCB mounting.

Contact material selection for different load types

- **AgNi** - for resistive or inductive loads,
- **AgNi/Au 0.2 um** - contact surface protection against oxidation during storage,
- **AgNi/Au 5 um** - for small resistive loads in control circuits.

Ordering codes

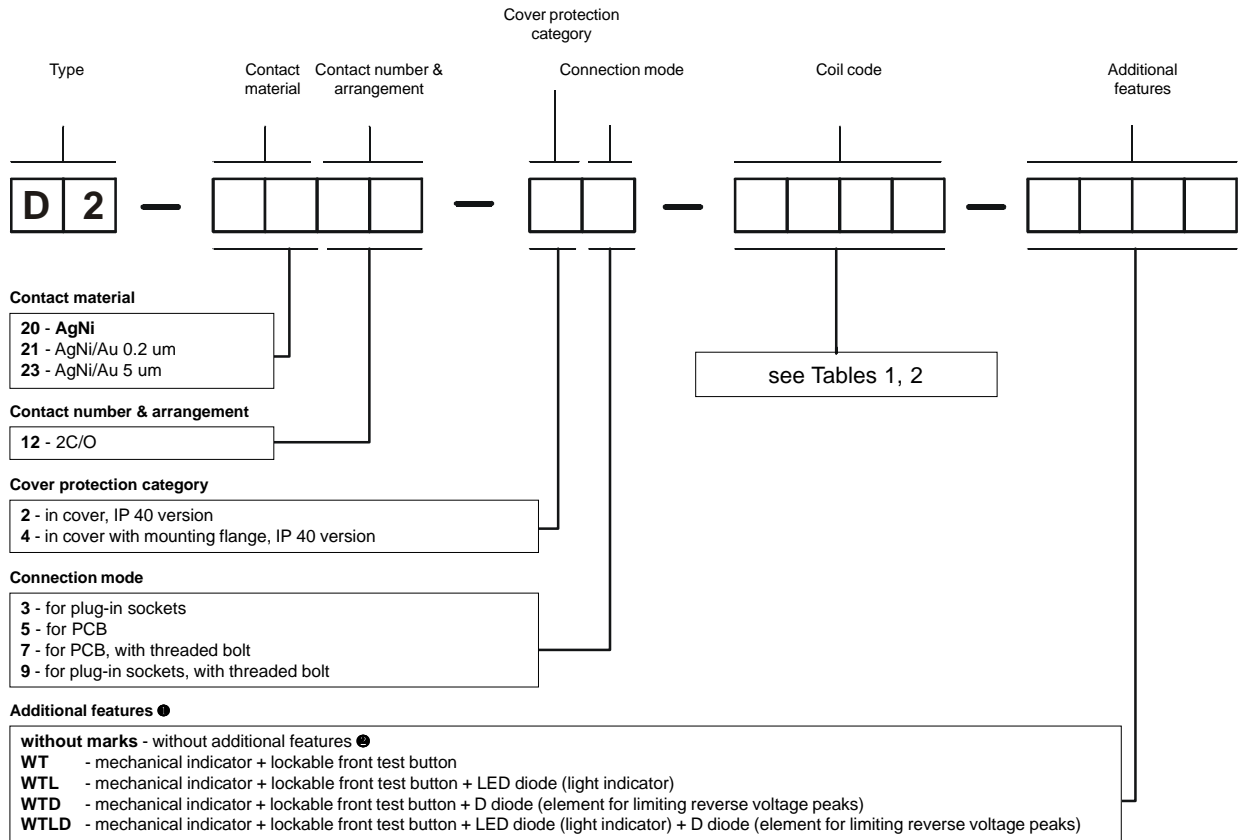

- ① **WT** - standard features of relays for plug-in sockets. **WTD, WTLD** - only for DC coils
- ② Refer relays for PCB; with threaded bolt; with mounting flange in the upper wall of the cover

Test buttons type P and plugs need to ordered separately. They substitute buttons type T. To exchange by Customer themselves.

Information on buttons type P and plugs .

- Button R4P-0001-A - orange colour (AC coils)
- Button R4P-0001-D - green colour (DC coils)
- Plug R4W-0003-A - orange colour (AC coils)
- Plug R4W-0003-D - green colour (DC coils)

Note:

For relays with DC coils and additional features inclusive: **D** - D diode (element for limiting reverse voltage peaks) and **L** - LED diode (light indicator) coil supply polarity is fixed. Terminal A1 (13) "+"; terminal A2 (14) "-". Supply polarity is marked on relay cover. Colour of lockable front test button type T represents type of coil supply current: orange - AC coil, green - DC coil.

Examples of ordering codes:

- D2-2012-23-1024-WT** relay **D2**, contact material AgNi, with two changeover contacts, in cover IP 40, for plug-in sockets, voltage version 24 V DC, with mechanical indicator and lockable front test button
- D2-2012-25-1024** relay **D2**, contact material AgNi, with two changeover contacts, in cover IP 40, for PCB, voltage version 24 V DC