

EMK22G2J-34.368M TR

Lead Free  COMPLIANT	EU RoHS 2011/65 + 2015/863 COMPLIANT	ChinaRoHS  COMPLIANT	REACH SVHC 163 Jun 15, 2015 COMPLIANT
--------------------------------------------------------------------------------------------------------------------------	-------------------------------------------------------------	---------------------------------------------------------------------------------------------------------------------------	---------------------------------------------------------------------



ITEM DESCRIPTION

MEMS Clock Oscillators LVCMOS (CMOS) 2.5Vdc 4 Pad 3.2mm x 5.0mm Plastic Surface Mount (SMD) 34.368MHz \pm 100ppm over -40°C to +85°C

ELECTRICAL SPECIFICATIONS

Nominal Frequency	34.368MHz
Frequency Tolerance/Stability	\pm 100ppm Maximum over -40°C to +85°C (Inclusive of all conditions: Calibration Tolerance at 25°C, Frequency Stability over the Operating Temperature Range, Supply Voltage Change, Output Load Change, First Year Aging at 25°C, 260°C Reflow, Shock, and Vibration)
Aging at 25°C	\pm 1ppm Maximum First Year
Supply Voltage	2.5Vdc \pm 5%
Input Current	20mA Maximum
Output Voltage Logic High (Voh)	90% of Vdd Minimum (IOH=-8mA)
Output Voltage Logic Low (Vol)	10% of Vdd Maximum (IOL=+8mA)
Rise/Fall Time	2nSec Maximum (Measured from 20% to 80% of waveform)
Duty Cycle	50 \pm 5(%) (Measured at 50% of waveform)
Load Drive Capability	15pF Maximum
Output Logic Type	CMOS
Output Control Function	Power Down (Disabled Output: Logic Low)
Output Control Input Voltage	+0.7Vdd Minimum or No Connect to Enable Output, +0.3Vdd Maximum to Disable Output
Standby Current	50 μ A Maximum (Disabled Output: Logic Low)
Peak to Peak Jitter (tPK)	250pSec Maximum, 100pSec Typical
Start Up Time	50mSec Maximum
Storage Temperature Range	-55°C to +125°C

ENVIRONMENTAL & MECHANICAL SPECIFICATIONS

ESD Susceptibility	MIL-STD-883, Method 3015, Class 2, HBM 2000V
Flammability	UL94-V0
Mechanical Shock	MIL-STD-883, Method 2002, Condition G, 30,000G
Moisture Resistance	MIL-STD-883, Method 1004
Moisture Sensitivity Level	J-STD-020, MSL 1
Resistance to Soldering Heat	MIL-STD-202, Method 210, Condition K
Resistance to Solvents	MIL-STD-202, Method 215
Solderability	MIL-STD-883, Method 2003 (Pads on bottom of package only)
Temperature Cycling	MIL-STD-883, Method 1010, Condition B
Thermal Shock	MIL-STD-883, Method 1011, Condition B
Vibration	MIL-STD-883, Method 2007, Condition A, 20G

EMK22G2J-34.368M TR

MECHANICAL DIMENSIONS (all dimensions in millimeters)

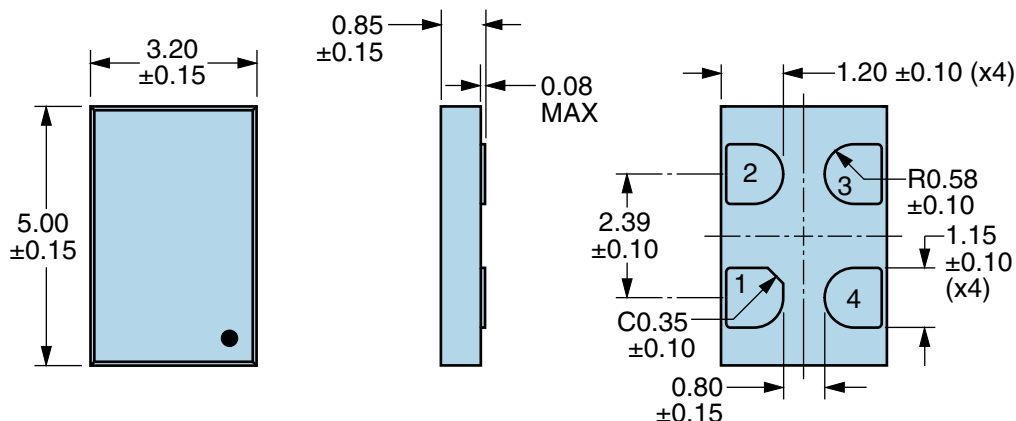

PIN	CONNECTION
1	Power Down
2	Ground
3	Output
4	Supply Voltage

LINE	MARKING
1	XXXX or XXXXX XXXX or XXXXX=Ecliptek Manufacturing Lot Code

Suggested Solder Pad Layout

All Dimensions in Millimeters

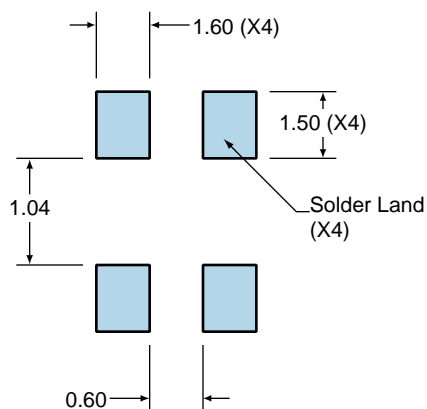

All Tolerances are ± 0.1

EMK22G2J-34.368M TR [↗](#)

OUTPUT WAVEFORM & TIMING DIAGRAM

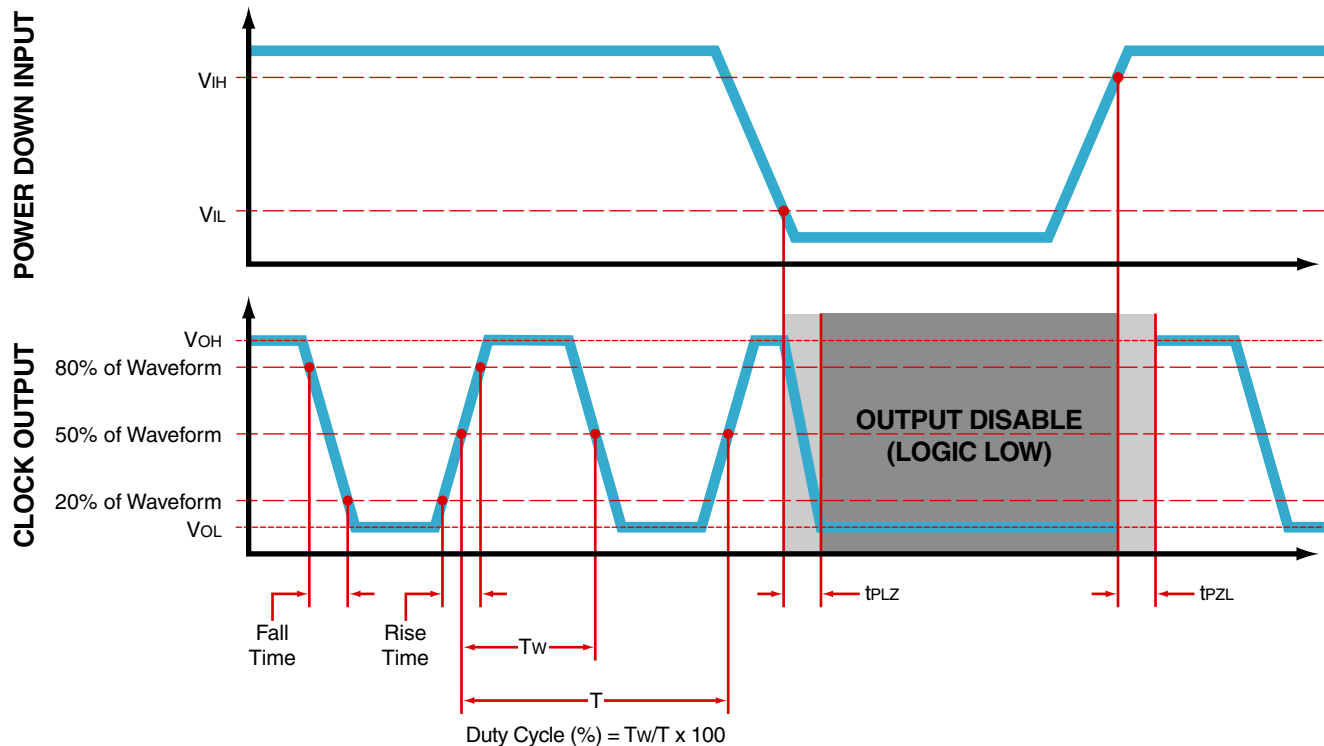

EMK22G2J-34.368M TR [↗](#)

Test Circuit for CMOS Output

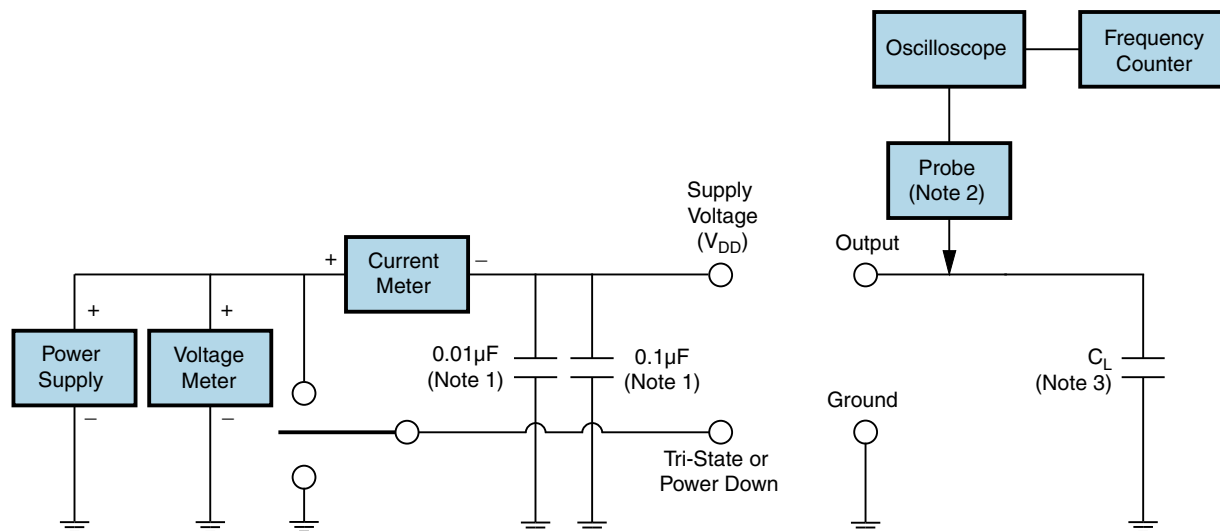

Note 1: An external $0.01\mu\text{F}$ ceramic bypass capacitor in parallel with a $0.1\mu\text{F}$ high frequency ceramic bypass capacitor close (less than 2mm) to the package ground and supply voltage pin is required.

Note 2: A low input capacitance ($<12\text{pF}$), 10X Attenuation Factor, High Impedance ($>10\text{Mohms}$), and High bandwidth ($>300\text{MHz}$) passive probe is recommended.

Note 3: Capacitance value C_L includes sum of all probe and fixture capacitance. See applicable specification sheet for 'Load Drive Capability'.

EMK22G2J-34.368M TR

Tape & Reel Dimensions

Quantity Per Reel: 1,000 units

All Dimensions in Millimeters

Compliant to EIA-481

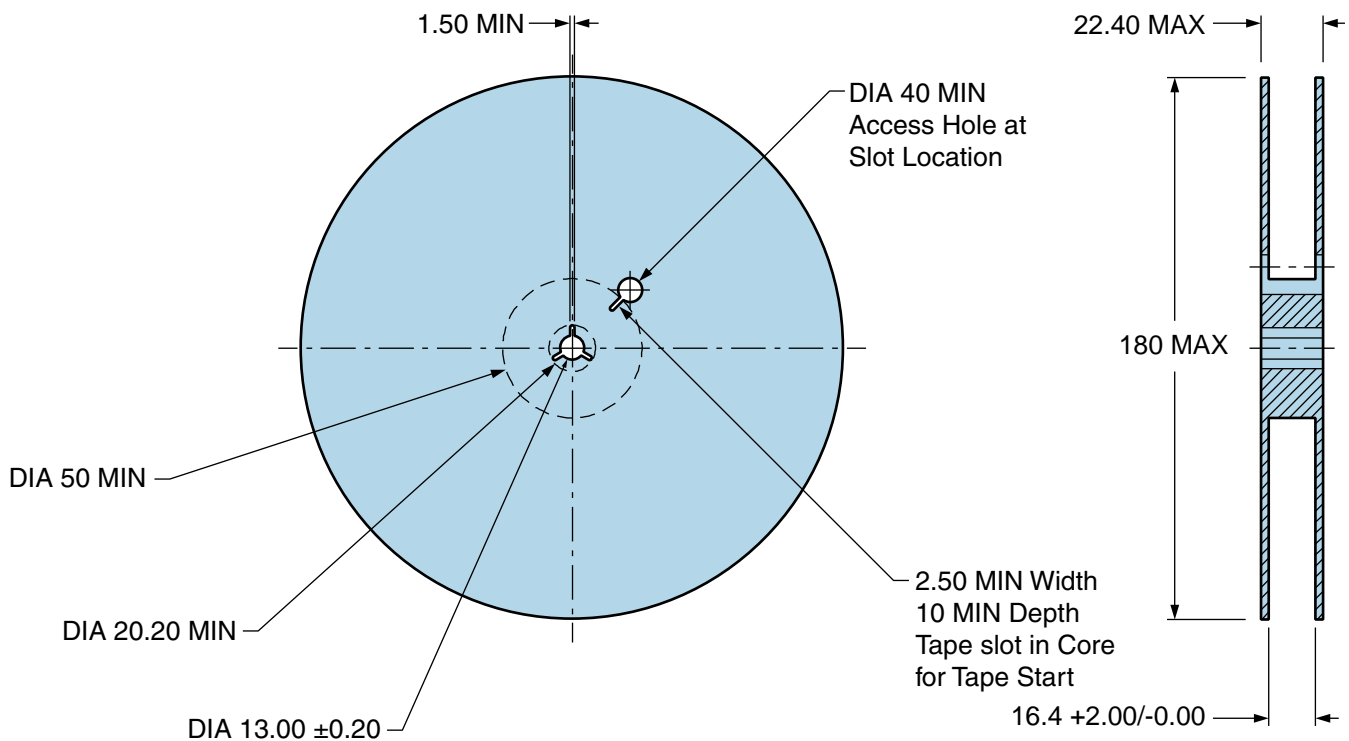

EMK22G2J-34.368M TR [↗](#)

Recommended Solder Reflow Methods

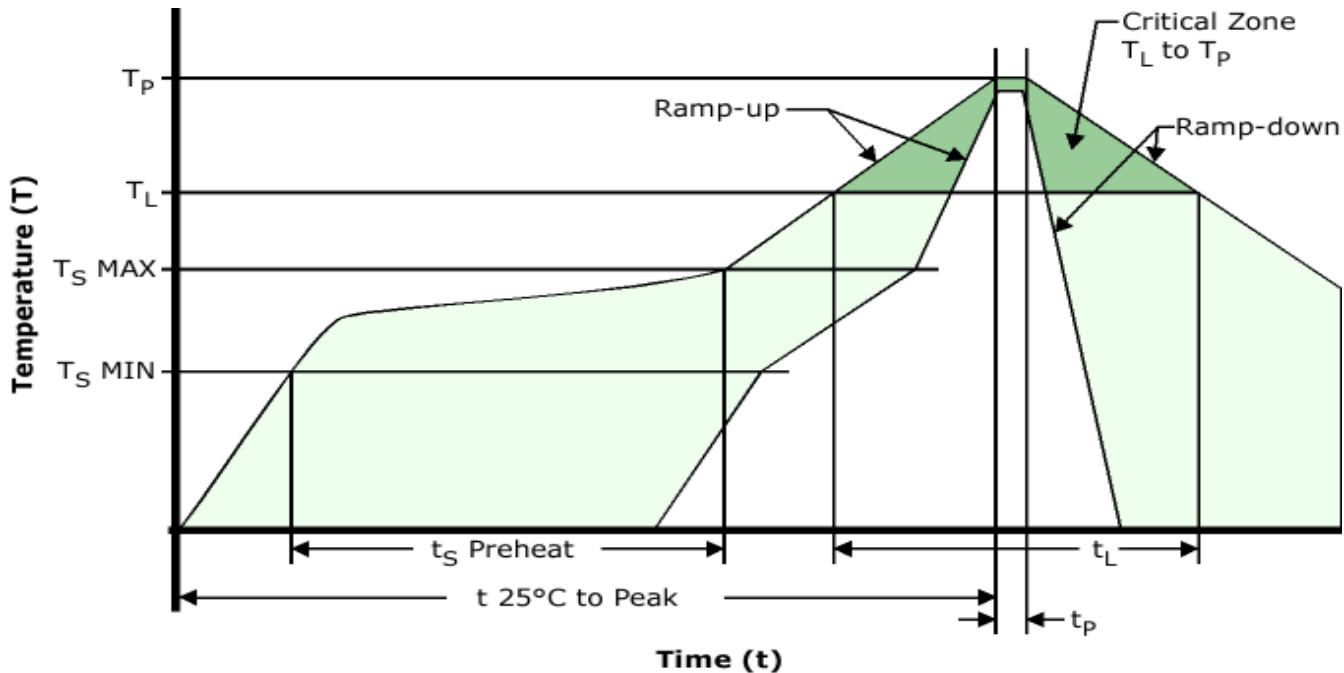

High Temperature Infrared/Convection

T_S MAX to T_L (Ramp-up Rate)	3°C/Second Maximum
Preheat	
- Temperature Minimum (T_S MIN)	150°C
- Temperature Typical (T_S TYP)	175°C
- Temperature Maximum (T_S MAX)	200°C
- Time (t_s MIN)	60 - 180 Seconds
Ramp-up Rate (T_L to T_P)	3°C/Second Maximum
Time Maintained Above:	
- Temperature (T_L)	217°C
- Time (t_L)	60 - 150 Seconds
Peak Temperature (T_P)	260°C Maximum for 10 Seconds Maximum
Target Peak Temperature (T_P Target)	250°C +0/-5°C
Time within 5°C of actual peak (t_p)	20 - 40 Seconds
Ramp-down Rate	6°C/Second Maximum
Time 25°C to Peak Temperature (t)	8 Minutes Maximum
Moisture Sensitivity Level	Level 1
Additional Notes	Temperatures shown are applied to body of device.

EMK22G2J-34.368M TR [↗](#)

Recommended Solder Reflow Methods

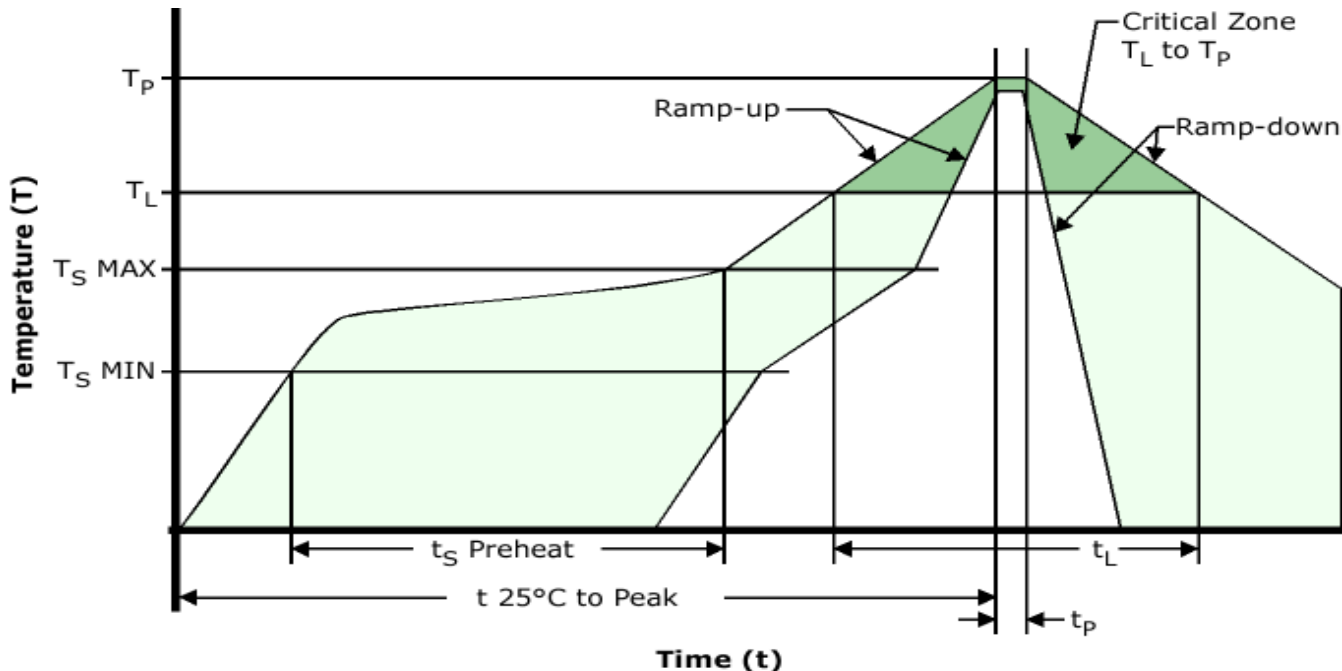

Low Temperature Infrared/Convection 240°C

Ts MAX to TL (Ramp-up Rate) 5°C/Second Maximum

Preheat

- Temperature Minimum (Ts MIN) N/A
 - Temperature Typical (Ts TYP) 150°C
 - Temperature Maximum (Ts MAX) N/A
 - Time (ts MIN) 60 - 120 Seconds

Ramp-up Rate (TL to TP) 5°C/Second Maximum

Time Maintained Above:

- Temperature (TL) 150°C
 - Time (tL) 200 Seconds Maximum

Peak Temperature (TP) 240°C Maximum

Target Peak Temperature (TP Target) 240°C Maximum 2 Times / 230°C Maximum 1 Time

Time within 5°C of actual peak (tp) 10 Seconds Maximum 2 Times / 80 Seconds Maximum 1 Time

Ramp-down Rate 5°C/Second Maximum

Time 25°C to Peak Temperature (t) N/A

Moisture Sensitivity Level Level 1

Additional Notes Temperatures shown are applied to body of device.

Low Temperature Manual Soldering

185°C Maximum for 10 Seconds Maximum, 2 times Maximum. (Temperatures shown are applied to body of device.)

High Temperature Manual Soldering

260°C Maximum for 5 Seconds Maximum, 2 times Maximum. (Temperatures shown are applied to body of device.)