

Cascadable Silicon Bipolar MMIC Amplifier

Technical Data

MSA-1104

Features

- **High Dynamic Range**
Cascadable 50 Ω or 75 Ω
Gain Block
- **3 dB Bandwidth:**
50 MHz to 1.3 GHz
- **17.5 dBm Typical $P_{1\text{ dB}}$ at
0.5 GHz**
- **12 dB Typical 50 Ω Gain at
0.5 GHz**
- **3.6 dB Typical Noise Figure
at 0.5 GHz**
- **Low Cost Plastic Package**

Description

The MSA-1104 is a high performance silicon bipolar Monolithic Microwave Integrated Circuit (MMIC) housed in a low cost

plastic package. This MMIC is designed for high dynamic range in either 50 or 75 Ω systems by combining low noise figure with high IP_3 . Typical applications include narrow and broadband linear amplifiers in commercial and industrial systems.

The MSA-series is fabricated using HP's 10 GHz f_T , 25 GHz f_{MAX} silicon bipolar MMIC process which uses nitride self-alignment, ion implantation, and gold metallization to achieve excellent performance, uniformity and reliability. The use of an external bias resistor for temperature and current stability also allows bias flexibility.

04A Plastic Package

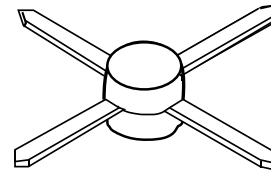

Typical Biasing Configuration

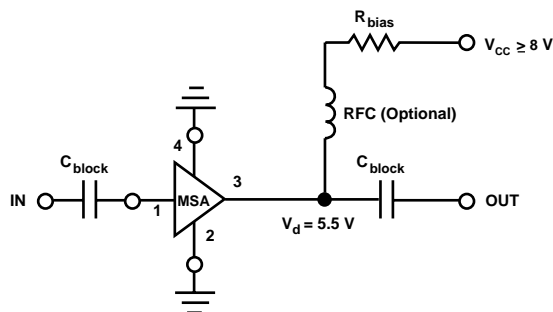

MSA-1104 Absolute Maximum Ratings

Parameter	Absolute Maximum ^[1]
Device Current	80 mA
Power Dissipation ^[2,3]	550 mW
RF Input Power	+1 dBm
Junction Temperature	150°C
Storage Temperature	-65 to 150°C

Thermal Resistance^{[2,4]:}

$$\theta_{jc} = 115^{\circ}\text{C/W}$$

Notes:

1. Permanent damage may occur if any of these limits are exceeded.
2. $T_{\text{CASE}} = 25^{\circ}\text{C}$.
3. Derate at $8.7 \text{ mW/}^{\circ}\text{C}$ for $T_{\text{C}} > 87^{\circ}\text{C}$.
4. See MEASUREMENTS section “Thermal Resistance” for more information.

Electrical Specifications^[1], $T_{\text{A}} = 25^{\circ}\text{C}$

Symbol	Parameters and Test Conditions: $I_{\text{d}} = 60 \text{ mA}$, $Z_{\text{o}} = 50 \Omega$	Units	Min.	Typ.	Max.
G _P	Power Gain ($ S_{21} ^2$)	f = 0.05 GHz			12.7
		f = 0.5 GHz	10.0		12.0
		f = 1.0 GHz			10.5
ΔG_{P}	Gain Flatness	f = 0.1 to 1.0 GHz		± 1.0	
f _{3 dB}	3 dB Bandwidth ^[2]	GHz		1.3	
VSWR	Input VSWR	f = 0.1 to 1.0 GHz		1.5:1	
	Output VSWR	f = 0.1 to 1.0 GHz		1.7:1	
NF	50 Ω Noise Figure	f = 0.5 GHz		3.6	
P _{1 dB}	Output Power at 1 dB Gain Compression	f = 0.5 GHz		17.5	
IP ₃	Third Order Intercept Point	f = 0.5 GHz		30	
t _D	Group Delay	f = 0.5 GHz		200	
V _d	Device Voltage	V	4.4	5.5	6.6
dV/dT	Device Voltage Temperature Coefficient	mV/°C		-8.0	

Notes:

1. The recommended operating current range for this device is 40 to 70 mA. Typical performance as a function of current is on the following page.
2. Referenced from 50 MHz gain (G_P).

MSA-1104 Typical Scattering Parameters ($Z_0 = 50 \Omega$, $T_A = 25^\circ\text{C}$, $I_d = 60 \text{ mA}$)

Freq. GHz	S_{11}		S_{21}			S_{12}			S_{22}		k
	Mag	Ang	dB	Mag	Ang	dB	Mag	Ang	Mag	Ang	
.0005	.76	-22	19.3	9.19	167	-24.4	.060	54	.77	-22	0.48
.005	.20	-79	13.7	4.83	164	-16.5	.149	12	.21	-83	0.96
.025	.05	-78	12.8	4.35	174	-16.2	.154	2	.06	-101	1.07
.050	.04	-75	12.7	4.31	174	-16.4	.151	2	.05	-136	1.09
.100	.04	-81	12.6	4.29	171	-16.4	.152	2	.05	-137	1.09
.200	.04	-93	12.6	4.24	164	-16.3	.153	3	.07	-135	1.09
.300	.06	-105	12.4	4.18	156	-16.2	.155	4	.10	-136	1.08
.400	.07	-115	12.3	4.11	148	-16.0	.158	5	.12	-139	1.07
.500	.09	-124	12.1	4.01	141	-15.8	.162	6	.15	-144	1.06
.600	.11	-132	11.8	3.91	134	-15.6	.166	7	.17	-150	1.06
.700	.13	-140	11.6	3.80	126	-15.4	.170	7	.19	-156	1.05
.800	.15	-147	11.3	3.68	120	-15.2	.174	7	.22	-161	1.04
.900	.16	-154	11.0	3.56	113	-14.9	.180	7	.24	-168	1.03
1.000	.18	-161	10.7	3.43	106	-14.7	.184	6	.26	-173	1.03
1.500	.28	171	9.1	2.85	77	-13.5	.211	2	.35	163	0.99
2.000	.37	149	7.6	2.39	52	-13.0	.224	-5	.43	140	0.99
2.500	.45	133	6.1	2.02	33	-12.7	.231	-10	.47	125	1.02
3.000	.52	118	4.6	1.69	14	-12.6	.234	-16	.50	112	1.05

A model for this device is available in the DEVICE MODELS section.

Typical Performance, $T_A = 25^\circ\text{C}$, $Z_0 = 50 \Omega$

(unless otherwise noted)

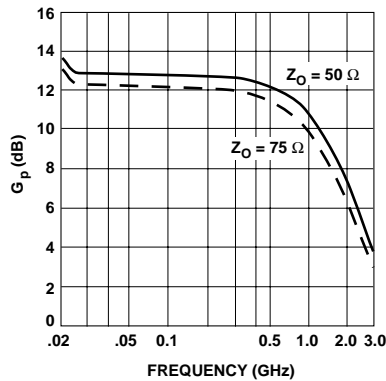

Figure 1. Typical Power Gain vs. Frequency, $I_d = 60 \text{ mA}$.

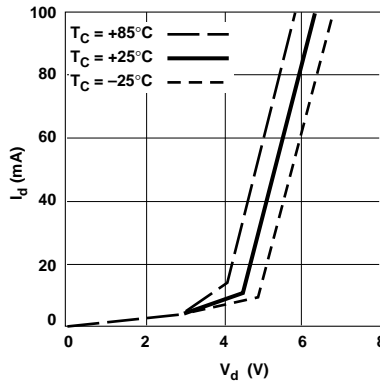

Figure 2. Device Current vs. Voltage.

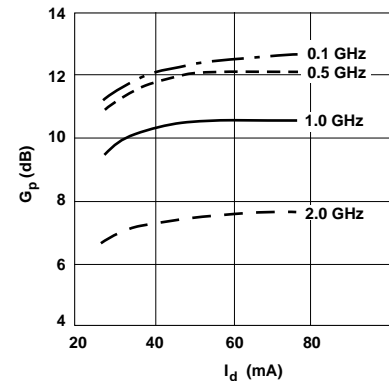

Figure 3. Power Gain vs. Current.

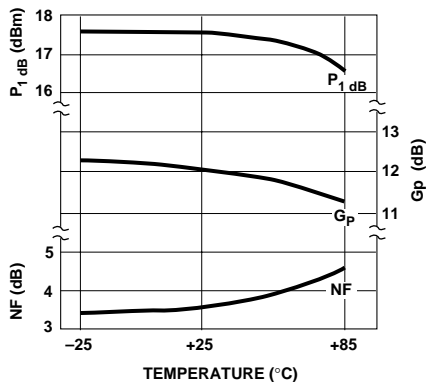

Figure 4. Output Power at 1 dB Gain Compression, Noise Figure and Power Gain vs. Case Temperature, $f = 0.5 \text{ GHz}$, $I_d = 60 \text{ mA}$.

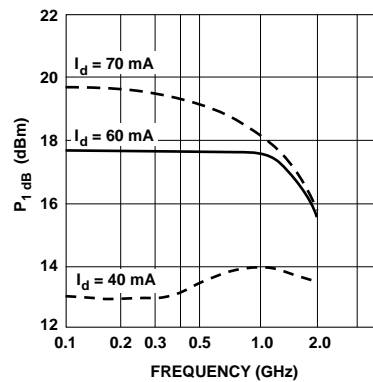

Figure 5. Output Power at 1 dB Gain Compression vs. Frequency.

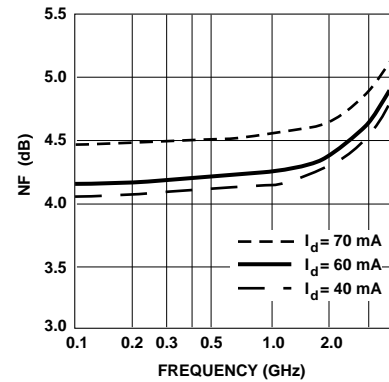

Figure 6. Noise Figure vs. Frequency.

04A Plastic Package Dimensions

