

**AUTOMOTIVE MOSFET**

**IRF2804S-7P**

HEXFET® Power MOSFET

**Features**

- Advanced Process Technology
- Ultra Low On-Resistance
- 175°C Operating Temperature
- Fast Switching
- Repetitive Avalanche Allowed up to Tjmax

**Description**

Specifically designed for Automotive applications, this HEXFET® Power MOSFET utilizes the latest processing techniques to achieve extremely low on-resistance per silicon area. Additional features of this design are a 175°C junction operating temperature, fast switching speed and improved repetitive avalanche rating. These features combine to make this design an extremely efficient and reliable device for use in Automotive applications and a wide variety of other applications.

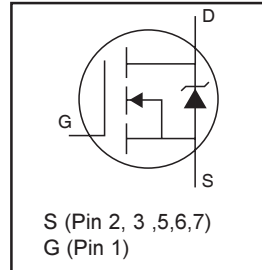

$V_{DSS} = 40V$
$R_{DS(on)} = 1.6m\Omega$
$I_D = 160A$

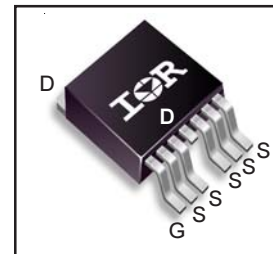

**Absolute Maximum Ratings**

	Parameter	Max.	Units
$I_D @ T_C = 25^\circ C$	Continuous Drain Current, $V_{GS} @ 10V$ (Silicon Limited)	320	A
$I_D @ T_C = 100^\circ C$	Continuous Drain Current, $V_{GS} @ 10V$ (See Fig. 9)	230	
$I_D @ T_C = 25^\circ C$	Continuous Drain Current, $V_{GS} @ 10V$ (Package Limited)	160	
$I_{DM}$	Pulsed Drain Current ①	1360	
$P_D @ T_C = 25^\circ C$	Maximum Power Dissipation	330	W
	Linear Derating Factor	2.2	W/°C
$V_{GS}$	Gate-to-Source Voltage	$\pm 20$	V
$E_{AS}$	Single Pulse Avalanche Energy (Thermally Limited) ②	630	mJ
$E_{AS} (tested)$	Single Pulse Avalanche Energy Tested Value ③	1050	
$I_{AR}$	Avalanche Current ①	See Fig.12a,12b,15,16	A
$E_{AR}$	Repetitive Avalanche Energy ⑤		mJ
$T_J$	Operating Junction and	-55 to + 175	°C
$T_{STG}$	Storage Temperature Range		
	Soldering Temperature, for 10 seconds	300 (1.6mm from case )	
	Mounting torque, 6-32 or M3 screw	10 lbf•in (1.1N•m)	

**Thermal Resistance**

	Parameter	Typ.	Max.	Units
$R_{\theta JC}$	Junction-to-Case ③	—	0.50	°C/W
$R_{\theta CS}$	Case-to-Sink, Flat, Greased Surface	0.50	—	
$R_{\theta JA}$	Junction-to-Ambient ④	—	62	
$R_{\theta JA}$	Junction-to-Ambient (PCB Mount, steady state) ⑦ ⑧	—	40	

HEXFET® is a registered trademark of International Rectifier.

www.irf.com

## Static @ $T_J = 25^\circ\text{C}$ (unless otherwise specified)

	Parameter	Min.	Typ.	Max.	Units	Conditions
$V_{(BR)DSS}$	Drain-to-Source Breakdown Voltage	40	—	—	V	$V_{GS} = 0V, I_D = 250\mu A$
$\Delta BV_{DSS}/\Delta T_J$	Breakdown Voltage Temp. Coefficient	—	0.028	—	V/ $^\circ\text{C}$	Reference to $25^\circ\text{C}, I_D = 1mA$
$R_{DS(on)SMD}$	Static Drain-to-Source On-Resistance	—	1.2	1.6	m $\Omega$	$V_{GS} = 10V, I_D = 160A$ ③
$V_{GS(th)}$	Gate Threshold Voltage	2.0	—	4.0	V	$V_{DS} = V_{GS}, I_D = 250\mu A$
gfs	Forward Transconductance	220	—	—	S	$V_{DS} = 10V, I_D = 160A$
$I_{DSS}$	Drain-to-Source Leakage Current	—	—	20	$\mu A$	$V_{DS} = 40V, V_{GS} = 0V$
		—	—	250		$V_{DS} = 40V, V_{GS} = 0V, T_J = 125^\circ\text{C}$
$I_{GSS}$	Gate-to-Source Forward Leakage	—	—	200	nA	$V_{GS} = 20V$
	Gate-to-Source Reverse Leakage	—	—	-200		$V_{GS} = -20V$
$Q_g$	Total Gate Charge	—	170	260	nC	$I_D = 160A$
$Q_{gs}$	Gate-to-Source Charge	—	63	—		$V_{DS} = 32V$
$Q_{gd}$	Gate-to-Drain ("Miller") Charge	—	71	—		$V_{GS} = 10V$ ③
$t_{d(on)}$	Turn-On Delay Time	—	17	—	ns	$V_{DD} = 20V$
$t_r$	Rise Time	—	150	—		$I_D = 160A$
$t_{d(off)}$	Turn-Off Delay Time	—	110	—		$R_G = 2.6\Omega$
$t_f$	Fall Time	—	105	—		$V_{GS} = 10V$ ②
$L_D$	Internal Drain Inductance	—	4.5	—	nH	Between lead, 6mm (0.25in.) from package and center of die contact
$L_S$	Internal Source Inductance	—	7.5	—		
$C_{iss}$	Input Capacitance	—	6930	—	pF	$V_{GS} = 0V$
$C_{oss}$	Output Capacitance	—	1750	—		$V_{DS} = 25V$
$C_{rss}$	Reverse Transfer Capacitance	—	970	—		$f = 1.0MHz$ , See Fig. 5
$C_{oss}$	Output Capacitance	—	5740	—		$V_{GS} = 0V, V_{DS} = 1.0V, f = 1.0MHz$
$C_{oss}$	Output Capacitance	—	1570	—		$V_{GS} = 0V, V_{DS} = 32V, f = 1.0MHz$
$C_{oss\ eff.}$	Effective Output Capacitance	—	2340	—		$V_{GS} = 0V, V_{DS} = 0V$ to 32V

## Diode Characteristics

	Parameter	Min.	Typ.	Max.	Units	Conditions
$I_S$	Continuous Source Current (Body Diode)	—	—	320	A	MOSFET symbol showing the integral reverse p-n junction diode.
$I_{SM}$	Pulsed Source Current (Body Diode) ①	—	—	1360		
$V_{SD}$	Diode Forward Voltage	—	—	1.3	V	$T_J = 25^\circ\text{C}, I_S = 160A, V_{GS} = 0V$ ③
$t_{rr}$	Reverse Recovery Time	—	43	65	ns	$T_J = 25^\circ\text{C}, I_F = 160A, V_{DD} = 20V$
$Q_{rr}$	Reverse Recovery Charge	—	48	72	nC	$di/dt = 100A/\mu s$ ③

### Notes:

- ① Repetitive rating; pulse width limited by max. junction temperature. (See fig. 11).
- ② Limited by  $T_{Jmax}$ , starting  $T_J = 25^\circ\text{C}$ ,  $L=0.049mH, R_G = 25\Omega, I_{AS} = 160A, V_{GS} = 10V$ . Part not recommended for use above this value.
- ③ Pulse width  $\leq 1.0ms$ ; duty cycle  $\leq 2\%$ .
- ④  $C_{oss\ eff.}$  is a fixed capacitance that gives the same charging time as  $C_{oss}$  while  $V_{DS}$  is rising from 0 to 80%  $V_{DSS}$ .
- ⑤ Limited by  $T_{Jmax}$ , see Fig.12a, 12b, 15, 16 for typical repetitive avalanche performance.
- ⑥ This value determined from sample failure population. 100% tested to this value in production.
- ⑦ This is applied to D<sup>2</sup>Pak, when mounted on 1" square PCB (FR-4 or G-10 Material). For recommended footprint and soldering techniques refer to application note #AN-994.
- ⑧  $R_{\theta}$  is measured at  $T_J$  of approximately  $90^\circ\text{C}$ .

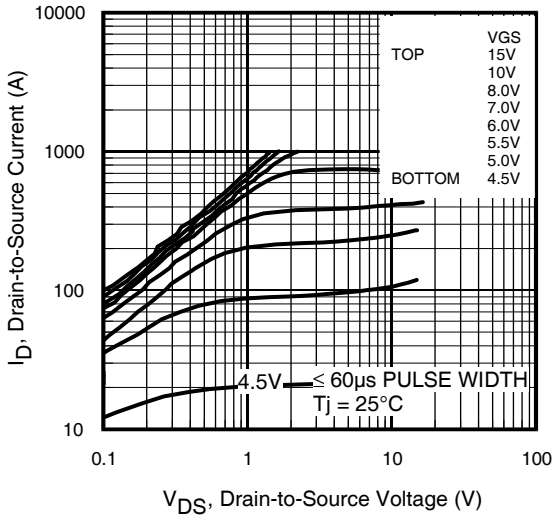

**Fig 1.** Typical Output Characteristics

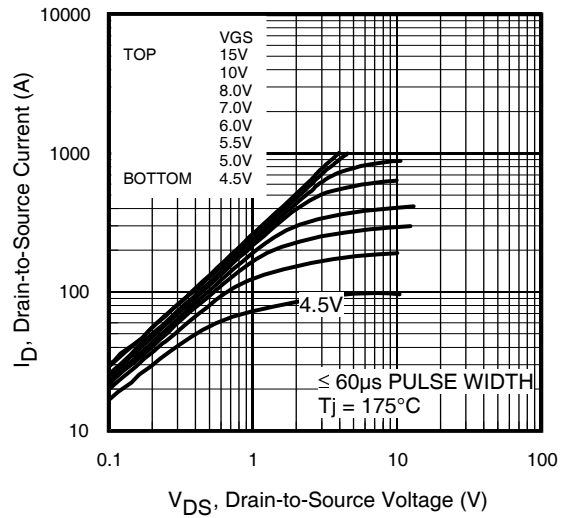

**Fig 2.** Typical Output Characteristics

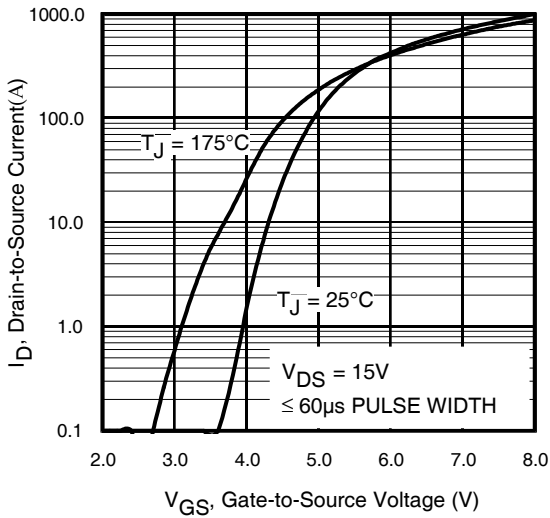

**Fig 3.** Typical Transfer Characteristics

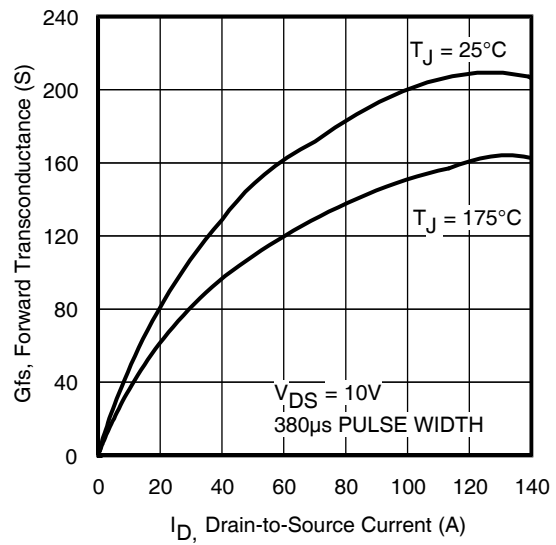

**Fig 4.** Typical Forward Transconductance vs. Drain Current

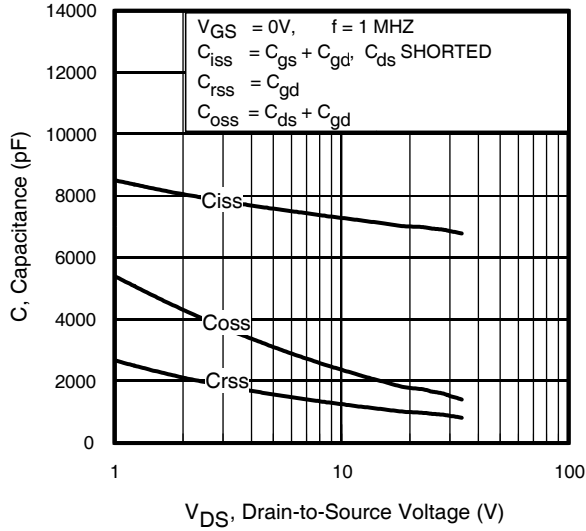

**Fig 5.** Typical Capacitance vs. Drain-to-Source Voltage

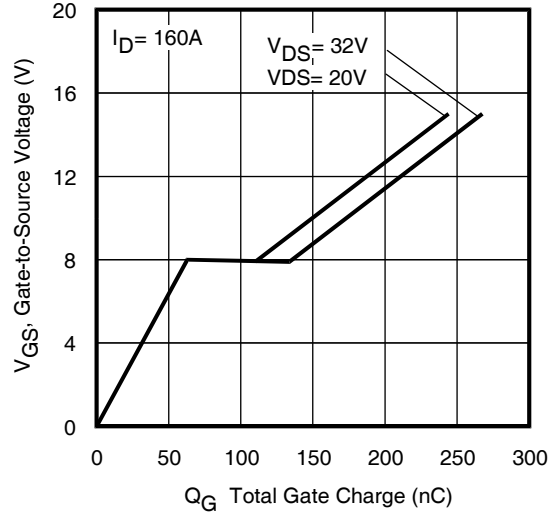

**Fig 6.** Typical Gate Charge vs. Gate-to-Source Voltage

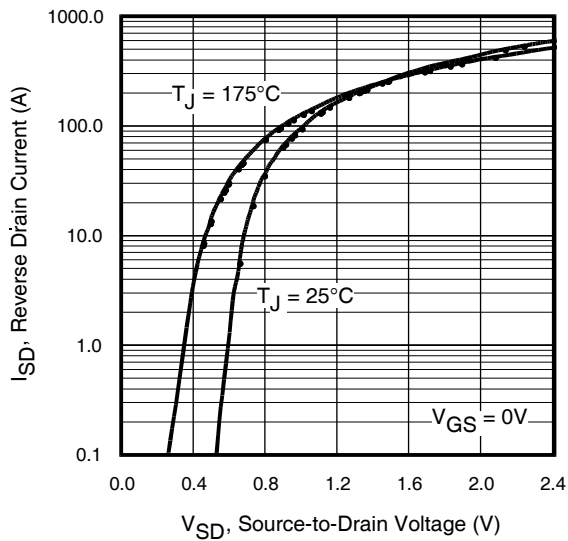

**Fig 7.** Typical Source-Drain Diode Forward Voltage

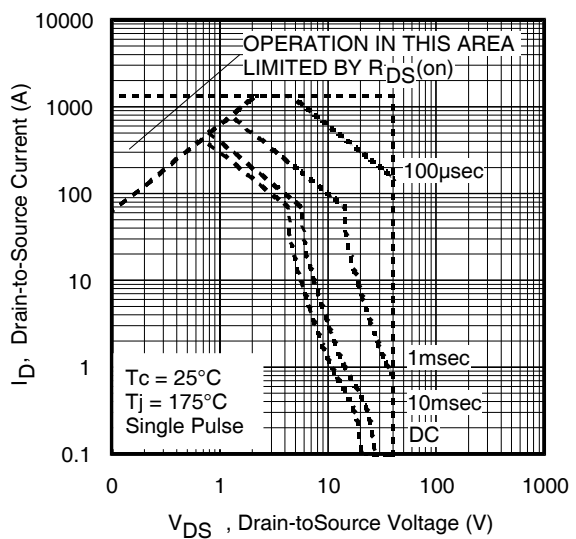

**Fig 8.** Maximum Safe Operating Area

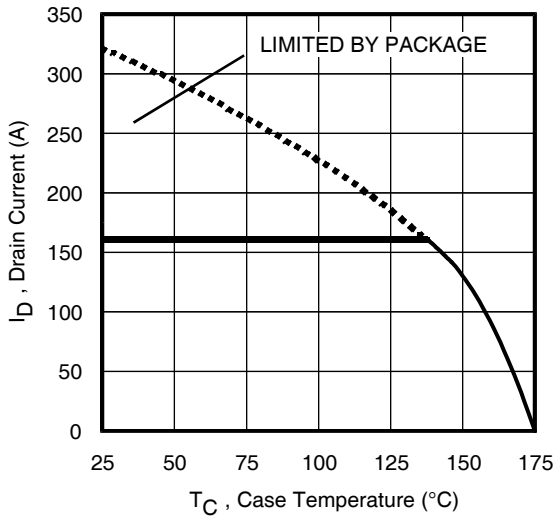

**Fig 9.** Maximum Drain Current vs. Case Temperature

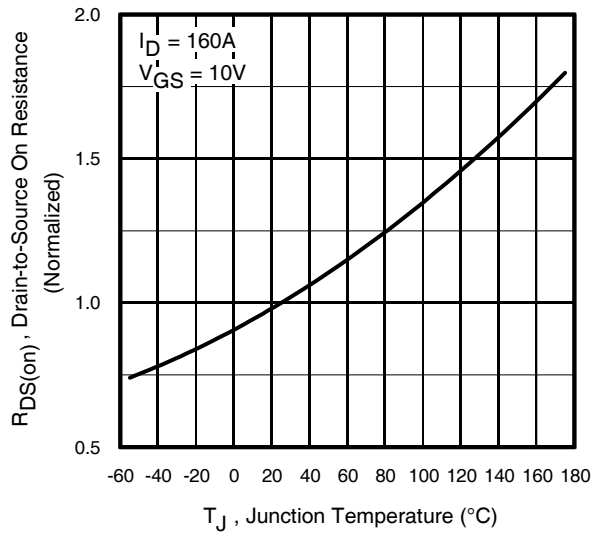

**Fig 10.** Normalized On-Resistance vs. Temperature

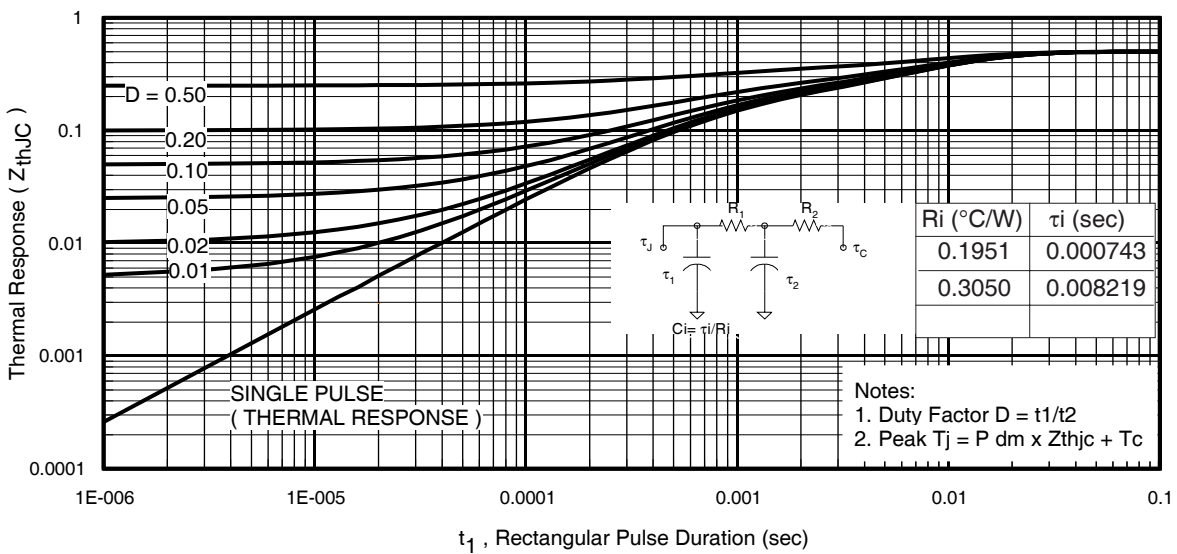

**Fig 11.** Maximum Effective Transient Thermal Impedance, Junction-to-Case

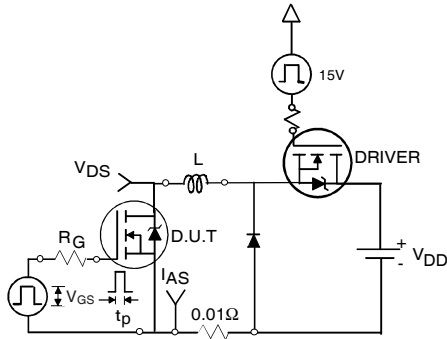

**Fig 12a.** Unclamped Inductive Test Circuit

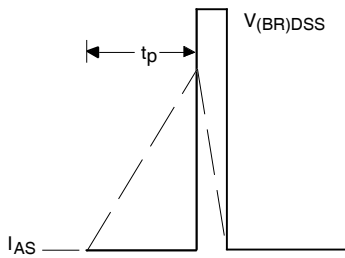

**Fig 12b.** Unclamped Inductive Waveforms

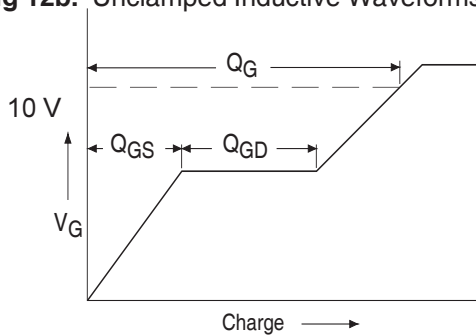

**Fig 13a.** Basic Gate Charge Waveform

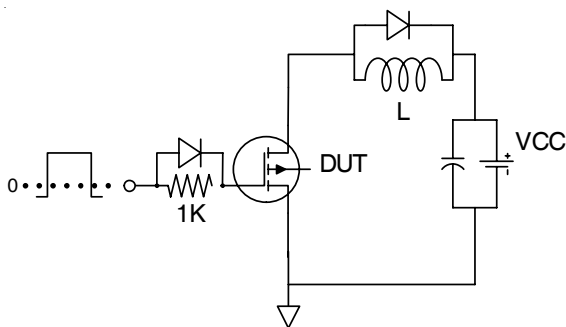

**Fig 13b.** Gate Charge Test Circuit

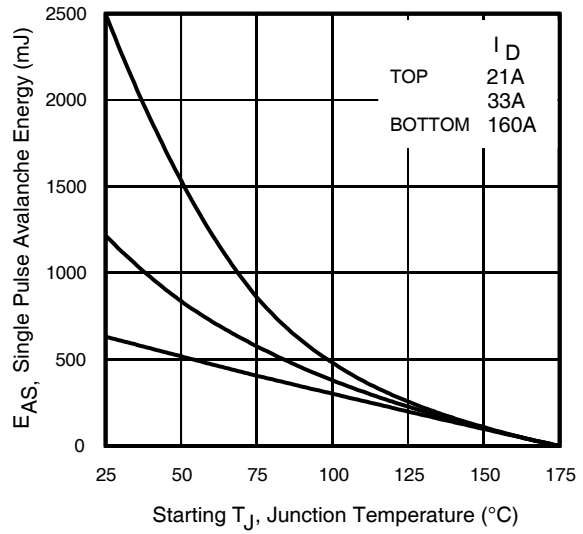

**Fig 12c.** Maximum Avalanche Energy vs. Drain Current

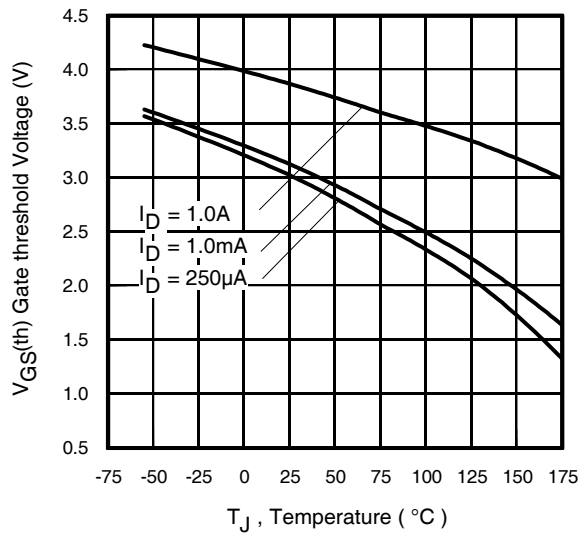

**Fig 14.** Threshold Voltage vs. Temperature

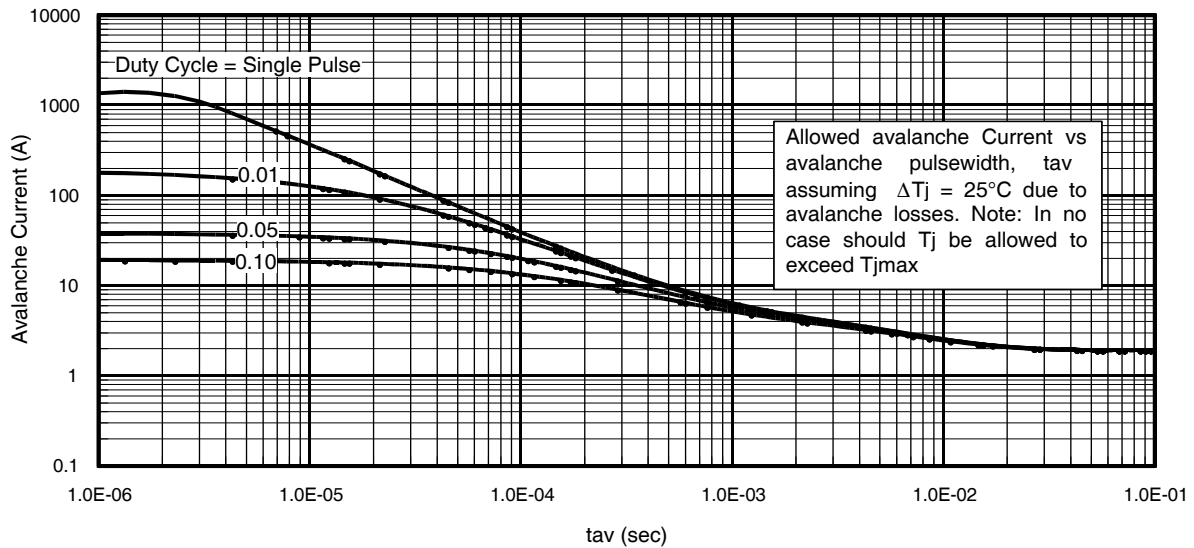

Fig 15. Typical Avalanche Current vs.Pulswidth

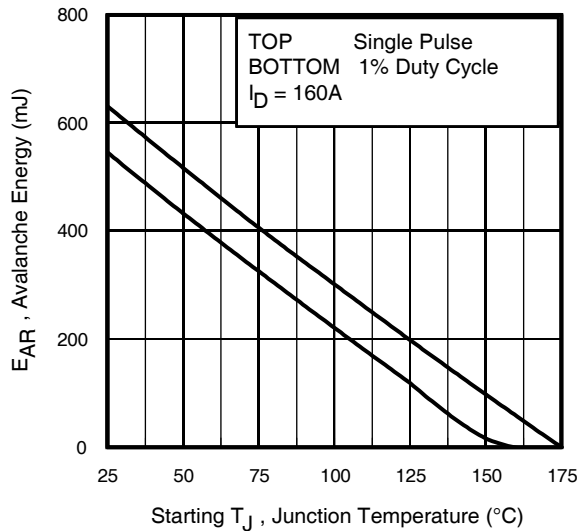

Fig 16. Maximum Avalanche Energy vs. Temperature

**Notes on Repetitive Avalanche Curves , Figures 15, 16:**  
(For further info, see AN-1005 at [www.irf.com](http://www.irf.com))

1. Avalanche failures assumption:  
Purely a thermal phenomenon and failure occurs at a temperature far in excess of  $T_{jmax}$ . This is validated for every part type.
2. Safe operation in Avalanche is allowed as long as  $T_{jmax}$  is not exceeded.
3. Equation below based on circuit and waveforms shown in Figures 12a, 12b.
4.  $P_{D(ave)}$  = Average power dissipation per single avalanche pulse.
5. BV = Rated breakdown voltage (1.3 factor accounts for voltage increase during avalanche).
6.  $I_{av}$  = Allowable avalanche current.
7.  $\Delta T$  = Allowable rise in junction temperature, not to exceed  $T_{jmax}$  (assumed as 25°C in Figure 15, 16).  
 $t_{av}$  = Average time in avalanche.  
 $D$  = Duty cycle in avalanche =  $t_{av} \cdot f$   
 $Z_{thJC}(D, t_{av})$  = Transient thermal resistance, see figure 11)

$$P_{D(ave)} = 1/2 ( 1.3 \cdot BV \cdot I_{av} ) = \Delta T / Z_{thJC}$$

$$I_{av} = 2\Delta T / [1.3 \cdot BV \cdot Z_{th}]$$

$$E_{AS(AR)} = P_{D(ave)} \cdot t_{av}$$

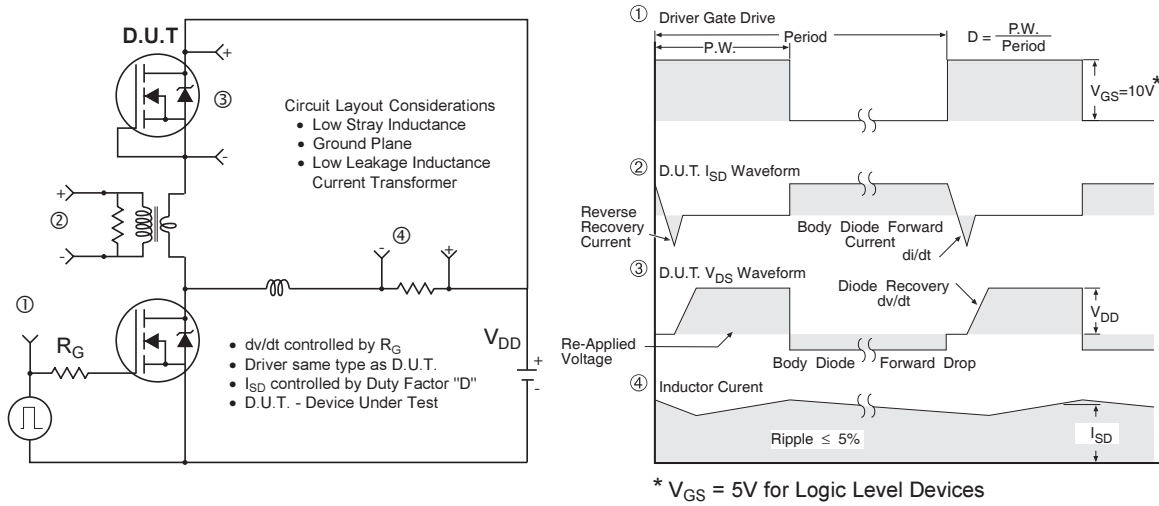

**Fig 17. Peak Diode Recovery  $dv/dt$  Test Circuit for N-Channel HEXFET® Power MOSFETs**

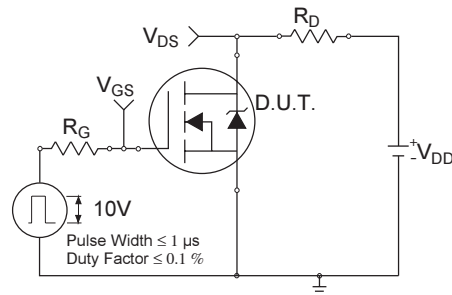

**Fig 18a. Switching Time Test Circuit**

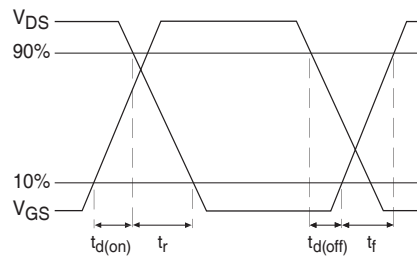

**Fig 18b. Switching Time Waveforms**

## D<sup>2</sup>Pak - 7 Pin Package Outline

Dimensions are shown in millimeters (inches)

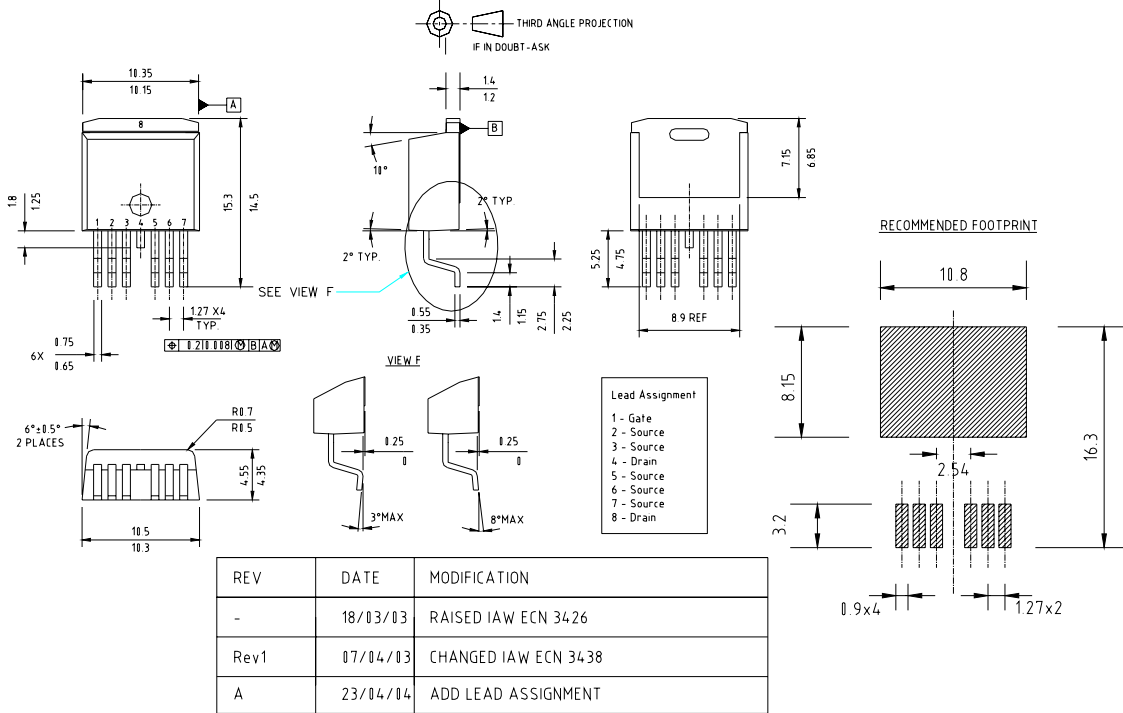

## D<sup>2</sup>Pak - 7 Pin Part Marking Information

EXAMPLE: THIS IS AN IRF2804S-7P WITH  
 LOT CODE 8024  
 ASSEMBLED ON WW02,2000  
 IN THE ASSEMBLY LINE "L"

Note: "P" in assembly line  
 position indicates "Lead Free"

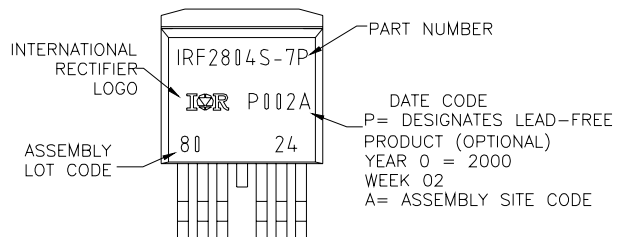
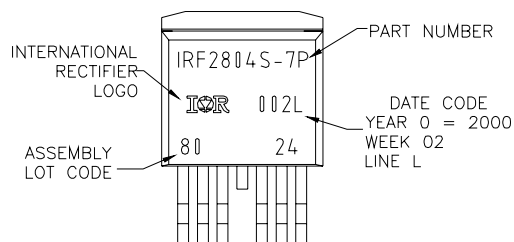

# IRF2804S-7P

International  
**IR** Rectifier

## D<sup>2</sup>Pak - 7 Pin Tape and Reel

### NOTES, TAPE & REEL, LABELLING:

#### 1. TAPE AND REEL.

- 1.1 REEL SIZE 13 INCH DIAMETER.
- 1.2 EACH REEL CONTAINING 800 DEVICES.
- 1.3 THERE SHALL BE A MINIMUM OF 42 SEALED POCKETS CONTAINED IN THE LEADER AND A MINIMUM OF 15 SEALED POKETS IN THE TRAILER.
- 1.4 PEEL STRENGTH MUST CONFORM TO THE SPEC. NO. 71-9667.
- 1.5 PART ORIENTATION SHALL BE AS SHOWN BELOW.
- 1.6 REEL MAY CONTAIN A MAXIMUM OF TWO UNIQUE LOT CODE/DATE CODE COMBINATIONS. REWORKED REELS MAY CONTAIN A MAXIMUM OF THREE UNIQUE LOT CODE/DATE CODE COMBINATIONS. HOWEVER, THE LOT CODES AND DATE CODES WITH THEIR RESPECTIVE QUANTITIES SHALL APPEAR ON THE BAR CODE LABEL FOR THE AFFECTED REEL.

#### 2. LABELLING (REEL AND SHIPPING BAG).

- 2.1 CUST. PART NUMBER (BAR CODE): IRF2804STRL-7P
- 2.2 CUST. PART NUMBER (TEXT CODE): IRF2804STRL-7P
- 2.3 I.R. PART NUMBER: IRF2804STRL-7P
- 2.4 QUANTITY:
- 2.5 VENDOR CODE: IR
- 2.6 LOT CODE:
- 2.7 DATE CODE:

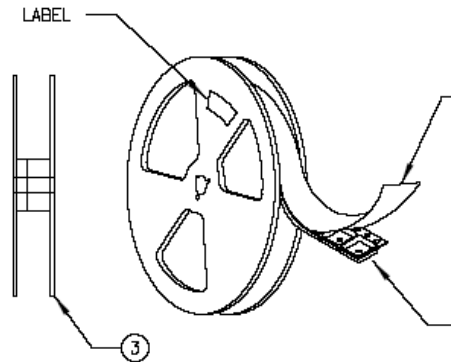
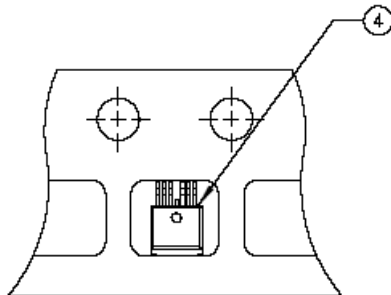

Data and specifications subject to change without notice.  
This product has been designed and qualified for the Automotive [Q101]market.  
Qualification Standards can be found on IR's Web site.

International  
**IR** Rectifier

**IR WORLD HEADQUARTERS:** 233 Kansas St., El Segundo, California 90245, USA Tel: (310) 252-7105  
TAC Fax: (310) 252-7903

Visit us at [www.irf.com](http://www.irf.com) for sales contact information. 06/05

[www.irf.com](http://www.irf.com)