

1PMT5.0AT1G/T3G Series



Description

The 1PMT5.0AT1G/T3G Series is designed to protect voltage sensitive components from high voltage, high energy transients. Excellent clamping capability, high surge capability, low Zener impedance and fast response time. The advanced packaging technique provides for a highly efficient micro miniature, space saving surface mount with its unique heatsink design. It has the same thermal performance as the SMA while being 50% smaller in footprint area, and delivering one of the lowest height profiles (1.1 mm) in the industry. Because of its small size, it is ideal for use in cellular phones, portable devices, business machines, power supplies and many other industrial/consumer applications.

Maximum Ratings and Thermal Characteristics

Rating	Symbol	Value	Unit
Maximum Ppk Dissipation, (PW=10/1000 μ s) (Note 1) (1PMT5.0A – 1PMT36A)	P_{PK}	200	W
Maximum Ppk Dissipation, (PW=10/1000 μ s) (Note 1) (1PMT40A – 1PMT58A)	P_{PK}	175	W
Maximum Ppk Dissipation, (PW=8/20 μ s) (Note 1)	P_{PK}	1000	W
DC Power Dissipation @ TA = 25°C (Note 2) Derate above 25°C Thermal Resistance, Junction-to-Ambient	T_J, T_{stg}	500 4.0 248	mW mW/°C °C
Thermal Resistance, Junction-to-Lead (Anode)	$R_{\theta J\text{anode}}$	35	°C/W
Maximum DC Power Dissipation (Note 3) Thermal Resistance, Junction-to-Tab (Cathode)	P_D $R_{\theta J\text{cathode}}$	3.2 23	W °C/W
Operating and Storage Temperature Range	T_J, T_{stg}	-55 to +150	°C

Stresses exceeding Maximum Ratings may damage the device. Maximum Ratings are stress ratings only. Functional operation above the Recommended Operating Conditions is not implied. Extended exposure to stresses above the Recommended Operating Conditions may affect device reliability.

1. Nonrepetitive current pulse at TA = 25°C.
2. Mounted with recommended minimum pad size, DC board FR-4.
3. At Tab (Cathode) temperature, Ttab = 75°C

Features

- Stand-off Voltage: 5.0 V – 58 V
- Peak Power
 - 200 W @ 1 ms (1PMT5.0A – 1PMT36A)
 - 175 W @ 1 ms (1PMT40A – 1PMT58A)
- Maximum Clamp Voltage @ Peak Pulse Current
- Low Leakage
- Response Time is Typically < 1 ns
- ESD Rating of Class 3 (> 16 kV) per Human Body Model
- Low Profile – Maximum Height of 1.1 mm
- Integral Heatsink/Locking Tabs
- Full Metallic Bottom Eliminates Flux Entrapment
- Small Footprint – Footprint Area of 8.45 mm²
- Lead Orientation in Tape: Cathode (Short) Lead to Sprocket Holes
- Cathode Indicated by Polarity Band
- These Devices are Pb-Free and are RoHS Compliant

Functional Diagram

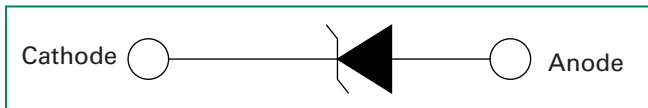

Additional Information



Datasheet



Resources



Samples

I-V Curve Characteristics ($T_A = 25^\circ\text{C}$ unless otherwise noted)

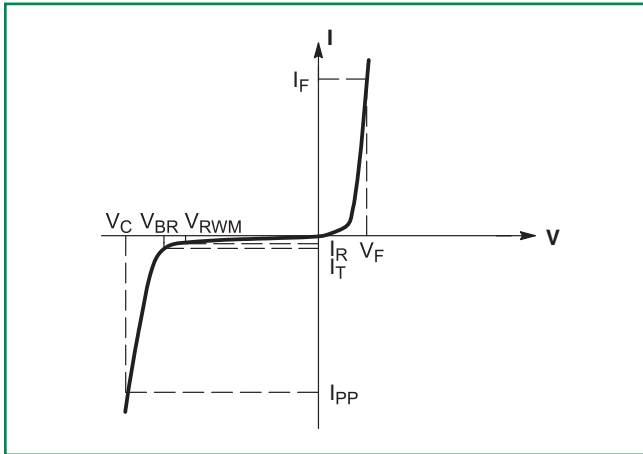

Symbol	Parameter
I_{PP}	Maximum Reverse Peak Pulse Current
V_C	Clamping Voltage @ I_{PP}
V_{RWM}	Working Peak Reverse Voltage
I_R	Maximum Reverse Leakage Current @ V_{RWM}
V_{BR}	Breakdown Voltage @ I_T
I_T	Test Current
I_F	Forward Current
V_F	Forward Voltage @ I_F

Ratings and Characteristic Curves

Figure 1. Pulse Rating Curve

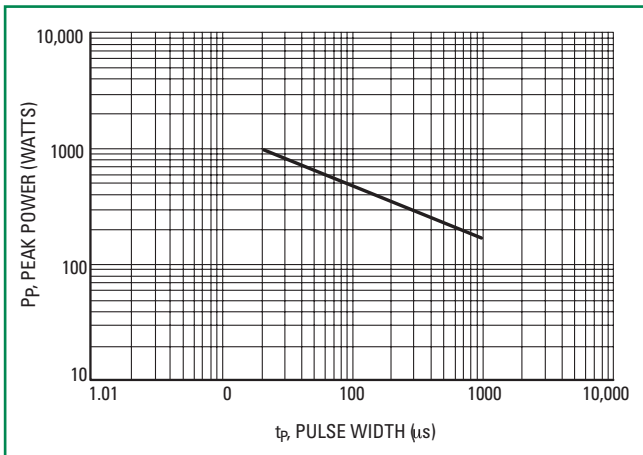

Figure 2. 10 X 1000 μs Pulse Waveform

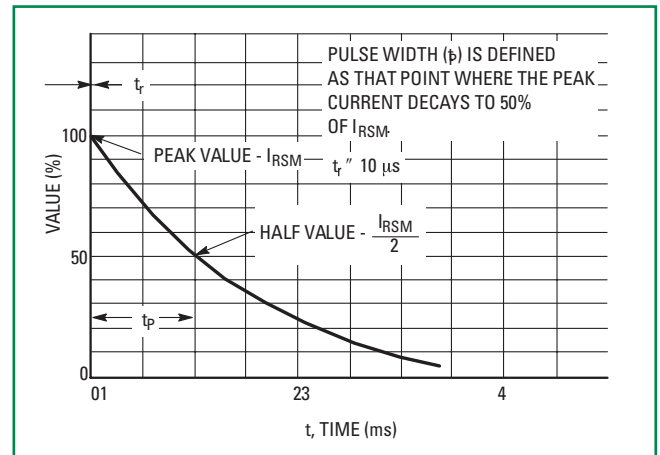

Figure 3. 8 X 20 μs Pulse Waveform

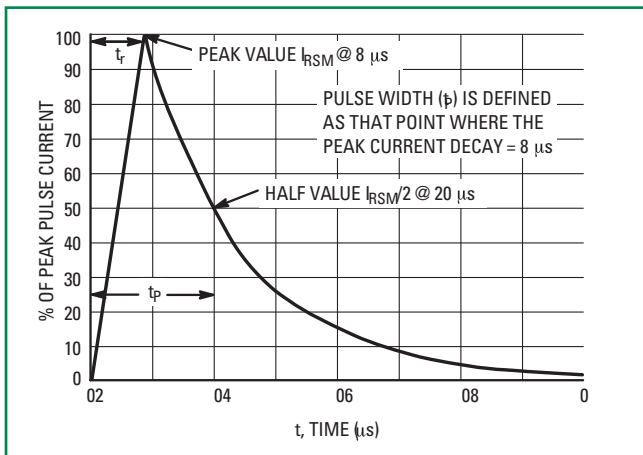

Figure 4. Pulse Derating Curve

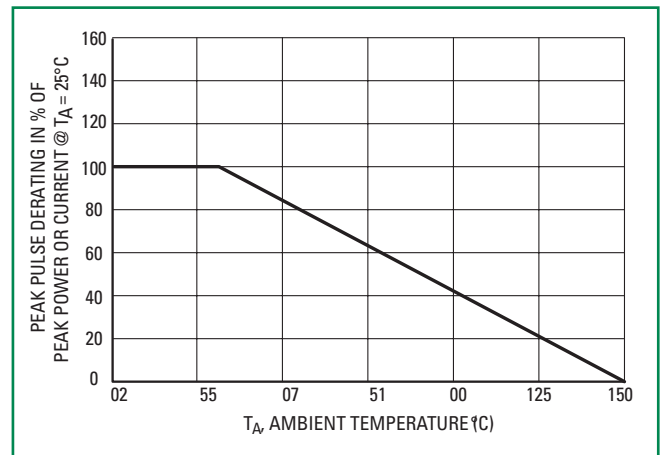

Figure 5. Typical Derating Factor for Duty Cycle

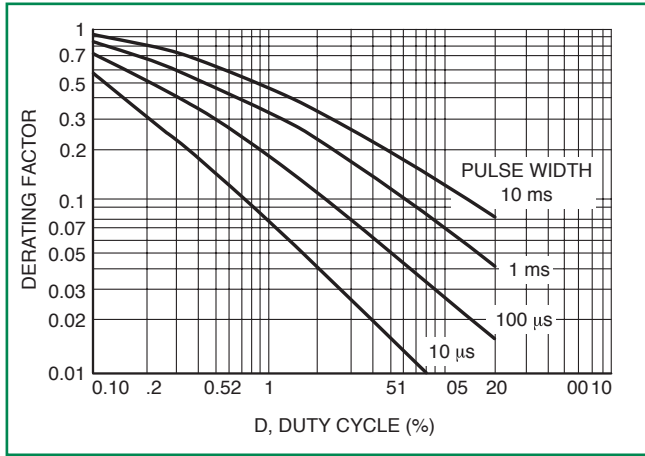

Figure 6. Steady State Power Derating

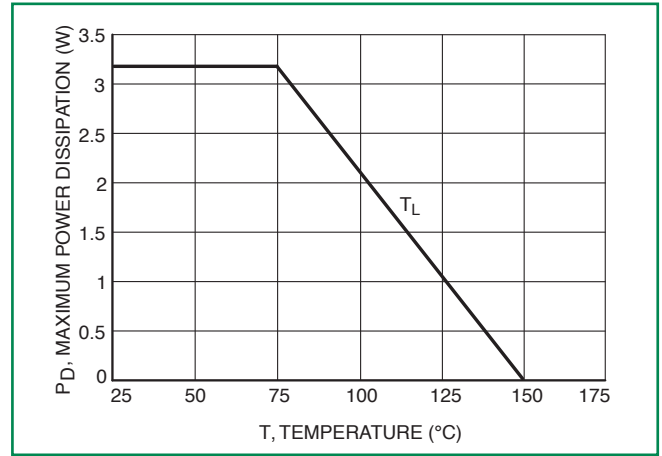

Figure 7. Forward Voltage

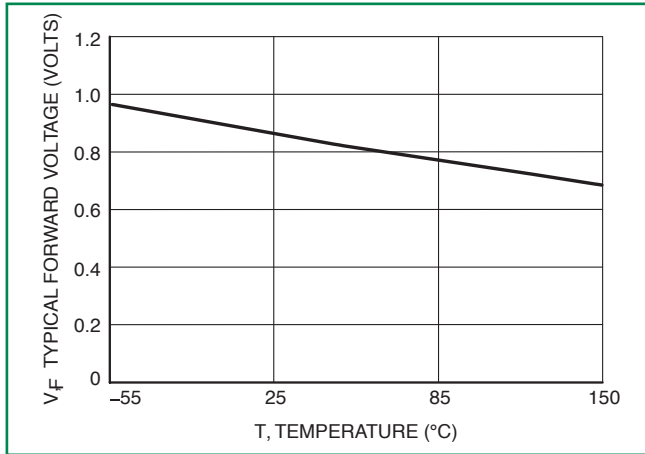
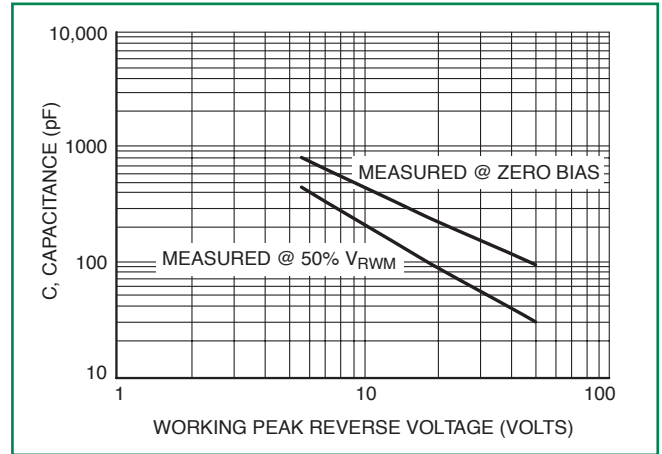
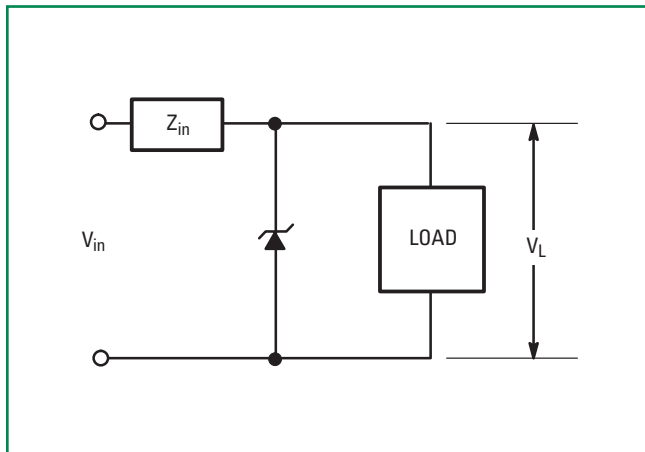

Figure 8. Capacitance vs. Working Peak Reverse Voltage



Typical Protection Circuit



Electrical Characteristics (TL = 30 °C unless otherwise noted, VF = 1.25 Volts @ 200 mA)

Device*	Device Marking	V _{RWM}	V _{BR} @ I _T (V) (Note 6)			I _T	I _R @ V _{RWM}	V _C @ I _{PP}	I _{PP} (A)
		(Note 5)	MIN	NOM	MAX	(mA)	(μA)	(V)	(Note 7)
1PMT5.0AT1G, T3G	MKE	5.0	6.4	6.7	7.0	10	50	9.2	21.7
1PMT7.0AT1G, T3G	MKM	7.0	7.78	8.2	8.6	10	30	12	16.7
1PMT12AT1G, T3G	MLE	12	13.3	14.0	14.7	1.0	1.0	19.9	10.1
1PMT16AT1G, T3G	MLP	16	17.8	18.75	19.7	1.0	1.0	26	7.7
1PMT18AT1G, T3G	MLT	18	20.0	21.0	22.1	1.0	1.0	29.2	6.8
1PMT22AT1G, T3G	MLX	22	24.4	25.6	26.9	1.0	1.0	35.5	5.6
1PMT24AT1G, T3G	MLZ	24	26.7	28.1	29.5	1.0	1.0	38.9	5.1
1PMT26AT1G, T3G	MME	26	28.9	30.4	31.9	1.0	1.0	42.1	4.8
1PMT28AT1G, T3G	MMG	28	31.1	32.8	34.4	1.0	1.0	45.4	4.4
1PMT30AT1G, T3G	MMK	30	33.3	35.1	36.8	1.0	1.0	48.4	4.1
1PMT33AT1G, T3G	MMM	33	36.7	38.7	40.6	1.0	1.0	53.3	3.8
1PMT36AT1G, T3G	MMP	36	40.0	42.1	44.2	1.0	1.0	58.1	3.4
1PMT40AT1G, T3G	MMR	40	44.4	46.8	49.1	1.0	1.0	64.5	2.7
1PMT48AT1G, T3G	MMX	48	53.3	56.1	58.9	1.0	1.0	77.4	2.3
1PMT51AT1G, T3G	MMZ	51	56.7	59.7	62.7	1.0	1.0	82.4	2.1
1PMT58AT1G, T3G	MNG	58	64.4	67.8	71.2	1.0	1.0	93.6	1.9

4. 1/2 sine wave (or equivalent square wave), PW = 8.3 ms, duty cycle = 4 pulses per minute maximum.

5. A transient suppressor is normally selected according to the Working Peak Reverse Voltage (VRWM) which should be equal to or greater than the DC or continuous peak operating voltage level.

6. VBR measured at pulse test current IT at ambient temperature of 25°C.

7. Surge current waveform per Figure 2 and derate per Figure 4.

*The "G" suffix indicates Pb-Free package.

Dimensions

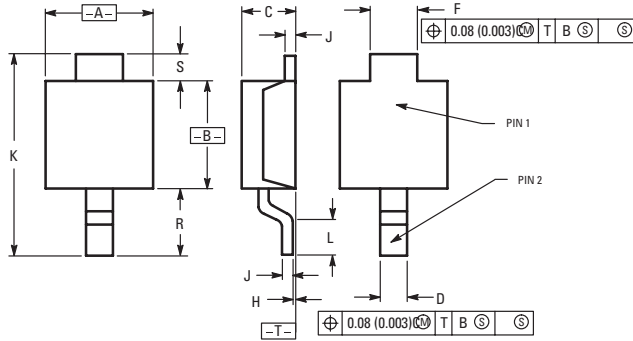

Dim	Inches		Millimeters	
	Min	Max	Min	Max
A	0.069	0.081	1.75	2.05
B	0.069	0.086	1.75	2.18
C	0.033	0.045	0.85	1.15
D	0.016	0.027	0.40	0.69
F	0.028	0.039	0.70	1.00
H	-0.002	+0.004	-0.05	+0.10
J	0.004	0.010	0.10	0.25
K	0.142	0.154	3.60	3.90
L	0.020	0.031	0.50	0.80
R	0.047	0.059	1.20	1.50
S	0.50 REF		0.50 REF	

- NOTES:
1. DIMENSIONING AND TOLERANCING PER ANSI Y14.5M, 1982.
 2. CONTROLLING DIMENSION: MILLIMETER.
 3. DIMENSIONS A AND B DO NOT INCLUDE MOLD FLASH, PROTRUSIONS OR GATE BURRS. MOLD FLASH, PROTRUSIONS OR GATE BURRS

Part Marking System

MARKING DIAGRAM

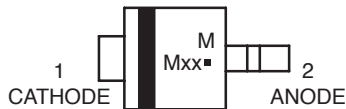

- M= Date Code
- Mxx= Specific Device Code (See Table on Page 3)
- =P b-Free Package

Soldering Footprint

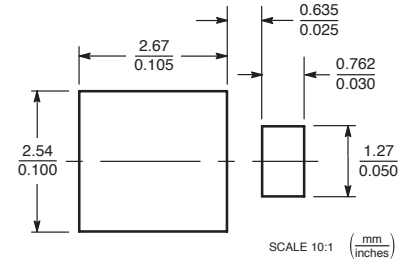

ORDERING INFORMATION

Device	Package	Shipping†
1PMTxxAT1G	POWERMITE (Pb-Free)	3,000 / Tape & Reel
1PMTxxAT3G	POWERMITE (Pb-Free)	12,000 / Tape & Reel

Flow/Wave Soldering (Solder Dipping)

Peak Temperature :	260°C
Dipping Time :	10 seconds

Physical Specifications

Case	Void-free, transfer-molded, thermosetting plastic
Leads	Modified L-Bend providing more contact area to bond pads
Finish	All external surfaces are corrosion resistant and leads are readily solderable
Mounting Position	Any

Disclaimer Notice - Information furnished is believed to be accurate and reliable. However, users should independently evaluate the suitability of and test each product selected for their own applications. Littelfuse products are not designed for, and may not be used in, all applications. Read complete Disclaimer Notice at: www.littelfuse.com/disclaimer-electronics.