

## SOT23, Low-Power $\mu$ P Supervisory Circuits with Battery Backup

### General Description

The MAX6361/MAX6363/MAX6364 supervisory circuits reduce the complexity and number of components required for power-supply monitoring and battery control functions in microprocessor ( $\mu$ P) systems. The circuits significantly improve system reliability and accuracy compared to that obtainable with separate ICs or discrete components. Their functions include  $\mu$ P reset, backup-battery switchover, and power failure warning.

The MAX6361/MAX6363/MAX6364 operate from supply voltages as low as +1.2V. The factory preset reset threshold voltage ranges from 2.32V to 4.63V (see *Ordering Information*). These devices provide a manual reset input (MAX6361), battery-on output (MAX6363), and an auxiliary adjustable reset input (MAX6364). In addition, each part type is offered in three reset output versions: an active-low push-pull reset, an active-low open-drain reset, and an active-high push-pull reset (see *Selector Guide* at end of data sheet).

### Applications

Computers	Fax Machines
Controllers	Industrial Control
Intelligent Instruments	POS Equipment
Critical $\mu$ P/ $\mu$ C	Portable/Battery-Powered
Power Monitoring	Equipment

### Pin Configurations

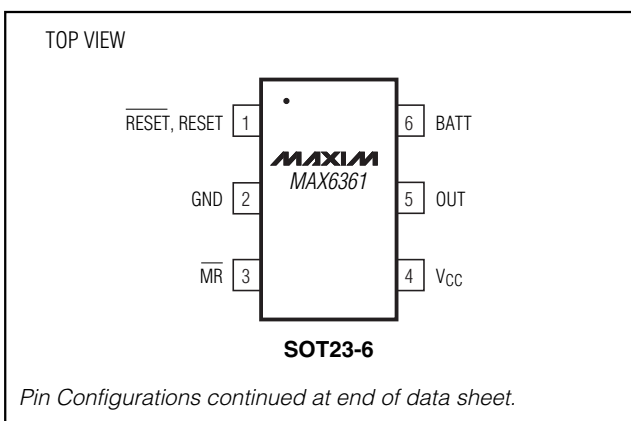

**Selector Guide appears at end of data sheet.**

**Typical Operating Circuit appears at end of data sheet.**

### Features

- ◆ Low +1.2V Operating Supply Voltage ( $V_{CC}$  or  $V_{BATT}$ )
- ◆ Precision Monitoring of +5.0V, +3.3V, +3.0V, and +2.5V Power-Supply Voltages
- ◆ Debounced Manual Reset Input (MAX6361)
- ◆ Battery-On Output Indicator (MAX6363)
- ◆ Auxiliary User-Adjustable RESET IN (MAX6364)
- ◆ Three Available Output Structures  
Push-Pull RESET, Open-Drain RESET, Push-Pull RESET
- ◆ RESET/RESET Valid Down to 1.2V Guaranteed ( $V_{CC}$  or  $V_{BATT}$ )
- ◆ Power-Supply Transient Immunity
- ◆ 150ms (min) Reset Timeout Period
- ◆ Small 6-Pin SOT23 Package

### Ordering Information

PART	TEMP. RANGE	PIN-PACKAGE
MAX6361LUT_ _-T	-40°C to +85°C	6 SOT23-6
MAX6361PUT_ _-T	-40°C to +85°C	6 SOT23-6
MAX6361HUT_ _-T	-40°C to +85°C	6 SOT23-6
MAX6363LUT_ _-T	-40°C to +85°C	6 SOT23-6
MAX6363PUT_ _-T	-40°C to +85°C	6 SOT23-6
MAX6363HUT_ _-T	-40°C to +85°C	6 SOT23-6
MAX6364LUT_ _-T	-40°C to +85°C	6 SOT23-6
MAX6364PUT_ _-T	-40°C to +85°C	6 SOT23-6
MAX6364HUT_ _-T	-40°C to +85°C	6 SOT23-6

**Note:** These parts offer a choice of reset threshold voltages. From Table 1, select the suffix corresponding to the desired threshold voltage and insert it into the part number to complete it. When ordering from the factory, there is a 2500-piece minimum on the SOT package (tape-and-reel only).

# SOT23, Low-Power $\mu$ P Supervisory Circuits with Battery Backup

## ABSOLUTE MAXIMUM RATINGS

Terminal Voltages (with respect to GND)

V <sub>CC</sub> , BATT, OUT	-0.3V to +6V
RESET (open drain)	-0.3V to +6V
BATT ON, MR, RESET IN	-0.3V to (V <sub>OUT</sub> + 0.3V)
RESET, RESET	-0.3V to (V <sub>OUT</sub> + 0.3V)

Input Current

V <sub>CC</sub> Peak	1A
V <sub>CC</sub> Continuous	250mA
BATT Peak	250mA
BATT Continuous	40mA
GND	75mA

Output Current

OUT	Short-Circuit Protection for up to 10s
RESET, RESET, BATT ON	20mA
Continuous Power Dissipation (T <sub>A</sub> = +70°C)	
6-Pin SOT23 (derate 8.70mW/°C above +70°C)	696mW
Operating Temperature Range	
MAX636_	-40°C to +85°C
Storage Temperature Range	-65°C to +150°C
Lead Temperature (soldering, 10s)	+300°C

Stresses beyond those listed under "Absolute Maximum Ratings" may cause permanent damage to the device. These are stress ratings only, and functional operation of the device at these or any other conditions beyond those indicated in the operational sections of the specifications is not implied. Exposure to absolute maximum rating conditions for extended periods may affect device reliability.

## ELECTRICAL CHARACTERISTICS

(V<sub>CC</sub> = +2.4V to +5.5V, V<sub>BATT</sub> = 3V, T<sub>A</sub> = -40°C to +85°C, reset not asserted, typical values are at T<sub>A</sub> = +25°C, unless otherwise noted.) (Note 1)

PARAMETER	SYMBOL	CONDITIONS	MIN	TYP	MAX	UNITS
Operating Voltage Range, V <sub>CC</sub> or V <sub>BATT</sub>	V <sub>CC</sub> , V <sub>BATT</sub>	No load (Note 2)	0		5.5	V
Supply Current (excluding I <sub>OUT</sub> )	I <sub>CC</sub>	No load, V <sub>CC</sub> > V <sub>TH</sub>	V <sub>CC</sub> = 2.8V	10	30	μA
			V <sub>CC</sub> = 3.6V	11	35	
			V <sub>CC</sub> = 5.5V	15	50	
I <sub>SUPPLY</sub> in Battery-Backup Mode (excluding I <sub>OUT</sub> )	I <sub>SUPPLY</sub>	V <sub>BATT</sub> = 2.8V, V <sub>CC</sub> = 0	T <sub>A</sub> = +25°C		1	μA
			T <sub>A</sub> = -40°C to +85°C		3	
BATT Standby Current	I <sub>BATT</sub>	5.5V > V <sub>CC</sub> > (V <sub>BATT</sub> + 0.2V)	T <sub>A</sub> = +25°C	-0.1	0.02	μA
			T <sub>A</sub> = -40°C to +85°C	-1.0	0.02	
V <sub>CC</sub> to OUT On-Resistance	R <sub>ON</sub>	V <sub>CC</sub> = 4.75V, I <sub>OUT</sub> ≤ 150mA			1.25	Ω
		V <sub>CC</sub> = 3.15V, I <sub>OUT</sub> ≤ 65mA			2.25	
		V <sub>CC</sub> = 2.38V, I <sub>OUT</sub> ≤ 25mA			4.6	
V <sub>OUT</sub> in Battery-Backup Mode		V <sub>BATT</sub> = 4.5V, I <sub>OUT</sub> ≤ 20mA			V <sub>BATT</sub> - 0.2	V
		V <sub>BATT</sub> = 3.0V, I <sub>OUT</sub> ≤ 10mA			V <sub>BATT</sub> - 0.15	
		V <sub>BATT</sub> = 2.25V, I <sub>OUT</sub> ≤ 5mA			V <sub>BATT</sub> - 0.15	
Battery-Switchover Threshold (V <sub>CC</sub> - V <sub>BATT</sub> )		V <sub>CC</sub> < V <sub>TH</sub>	Power-up		20	mV
			Power-down		-20	
Reset Threshold	V <sub>TH</sub>	MAX636_UT46	4.50	4.63	4.75	V
		MAX636_UT44	4.25	4.38	4.50	
		MAX636_UT31	3.00	3.08	3.15	
		MAX636_UT29	2.85	2.93	3.00	
		MAX636_UT26	2.55	2.63	2.70	
		MAX636_UT23	2.25	2.32	2.38	
V <sub>CC</sub> Falling Reset Delay		V <sub>CC</sub> falling at 10V/ms		35		μs
Reset-Active Timeout Period	t <sub>RP</sub>		150		280	ms

# SOT23, Low-Power $\mu$ P Supervisory Circuits with Battery Backup

MAX6361/MAX6363/MAX6364

## ELECTRICAL CHARACTERISTICS (continued)

( $V_{CC} = +2.4V$  to  $+5.5V$ ,  $V_{BATT} = 3V$ ,  $T_A = -40^{\circ}C$  to  $+85^{\circ}C$ , reset not asserted, typical values are at  $T_A = +25^{\circ}C$ , unless otherwise noted.) (Note 1)

PARAMETER	SYMBOL	CONDITIONS		MIN	TYP	MAX	UNITS
$\overline{RESET}$ Output Voltage	$V_{OL}$	Reset asserted, $V_{BATT} = 0$	$I_{SINK} = 1.6mA$ , $V_{CC} \geq 2.1V$			0.3	V
			$I_{SINK} = 100\mu A$ , $V_{CC} \geq 1.2V$			0.4	
	$V_{OH}$	Reset not asserted (MAX636_L only)	$I_{SOURCE} = 500\mu A$ , $V_{CC} \geq V_{TH(MAX)}$			$0.8 \cdot V_{CC}$	
RESET Output Voltage	$V_{OH}$	Reset asserted, $V_{BATT} = 0$	$I_{SOURCE} = 200\mu A$ , $V_{CC} \geq 1.2V$			$0.7 \cdot V_{CC}$	V
			$I_{SOURCE} = 1mA$ , $V_{CC} \geq 1.8V$			$0.8 \cdot V_{CC}$	
	$V_{OL}$	Reset not asserted	$I_{SINK} = 1.6mA$ , $V_{CC} \geq V_{TH(MAX)}$			0.3	
$\overline{RESET}$ Output Leakage Current	$I_{LK}$	MAX636_P only				1	$\mu A$
<b>MANUAL RESET (MAX6361 only)</b>							
$\overline{MR}$ Input Voltage	$V_{IL}$					$0.3 \cdot V_{CC}$	V
	$V_{IH}$					$0.7 \cdot V_{CC}$	
Pull-Up Resistance				20			$k\Omega$
Minimum Pulse Width				1			$\mu s$
Glitch Immunity		$V_{CC} = 3.3V$			100		ns
$\overline{MR}$ to Reset Delay		$V_{CC} = 3.3V$			120		ns
<b>BATT ON (MAX6363 only)</b>							
Output Voltage	$V_{OL}$	$I_{SINK} = 3.2mA$ , $V_{BATT} = 2.1V$				0.4	V
Output Short-Circuit Current		Sink current, $V_{CC} = 5V$			60		mA
		Source current, $V_{BATT} \geq 2V$		10	30	100	$\mu A$
<b>RESET IN (MAX6364 only)</b>							
Input Threshold				1.185	1.235	1.285	V
RESET IN Leakage Current					$\pm 0.01$	$\pm 25$	nA
RESET IN to Reset Delay		Overdrive voltage = 50mV, RESET IN falling			1.5		$\mu s$

**Note 1:** Overtemperature limits are guaranteed by design and not production tested.

**Note 2:**  $V_{BATT}$  can be 0 anytime or  $V_{CC}$  can go down to 0 if  $V_{BATT}$  is active (except at startup).

# SOT23, Low-Power $\mu\text{P}$ Supervisory Circuits with Battery Backup

## Typical Operating Characteristics

( $T_A = +25^\circ\text{C}$ , unless otherwise noted.)

**SUPPLY CURRENT vs. TEMPERATURE (NO LOAD)**

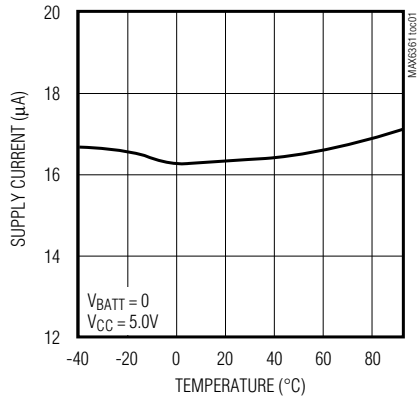

**BATTERY SUPPLY CURRENT (BACKUP MODE) vs. TEMPERATURE**

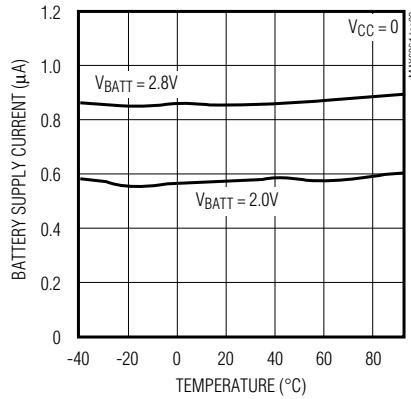

**BATTERY TO OUT ON-RESISTANCE vs. TEMPERATURE**

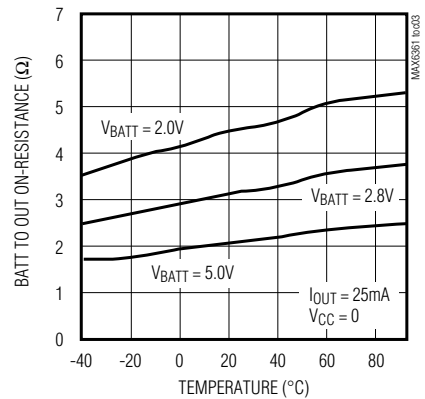

**V<sub>CC</sub> TO OUT ON-RESISTANCE vs. TEMPERATURE**

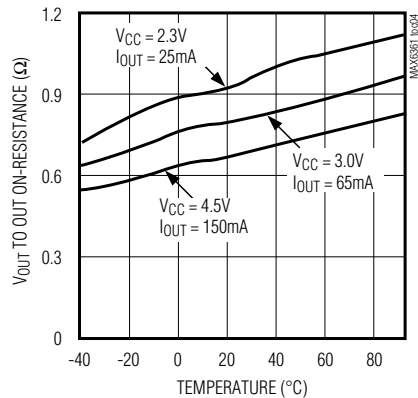

**RESET TIMEOUT PERIOD vs. TEMPERATURE**

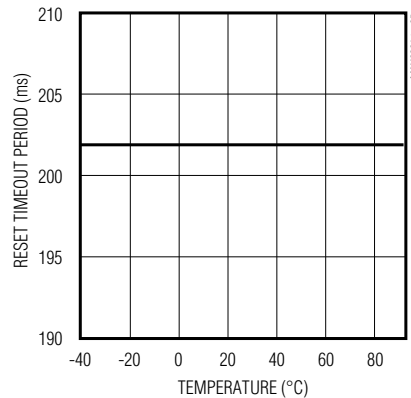

**V<sub>CC</sub> TO RESET PROPAGATION DELAY vs. TEMPERATURE**

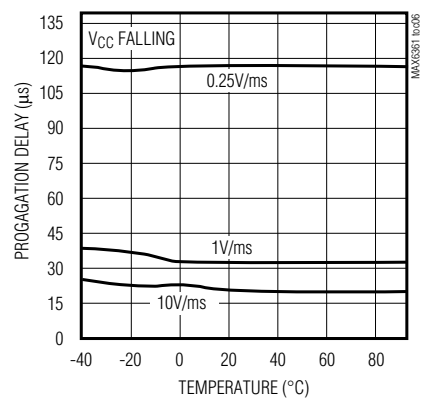

**RESET THRESHOLD vs. TEMPERATURE**

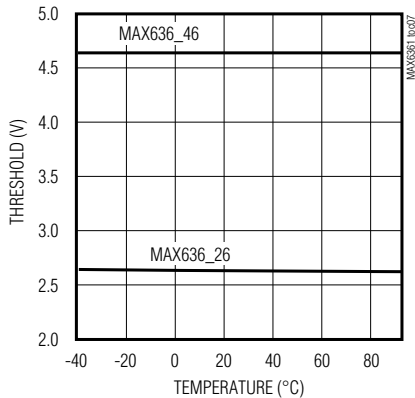

**MAXIMUM TRANSIENT DURATION vs. RESET THRESHOLD OVERDRIVE**

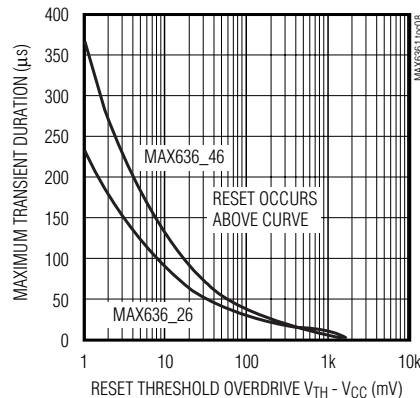

**BATTERY SUPPLY CURRENT vs. SUPPLY VOLTAGE**

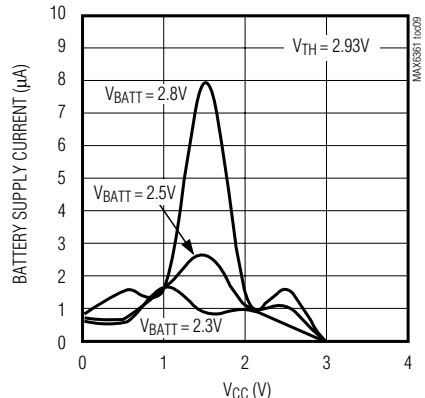

# SOT23, Low-Power $\mu$ P Supervisory Circuits with Battery Backup

## Typical Operating Characteristics (continued)

( $T_A = +25^\circ\text{C}$ , unless otherwise noted.)

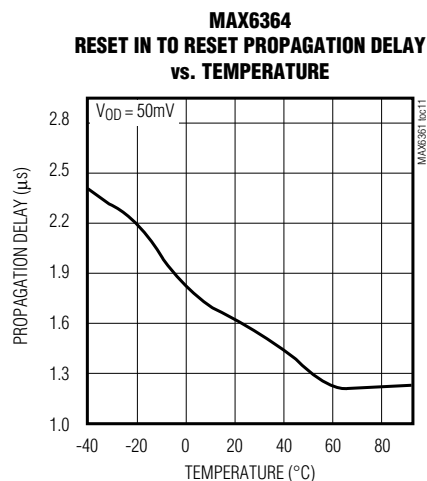
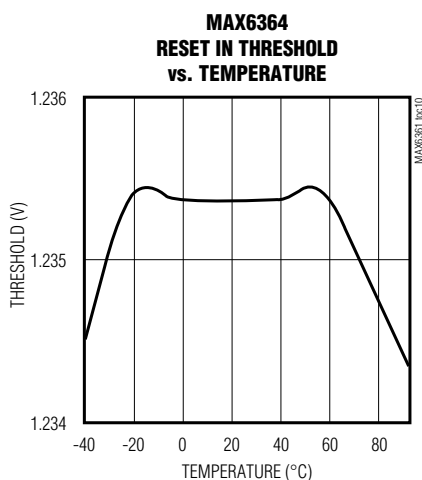

## Pin Description

PIN	NAME	FUNCTION
1	RESET	Active-High Reset Output (for H versions). RESET remains high while $V_{CC}$ is below the reset threshold and for at least 150ms ( $t_{RP}$ ) after $V_{CC}$ rises above the reset threshold. RESET also asserts when $\overline{MR}$ or RESET IN is low.
	$\overline{RESET}$	Active-Low Reset Output (for L and P versions). $\overline{RESET}$ remains low while $V_{CC}$ is below the reset threshold and for at least 150ms ( $t_{RP}$ ) after $V_{CC}$ rises above the reset threshold. $\overline{RESET}$ also asserts when $\overline{MR}$ or RESET IN is low.
2	GND	Ground
3	$\overline{MR}$	<b>MAX6361</b> Manual-Reset Input. Maintaining logic low on $\overline{MR}$ asserts a reset. Reset output remains asserted for at least 150ms ( $t_{RP}$ ) after $\overline{MR}$ transitions from low to high. Leave unconnected or connected to $V_{CC}$ if not used.
	BATT ON	<b>MAX6363</b> Battery-On Output. BATT ON goes high in battery backup mode.
	RESET IN	<b>MAX6364</b> Reset Input. When RESET IN falls below 1.235V, reset is asserted. Reset output remains asserted as long as RESET IN is low and for at least 150ms ( $t_{RP}$ ) after RESET IN goes high.
4	$V_{CC}$	Supply Voltage. Reset is asserted when $V_{CC}$ drops below the reset threshold voltage ( $V_{TH}$ ). Reset remains asserted until $V_{CC}$ rises above $V_{TH}$ and for at least 150ms after $V_{CC}$ rises above $V_{TH}$ .
5	OUT	Output. OUT sources from $V_{CC}$ when it is above the reset threshold ( $V_{TH}$ ), and from the greater of $V_{CC}$ or BATT when $V_{CC}$ is below $V_{TH}$ .
6	BATT	Backup-Battery Input. When $V_{CC}$ falls below the reset threshold, BATT switches to OUT if $V_{BATT}$ is 20mV greater than $V_{CC}$ . When $V_{CC}$ rises 20mV above $V_{BATT}$ , $V_{CC}$ switches to OUT. The 40mV hysteresis prevents repeated switching if $V_{CC}$ falls slowly.

## Detailed Description

The *Typical Operating Circuit* shows a typical connection for the MAX6361/MAX6363/MAX6364 family. OUT powers the static random-access memory (SRAM). OUT is internally connected to  $V_{CC}$  if  $V_{CC}$  is greater than the reset threshold, or to the greater of  $V_{CC}$  or  $V_{BATT}$  when  $V_{CC}$  is less than the reset threshold. OUT can supply up

to 150mA from  $V_{CC}$ . When  $V_{CC}$  is higher than  $V_{BATT}$ , the BATT ON (MAX6363) output is low. When  $V_{CC}$  is lower than  $V_{BATT}$ , an internal MOSFET connects the backup battery to OUT. The on-resistance of the MOSFET is a function of backup-battery voltage and is shown in the Battery to Out On-Resistance vs. Temperature graph in the *Typical Operating Characteristics* section.

# SOT23, Low-Power $\mu\text{P}$ Supervisory Circuits with Battery Backup

## Backup-Battery Switchover

In a brownout or power failure, it may be necessary to preserve the contents of the RAM. With a backup battery installed at BATT, the MAX6361/MAX6363/MAX6364 automatically switch the RAM to backup power when  $V_{CC}$  falls. The MAX6363 has a BATT ON output that goes high when in battery-backup mode. These devices require two conditions before switching to battery-backup mode:

- 1)  $V_{CC}$  must be below the reset threshold.
- 2)  $V_{CC}$  must be below  $V_{BATT}$ . Table 2 lists the status of the inputs and outputs in battery-backup mode. The device will not power up if the only voltage source is on BATT. OUT will only power up from  $V_{CC}$  at startup.

## Manual Reset Input (MAX6361 only)

Many  $\mu\text{P}$ -based products require manual reset capability, allowing the operator, a test technician, or external logic circuitry to initiate a reset. For the MAX6361, a logic low on  $\overline{\text{MR}}$  asserts reset. Reset remains asserted while  $\overline{\text{MR}}$  is low, and for a minimum of 150ms ( $t_{RP}$ ) after it returns high.  $\overline{\text{MR}}$  has an internal 20k $\Omega$  pull-up resistor. This input can be driven with TTL/CMOS logic levels or with open-drain/collector outputs. Connect a normally open momentary switch from  $\overline{\text{MR}}$  to GND to create a manual reset function; external debounce circuitry is not required. If  $\overline{\text{MR}}$  is driven from long cables or the device is used in a noisy environment, connect a 0.1 $\mu\text{F}$  capacitor from  $\overline{\text{MR}}$  to GND to provide additional noise immunity.

## Reset In (MAX6364 only)

RESET IN is compared to an internal 1.235V reference. If the voltage at RESET IN is less than 1.235V, reset is asserted. The RESET IN comparator may be used as an undervoltage detector to signal a failing power supply. It can also be used as a secondary power-supply reset monitor.

## Reset Output

A  $\mu\text{P}$ 's reset input starts the  $\mu\text{P}$  in a known state. The MAX6361/MAX6363/MAX6364  $\mu\text{P}$  supervisory circuits assert a reset to prevent code-execution errors during power-up, power-down, and brownout conditions. RESET is guaranteed to be a logic low or high depending on the device chosen (see *Ordering Information*). RESET or  $\overline{\text{RESET}}$  asserts when  $V_{CC}$  is below the reset threshold and for at least 150ms ( $t_{RP}$ ) after  $V_{CC}$  rises above the reset threshold. RESET or  $\overline{\text{RESET}}$  also asserts when  $\overline{\text{MR}}$  is low (MAX6361) and when RESET IN is less than 1.235V (MAX6364).

## Applications Information

### Operation Without a Backup Power Source

The MAX6361/MAX6363/MAX6364 were designed for battery-backed applications. If a backup battery is not used, connect  $V_{CC}$  to OUT and connect BATT to GND.

### Replacing the Backup Battery

If BATT is decoupled with a 0.1 $\mu\text{F}$  capacitor to ground, the backup power source can be removed while  $V_{CC}$  remains valid without danger of triggering a reset pulse. The device does not enter battery-backup mode when  $V_{CC}$  stays above the reset threshold voltage.

### Negative-Going $V_{CC}$ Transients

These supervisors are relatively immune to short-duration, negative-going  $V_{CC}$  transients. Resetting the  $\mu\text{P}$  when  $V_{CC}$  experiences only small glitches is usually not desirable.

The *Typical Operating Characteristics* section shows a graph of Maximum Transient Duration vs. Reset Threshold Overdrive for which reset is not asserted. The graph was produced using negative-going  $V_{CC}$  pulses, starting at  $V_{CC}$  and ending below the reset threshold by the magnitude indicated (reset threshold overdrive). The graph shows the maximum pulse width

Table 1. Reset Threshold Ranges

SUFFIX	RESET THRESHOLD RANGES (V)		
	MIN	TYP	MAX
46	4.50	4.63	4.75
44	4.25	4.38	4.50
31	3.00	3.08	3.15
29	2.85	2.93	3.00
26	2.55	2.63	2.70
23	2.25	2.32	2.38

Table 2. Input and Output Status in Battery-Backup Mode

PIN	STATUS
$V_{CC}$	Disconnected from OUT
OUT	Connected to BATT
BATT	Connected to OUT. Current drawn from the battery is less than 1 $\mu\text{A}$ (at $V_{BATT} = 2.8\text{V}$ , excluding $I_{OUT}$ ) when $V_{CC} = 0$ .
$\overline{\text{RESET}}/\overline{\text{RESET}}$	Asserted
BATT ON	High state
$\overline{\text{MR}}$ , RESET IN	Inputs ignored

# SOT23, Low-Power $\mu$ P Supervisory Circuits with Battery Backup

## Selector Guide

MAX6361/MAX6363/MAX6364

PART	MANUAL RESET INPUT, MR	BATT ON	RESET IN	RESET PUSH-PULL	RESET OPEN-DRAIN	RESET PUSH-PULL
MAX6361LUT__	✓			✓		
MAX6361PUT__	✓				✓	
MAX6361HUT__	✓					✓
MAX6363LUT__		✓		✓		
MAX6363PUT__		✓			✓	
MAX6363HUT__		✓				✓
MAX6364LUT__			✓	✓		
MAX6364PUT__			✓		✓	
MAX6364HUT__			✓			✓

## Device Marking Codes

PART	TOP MARK	PART	TOP MARK	PART	TOP MARK
MAX6361LUT23	AAEI	MAX6363LUT23	AAFS	MAX6364LUT23	AAGK
MAX6361LUT26	AAEH	MAX6363LUT26	AAFR	MAX6364LUT26	AAGJ
MAX6361LUT29*	AAEG	MAX6363LUT29*	AAFQ	MAX6364LUT29*	AAGI
MAX6361LUT31	AAEF	MAX6363LUT31	AAFP	MAX6364LUT31	AAGH
MAX6361LUT44	AAEE	MAX6363LUT44	AAFO	MAX6364LUT44	AAGG
MAX6361LUT46*	AAED	MAX6363LUT46*	AAFN	MAX6364LUT46*	AAGF
MAX6361PUT23	AAEO	MAX6363PUT23	AAFY	MAX6364PUT23	AAGQ
MAX6361PUT26	AAEN	MAX6363PUT26	AAFX	MAX6364PUT26	AAGP
MAX6361PUT29*	AAEM	MAX6363PUT29*	AAFW	MAX6364PUT29*	AAGO
MAX6361PUT31	AAEL	MAX6363PUT31	AAFV	MAX6364PUT31	AAGN
MAX6361PUT44	AAEK	MAX6363PUT44	AAFU	MAX6364PUT44	AAGM
MAX6361PUT46*	AAEJ	MAX6363PUT46*	AAFT	MAX6364PUT46*	AAGL
MAX6361HUT23	AAEU	MAX6363HUT23	AAGE	MAX6364HUT23	AAGW
MAX6361HUT26	AAET	MAX6363HUT26	AAGD	MAX6364HUT26	AAGV
MAX6361HUT29	AAES	MAX6363HUT29	AAGC	MAX6364HUT29	AAGU
MAX6361HUT31	AAER	MAX6363HUT31	AAGB	MAX6364HUT31	AAGT
MAX6361HUT44	AAEQ	MAX6363HUT44	AAGA	MAX6364HUT44	AAGS
MAX6361HUT46*	AAEP	MAX6363HUT46*	AAFZ	MAX6364HUT46*	AAGR

\*Sample stock generally held on standard versions only. Contact factory for availability of nonstandard versions.

that a negative-going  $V_{CC}$  transient can typically have without triggering a reset pulse. As the amplitude of the transient increases (i.e., goes further below the reset threshold), the maximum allowable pulse width decreases. Typically, a  $V_{CC}$  transient that goes 100mV below the reset threshold and lasts for 30 $\mu$ s will not trigger a reset pulse.

A 0.1 $\mu$ F bypass capacitor mounted close to the  $V_{CC}$  pin provides additional transient immunity.

# SOT23, Low-Power $\mu$ P Supervisory Circuits with Battery Backup

## Pin Configurations (continued)

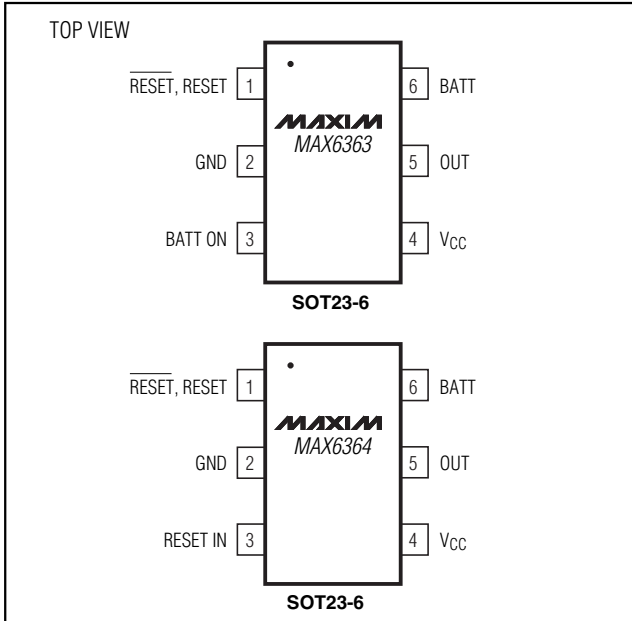

## Typical Operating Circuit

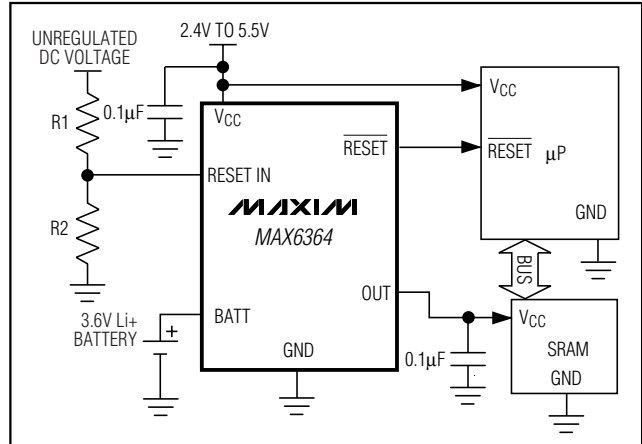

## Chip Information

TRANSISTOR COUNT: 720

## Package Information

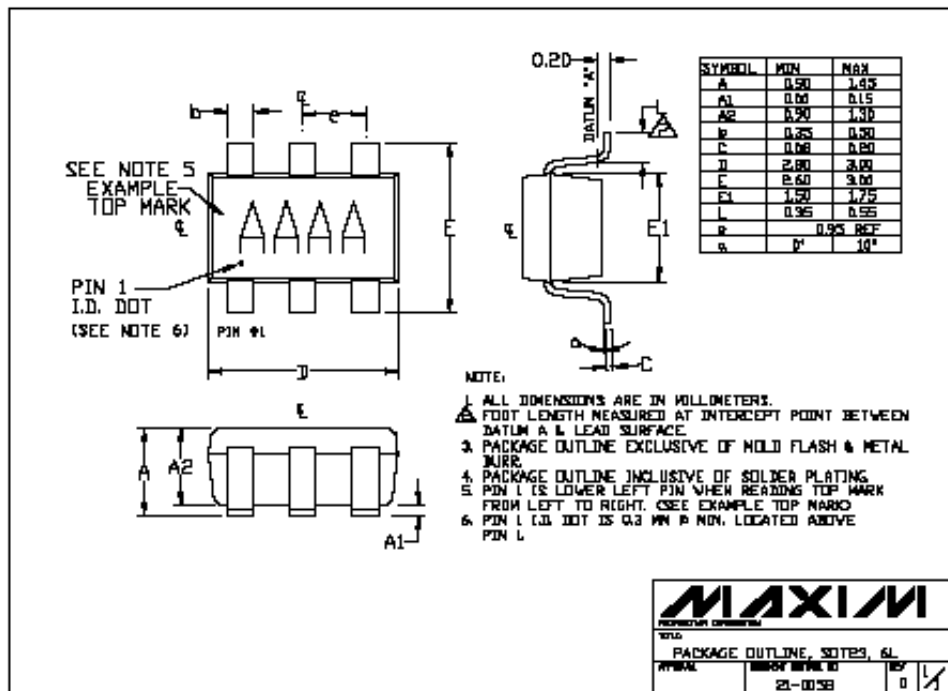

Maxim cannot assume responsibility for use of any circuitry other than circuitry entirely embodied in a Maxim product. No circuit patent licenses are implied. Maxim reserves the right to change the circuitry and specifications without notice at any time.

8 Maxim Integrated Products, 120 San Gabriel Drive, Sunnyvale, CA 94086 408-737-7600