

N-Channel Enhancement-Mode Vertical DMOS FET

Features

- ▶ Free from secondary breakdown
- ▶ Low power drive requirement
- ▶ Ease of paralleling
- ▶ Low C_{ISS} and fast switching speeds
- ▶ Excellent thermal stability
- ▶ Integral source-drain diode
- ▶ High input impedance and high gain

Applications

- ▶ Motor controls
- ▶ Converters, amplifiers, and switches
- ▶ Power supply circuits
- ▶ Drivers (relays, hammers, solenoids, lamps, memories, displays, bipolar transistors, etc.)

Ordering Information

| Part Number | Package Options | Packing |
|-----------------|-------------------|-----------|
| VN2450N3-G | TO-92 | 1000/Bag |
| VN2450N3-G P002 | TO-92 | 2000/Reel |
| VN2450N3-G P003 | TO-92 | 2000/Reel |
| VN2450N3-G P005 | TO-92 | 2000/Reel |
| VN2450N3-G P013 | TO-92 | 2000/Reel |
| VN2450N3-G P014 | TO-92 | 2000/Reel |
| VN2450N8-G | TO-243AA (SOT-89) | 2000/Reel |

-G denotes a lead (Pb)-free / RoHS compliant package
 Refer to 'P0xx' Tape & Reel Specs for P002, P003, P005, P013, and P014 TO-92
 Taping Specifications and Winding Styles
 Contact factory for Wafer / Die availability.
 Devices in Wafer / Die form are lead (Pb)-free / RoHS compliant.

Absolute Maximum Ratings

| Parameter | Value |
|-----------------------------------|-----------------------------------|
| Drain-to-source voltage | BV_{DSS} |
| Drain-to-gate voltage | BV_{DGS} |
| Gate-to-source voltage | $\pm 20V$ |
| Operating and storage temperature | $-55^{\circ}C$ to $+150^{\circ}C$ |

Absolute Maximum Ratings are those values beyond which damage to the device may occur. Functional operation under these conditions is not implied. Continuous operation of the device at the absolute rating level may affect device reliability. All voltages are referenced to device ground.

Typical Thermal Resistance

| Package | θ_{ja} |
|-------------------|--------------------|
| TO-92 | $132^{\circ}C/W$ |
| TO-243AA (SOT-89) | $133^{\circ}C/W^*$ |

* Mounted on FR5 Board, 25mm x 25mm x 1.57mm

General Description

This enhancement-mode (normally-off) transistor utilizes a vertical DMOS structure and Supertex's well-proven silicon-gate manufacturing process. This combination produces a device with the power handling capabilities of bipolar transistors and with the high input impedance and positive temperature coefficient inherent in MOS devices. Characteristic of all MOS structures, this device is free from thermal runaway and thermally induced secondary breakdown.

Supertex's vertical DMOS FETs are ideally suited to a wide range of switching and amplifying applications where high breakdown voltage, high input impedance, low input capacitance, and fast switching speeds are desired.

Product Summary

| BV_{DSS}/BV_{DGS} | $R_{DS(ON)}$ (max) | $I_{D(ON)}$ (min) |
|---------------------|-----------------------|----------------------|
| 500V | 13Ω | 500mA |

Pin Configuration

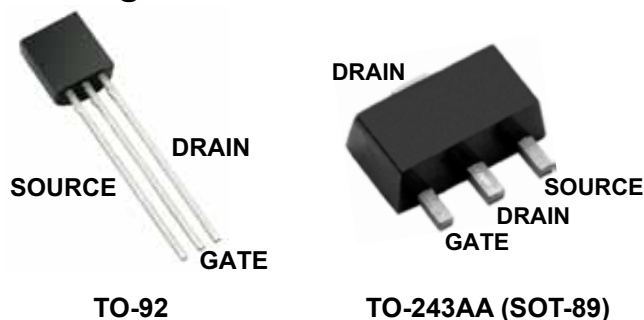

Product Marking

| | |
|---------|---------------------------|
| SiVN | YY = Year Sealed |
| 2 4 5 0 | WW = Week Sealed |
| YYWW | _____ = "Green" Packaging |

Package may or may not include the following marks: Si or TO-92

| | |
|-------|---------------------------|
| VN4EW | W = Code for week sealed |
| _____ | _____ = "Green" Packaging |

Package may or may not include the following marks: Si or TO-243AA (SOT-89)

Thermal Characteristics

| Package | I_D (continuous) [†] | I_D (pulsed) | Power Dissipation @ $T_A = 25^\circ\text{C}$ | I_{DR} [‡] | I_{DRM} |
|-------------------|------------------------------------|-------------------|-------------------------------------------------|-----------------------|-----------|
| TO-92 | 200mA | 650mA | 1.0W | 200mA | 650mA |
| TO-243AA (SOT-89) | 250mA | 750mA | 1.6W [‡] | 250mA | 750mA |

Notes:

[†] I_D (continuous) is limited by max rated T_j .

[‡] Mounted on FR5 Board, 25mm x 25mm x 1.57mm.

Electrical Characteristics ($T_A = 25^\circ\text{C}$ unless otherwise specified)

| Sym | Parameter | Min | Typ | Max | Units | Conditions |
|---------------------|--------------------------------------------|-----|-----|------|----------|------------------------------------------------------------------------------|
| BV_{DSS} | Drain-to-source breakdown voltage | 500 | - | - | V | $V_{GS} = 0V, I_D = 2.0mA$ |
| $V_{GS(th)}$ | Gate threshold voltage | 1.5 | - | 4.0 | V | $V_{GS} = V_{DS}, I_D = 1.0mA$ |
| $\Delta V_{GS(th)}$ | Change in $V_{GS(th)}$ with temperature | - | - | -5.5 | mV/°C | $V_{GS} = V_{DS}, I_D = 1.0mA$ |
| I_{GSS} | Gate body leakage current | - | - | 100 | nA | $V_{GS} = \pm 20V, V_{DS} = 0V$ |
| I_{DSS} | Zero gate voltage drain current | - | - | 10 | μA | $V_{GS} = 0V,$ $V_{DS} = \text{Max Rating}$ |
| | | - | - | 1.0 | mA | $V_{DS} = 0.8 \text{ Max Rating},$ $V_{GS} = 0V, T_A = 125^\circ\text{C}$ |
| $I_{D(ON)}$ | On-state drain current | 0.5 | - | - | A | $V_{GS} = 10V, V_{DS} = 25V$ |
| $R_{DS(ON)}$ | Static drain-to-source on-state resistance | - | - | 20 | Ω | $V_{GS} = 4.5V, I_D = 100mA$ |
| | | - | - | 13 | | $V_{GS} = 10V, I_D = 400mA$ |
| $\Delta R_{DS(ON)}$ | Change in $R_{DS(ON)}$ with temperature | - | - | 1.7 | %/°C | $V_{GS} = 10V, I_D = 400mA$ |
| G_{FS} | Forward transconductance | 50 | - | - | mmho | $V_{DS} = 25V, I_D = 200mA$ |
| C_{ISS} | Input capacitance | - | - | 150 | pF | $V_{GS} = 0V,$ $V_{DS} = 25V,$ $f = 1.0MHz$ |
| C_{OSS} | Common source output capacitance | - | - | 50 | | |
| C_{RSS} | Reverse transfer capacitance | - | - | 25 | | |
| $t_{d(ON)}$ | Turn-on delay time | - | - | 10 | ns | $V_{DD} = 25V,$ $I_D = 250mA,$ $R_{GEN} = 25\Omega$ |
| t_r | Rise time | - | - | 10 | | |
| $t_{d(OFF)}$ | Turn-off delay time | - | - | 25 | | |
| t_f | Fall time | - | - | 20 | | |
| V_{SD} | Diode forward voltage drop | - | - | 1.5 | V | $V_{GS} = 0V, I_{SD} = 400mA$ |

Notes:

- All D.C. parameters 100% tested at 25°C unless otherwise stated. (Pulse test: 300 μs pulse, 2% duty cycle.)
- All A.C. parameters sample tested.

Switching Waveforms and Test Circuit

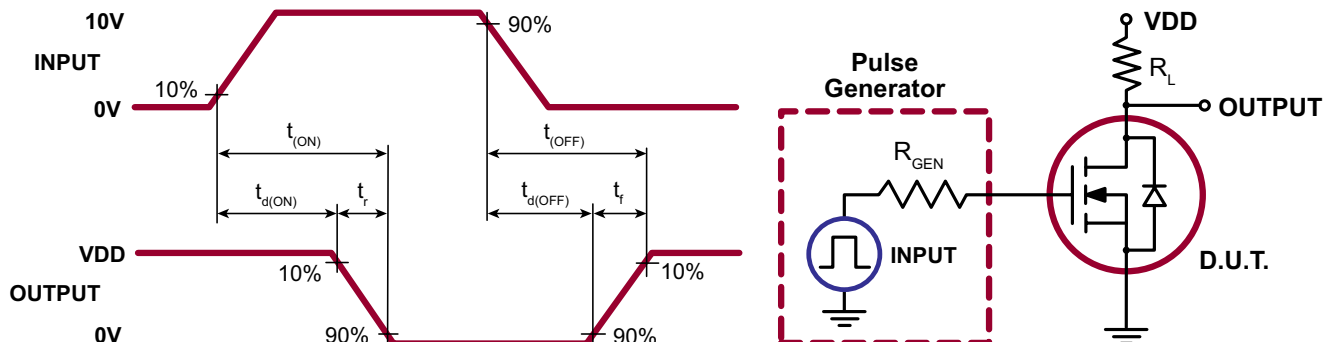

Typical Performance Curves

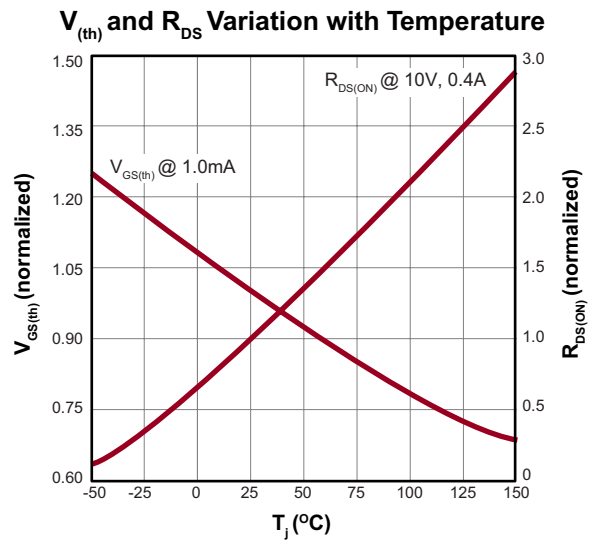
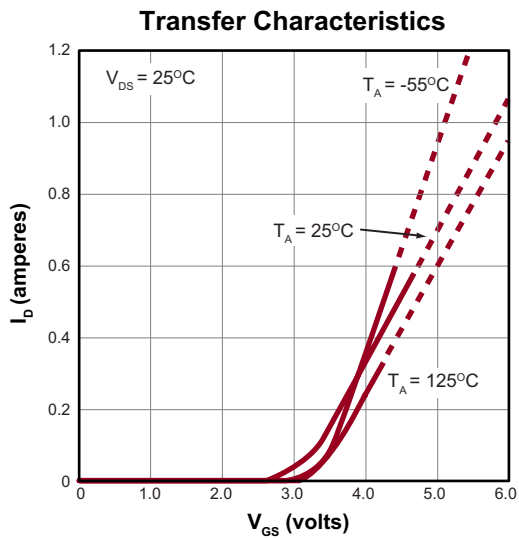
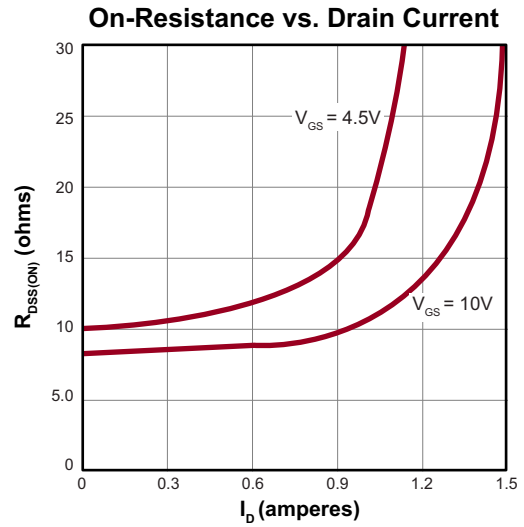
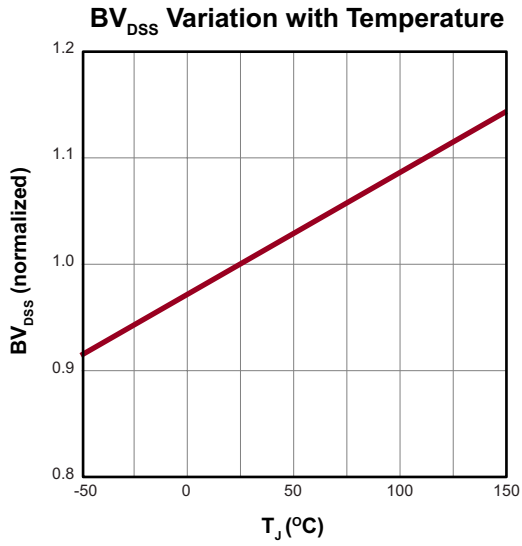

Capacitance vs. Drain-to-Source Voltage

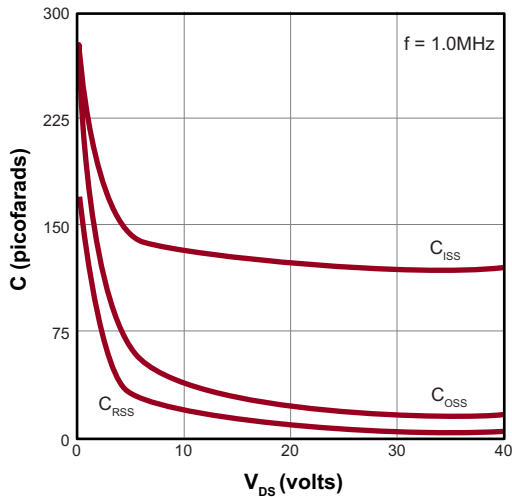

Gate Drive Dynamic Characteristics

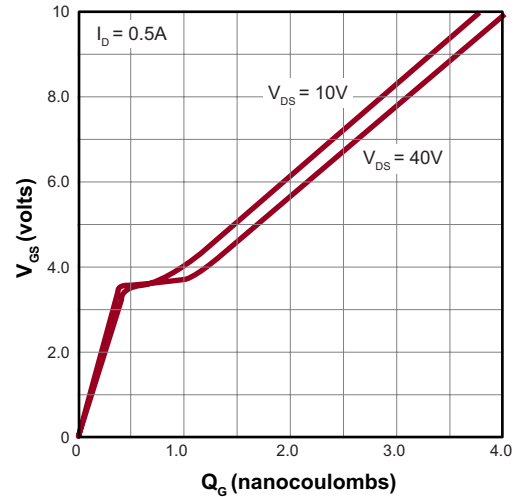

Typical Performance Curves (cont.)

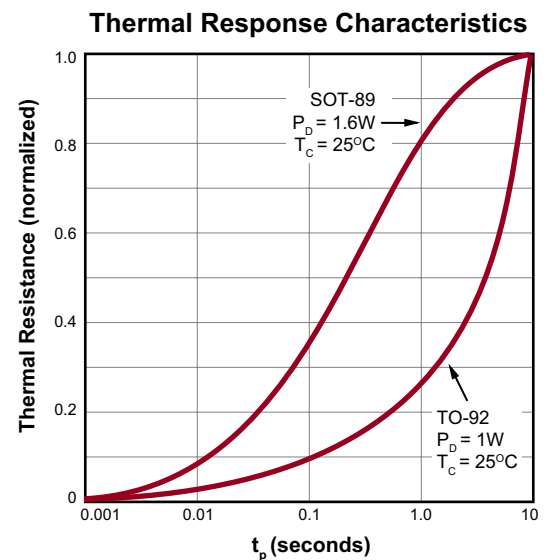
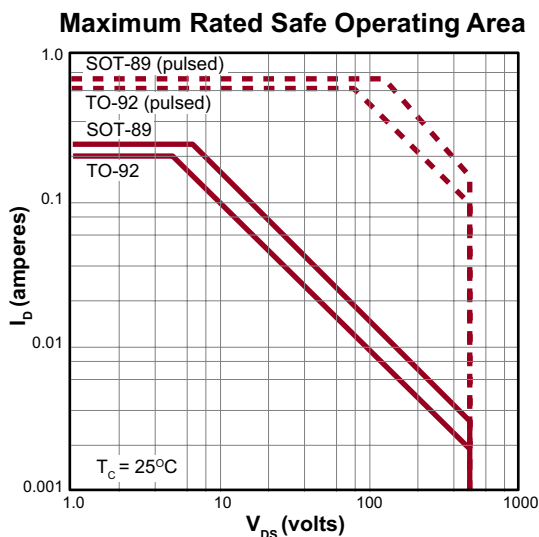
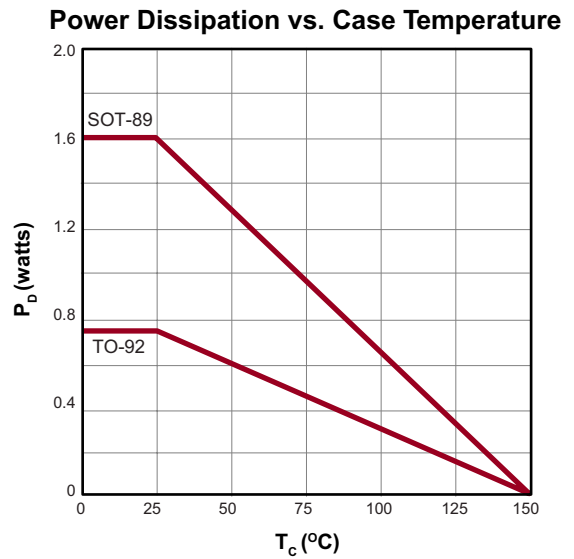
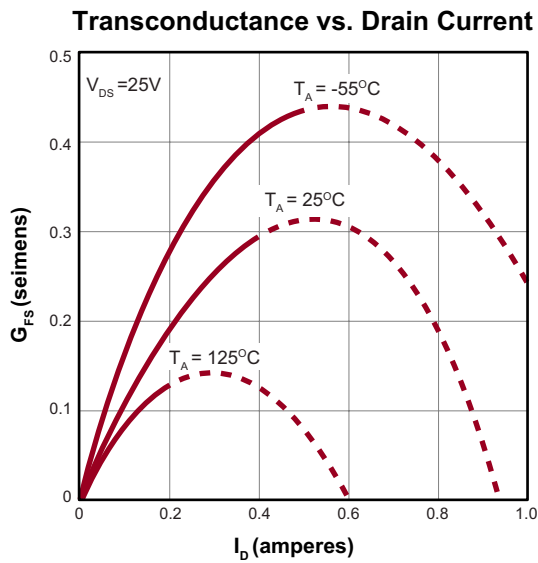
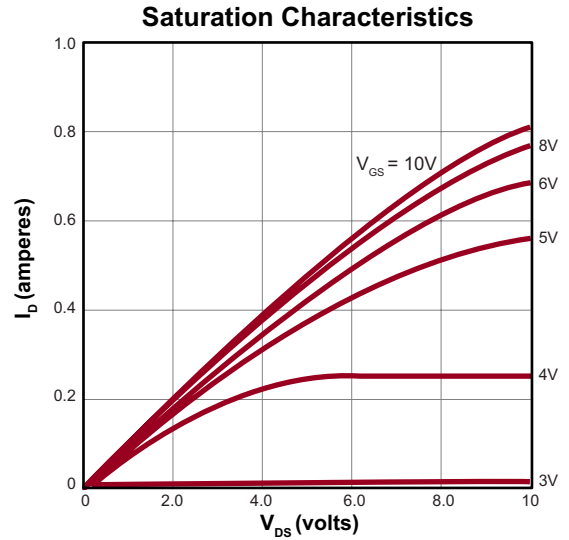
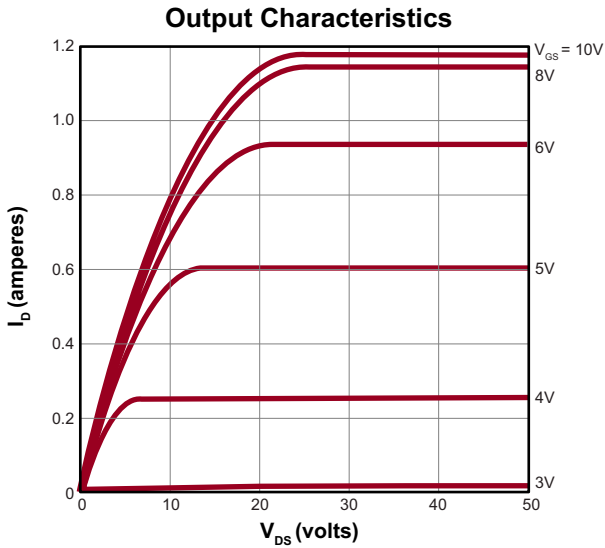

3-Lead TO-92 Package Outline (N3)

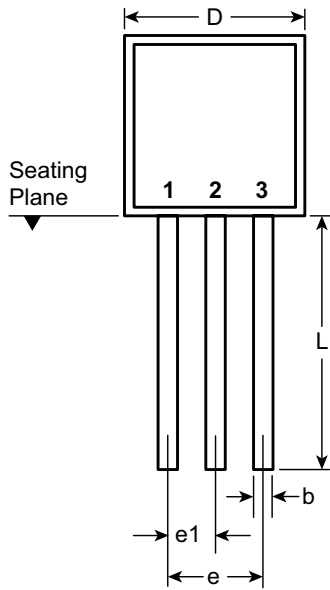

Front View

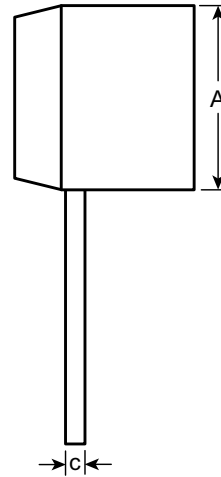

Side View

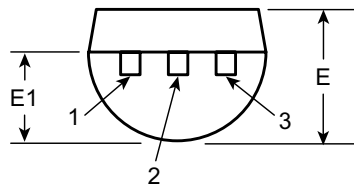

Bottom View

| Symbol | A | b | c | D | E | E1 | e | e1 | L | |
|---------------------|-----|------|-------|-------|------|------|------|------|------|-------|
| Dimensions (inches) | MIN | .170 | .014† | .014† | .175 | .125 | .080 | .095 | .045 | .500 |
| | NOM | - | - | - | - | - | - | - | - | - |
| | MAX | .210 | .022† | .022† | .205 | .165 | .105 | .105 | .055 | .610* |

JEDEC Registration TO-92.

* This dimension is not specified in the JEDEC drawing.

† This dimension differs from the JEDEC drawing.

Drawings not to scale.

Supertex Doc.#: DSPD-3TO92N3, Version E041009.

3-Lead TO-243AA (SOT-89) Package Outline (N8)

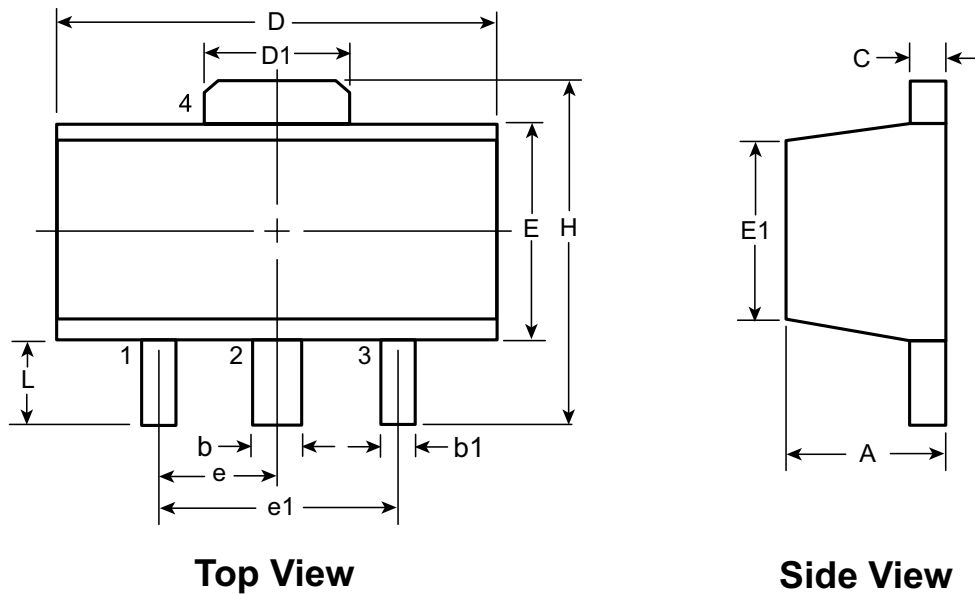

| Symbol | A | b | b1 | C | D | D1 | E | E1 | e | e1 | H | L | | |
|--------------------|-----|------|------|------|------|------|------|------|-------------------|-------------|-------------|------|-------------------|---|
| Dimensions (mm) | MIN | 1.40 | 0.44 | 0.36 | 0.35 | 4.40 | 1.62 | 2.29 | 2.00 [†] | 1.50 BSC | 3.00 BSC | 3.94 | 0.73 [†] | |
| | NOM | - | - | - | - | - | - | - | - | | | - | - | - |
| | MAX | 1.60 | 0.56 | 0.48 | 0.44 | 4.60 | 1.83 | 2.60 | 2.29 | | | 4.25 | 1.20 | |

JEDEC Registration TO-243, Variation AA, Issue C, July 1986.

[†] This dimension differs from the JEDEC drawing

Drawings not to scale.

Supertex Doc. #: DSPD-3TO243AAN8, Version F111010.

(The package drawing(s) in this data sheet may not reflect the most current specifications. For the latest package outline information go to <http://www.supertex.com/packaging.html>.)

Supertex inc. does not recommend the use of its products in life support applications, and will not knowingly sell them for use in such applications unless it receives an adequate "product liability indemnification insurance agreement." **Supertex inc.** does not assume responsibility for use of devices described, and limits its liability to the replacement of the devices determined defective due to workmanship. No responsibility is assumed for possible omissions and inaccuracies. Circuitry and specifications are subject to change without notice. For the latest product specifications refer to the **Supertex inc.** (website: <http://www.supertex.com>)