

PLEASE CHECK WWW.MOLEX.COM FOR LATEST PART INFORMATION

Part Number: [39880-0524](#)
Status: **Active**
Overview: Eurostyle™ Terminal Blocks
Description: 5.08mm Pitch Beau™ Eurostyle™ Low Profile, Two Level Terminal Block, Modular, 24 Circuits

Documents:

[3D Model](#) [RoHS Certificate of Compliance \(PDF\)](#)
[Drawing \(PDF\)](#)

Agency Certification

CSA LR25562
 UL E48521

General

Product Family Terminal Blocks
 Series [39880](#)
 Application N/A
 Component Type One Piece
 Overview [Eurostyle™ Terminal Blocks](#)
 Product Name Eurostyle™ Multi-Level
 Type Euro Block
 UPC 822348046225

Physical

Circuits (Loaded) 24
 Entry Angle Horizontal
 Flammability 94V-0
 Lock to Mating Part None
 Number of Rows 2
 Orientation Vertical
 PC Tail Length 3.50mm
 PCB Retention N/A
 PCB Thickness - Recommended 2.40mm
 Panel Mount No
 Pitch - Mating Interface 5.08mm
 Pitch - Termination Interface 5.08mm
 Polarized to Mating Part N/A
 Shrouded Fully
 Stackable Yes
 Temperature Range - Operating 110°C
 Wire Size AWG 16, 18, 20, 22, 24, 26, 28, 30
 Wire Size mm² 0.20 - 1.50

Electrical

Current - Maximum per Contact 13.5A
 Voltage - Maximum 300V

Solder Process Data

Lead-free Process Capability Wave Capable (TH only)

Material Info

Old Part Number 882124

Reference - Drawing Numbers

Sales Drawing SD-39880-005

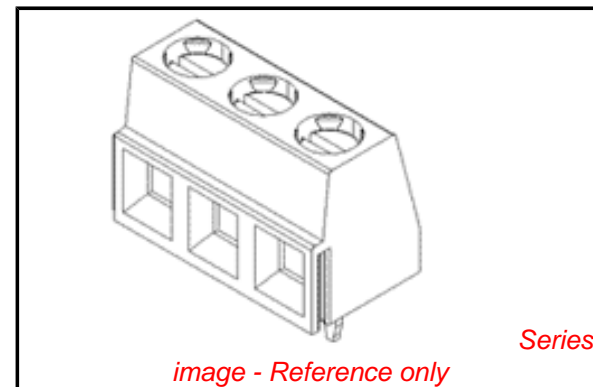

EU RoHS

ELV and RoHS Compliant
REACH SVHC
 Not Reviewed
Low-Halogen Status
 Not Reviewed

China RoHS



Need more information on product environmental compliance?

Email productcompliance@molex.com
 For a multiple part number RoHS Certificate of Compliance, [click here](#)

Please visit the [Contact Us](#) section for any non-product compliance questions.

Search Parts in this Series

[39880Series](#)

This document was generated on 10/27/2014

PLEASE CHECK WWW.MOLEX.COM FOR LATEST PART INFORMATION