

# SWITCHMODE™

## Soft Recovery Power Rectifier

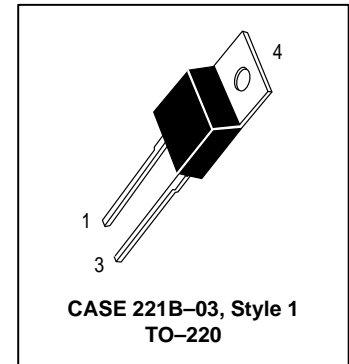
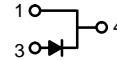
### Plastic TO-220 Package

**MSR860**

**SOFT RECOVERY  
POWER RECTIFIER  
8.0 AMPERES  
600 VOLTS**

Designed for use as free wheeling diodes in variable speed motor control applications and other average frequency switching power supplies. These state-of-the-art devices have the following features:

- Soft Recovery with Guaranteed Low Reverse Recovery Charge ( $Q_{RR}$ ) and Peak Reverse Recovery Current ( $I_{RRM}$ )
- 150°C Operating Junction Temperature
- Popular TO-220 Package
- Epoxy meets UL94,  $V_0 @ 1/8''$
- Low Forward Voltage
- Low Leakage Current
- High Temperature Glass Passivated Junction



#### Mechanical Characteristics:

- Case: Molded Epoxy
- Weight: 1.9 Grams (approximately)
- Finish: All External Surfaces Corrosion Resistant and Terminal Leads Readily Solderable
- Lead Temperature for Soldering Purposes: 260°C Max. for 10 Seconds
- Shipped in 50 Units per Plastic Tube
- Marking: MSR860

#### MAXIMUM RATINGS

| Rating                                                                                                       | Symbol                          | Value       | Unit             |
|--------------------------------------------------------------------------------------------------------------|---------------------------------|-------------|------------------|
| Peak Repetitive Reverse Voltage<br>Working Peak Reverse Voltage<br>DC Blocking Voltage                       | $V_{RRM}$<br>$V_{RWM}$<br>$V_R$ | 600         | V                |
| Average Rectified Forward Current (At Rated $V_R$ , $T_C = 125^\circ\text{C}$ )                              | $I_O$                           | 8.0         | A                |
| Peak Repetitive Forward Current (At Rated $V_R$ , Square Wave, 20 kHz, $T_C = 125^\circ\text{C}$ )           | $I_{FRM}$                       | 16          | A                |
| Non-Repetitive Peak Surge Current<br>(Surge applied at rated load conditions, halfwave, single phase, 60 Hz) | $I_{FSM}$                       | 100         | A                |
| Storage / Operating Case Temperature                                                                         | $T_{stg}, T_C$                  | - 65 to 150 | $^\circ\text{C}$ |
| Operating Junction Temperature                                                                               | $T_J$                           | - 65 to 150 | $^\circ\text{C}$ |

#### THERMAL CHARACTERISTICS

|                                          |                 |      |                    |
|------------------------------------------|-----------------|------|--------------------|
| Thermal Resistance — Junction-to-Case    | $R_{\theta JC}$ | 1.6  | $^\circ\text{C/W}$ |
| Thermal Resistance — Junction-to-Ambient | $R_{\theta JA}$ | 72.8 | $^\circ\text{C/W}$ |

#### ELECTRICAL CHARACTERISTICS

|                                                                                                                                                 |               |                          |                           |               |
|-------------------------------------------------------------------------------------------------------------------------------------------------|---------------|--------------------------|---------------------------|---------------|
| Maximum Instantaneous Forward Voltage (1) ( $I_F = 8.0 \text{ A}$ )<br><br><i>Typical</i>                                                       | $V_F$         | $T_J = 25^\circ\text{C}$ | $T_J = 150^\circ\text{C}$ | V             |
|                                                                                                                                                 |               | 1.7<br>1.4               | 1.3<br>1.1                |               |
| Maximum Instantaneous Reverse Current ( $V_R = 600 \text{ V}$ )<br><br><i>Typical</i>                                                           | $I_R$         | $T_J = 25^\circ\text{C}$ | $T_J = 150^\circ\text{C}$ | $\mu\text{A}$ |
|                                                                                                                                                 |               | 10<br>2.0                | 1000<br>80                |               |
| Maximum Reverse Recovery Time (2) ( $V_R = 400 \text{ V}$ , $I_F = 8.0 \text{ A}$ , $di/dt = 200 \text{ A}/\mu\text{s}$ )<br><br><i>Typical</i> | $t_{rr}$      | $T_J = 25^\circ\text{C}$ | $T_J = 125^\circ\text{C}$ | ns            |
|                                                                                                                                                 |               | 120<br>95                | 190<br>125                |               |
| Typical Recovery Softness Factor ( $V_R = 400 \text{ V}$ , $I_F = 8.0 \text{ A}$ , $di/dt = 200 \text{ A}/\mu\text{s}$ )                        | $s = t_b/t_a$ | 2.5                      | 3.0                       |               |
| Maximum Peak Reverse Recovery Current ( $V_R = 400 \text{ V}$ , $I_F = 8.0 \text{ A}$ , $di/dt = 200 \text{ A}/\mu\text{s}$ )                   | $I_{RRM}$     | 5.8                      | 8.3                       | A             |
| Maximum Reverse Recovery Charge ( $V_R = 400 \text{ V}$ , $I_F = 8.0 \text{ A}$ , $di/dt = 200 \text{ A}/\mu\text{s}$ )                         | $Q_{RR}$      | 350                      | 700                       | nC            |

(1) Pulse Test: Pulse Width  $\leq 380 \mu\text{s}$ , Duty Cycle  $\leq 2\%$

(2)  $T_{RR}$  measured projecting from 25% of  $I_{RRM}$  to zero current

Switchmode is a trademark of Motorola, Inc.

TYPICAL ELECTRICAL CHARACTERISTICS

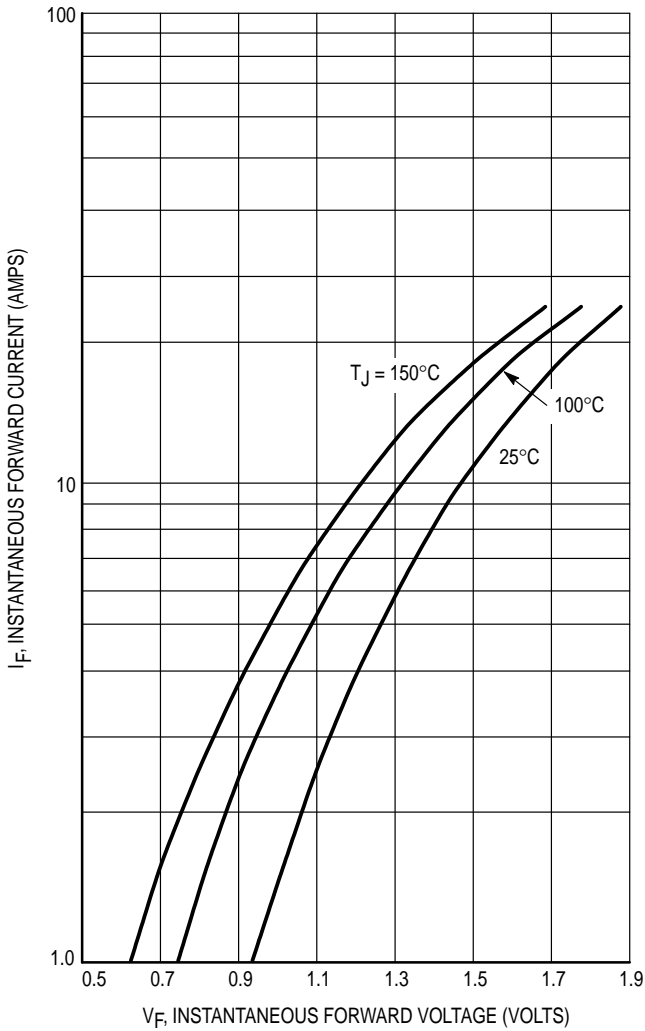


Figure 1. Typical Forward Voltage

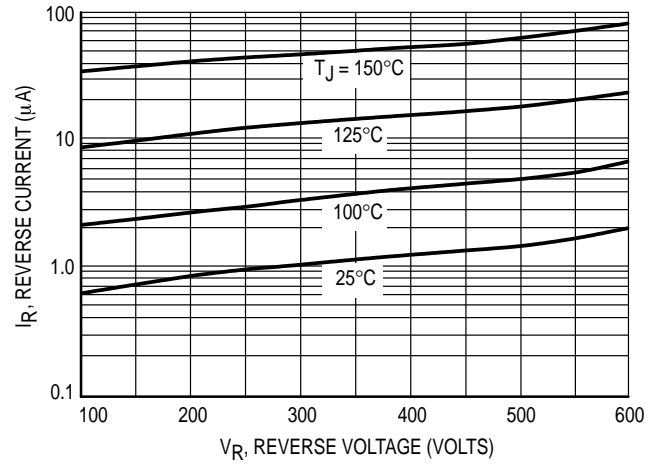


Figure 2. Typical Reverse Current

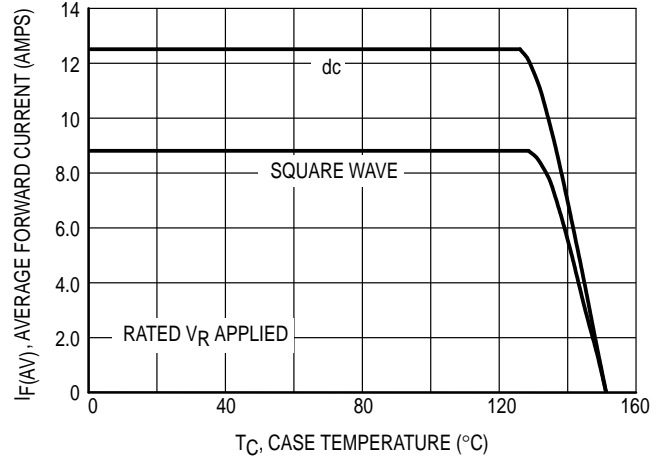


Figure 3. Current Derating, Case

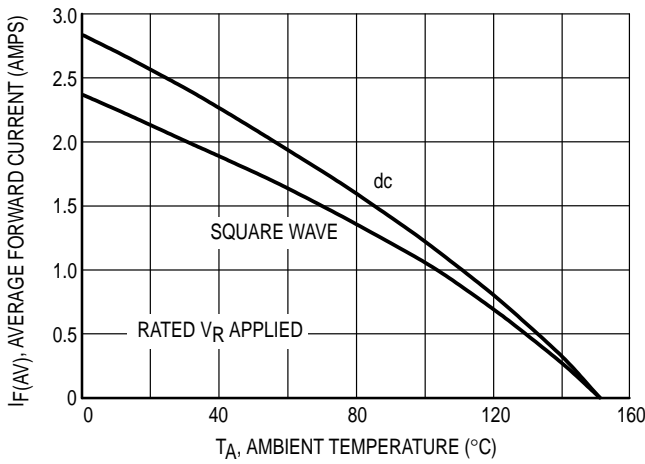


Figure 4. Current Derating, Ambient

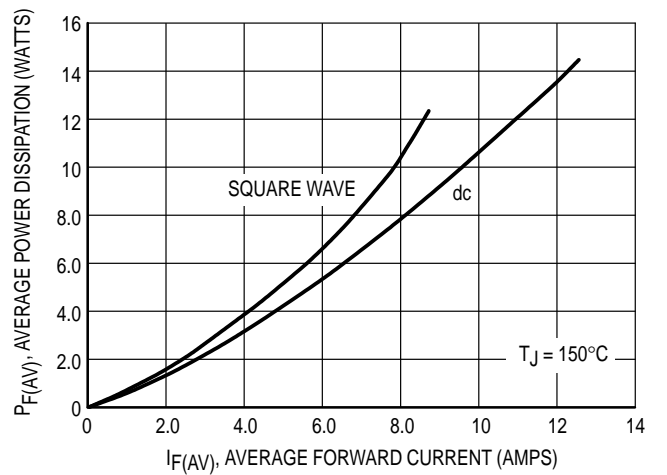


Figure 5. Power Dissipation

TYPICAL ELECTRICAL CHARACTERISTICS

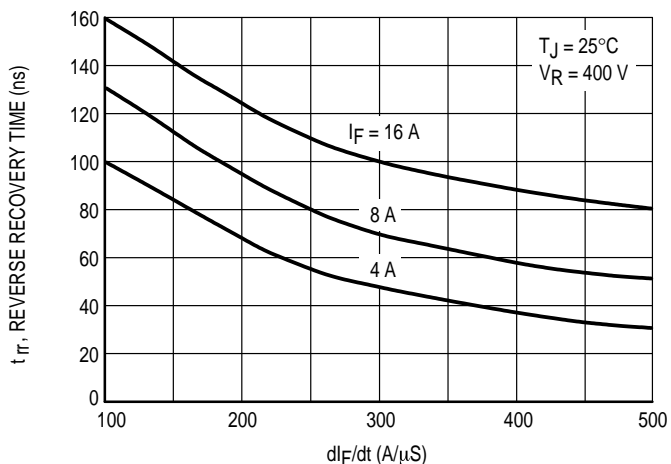


Figure 6. Typical Reverse Recovery Time

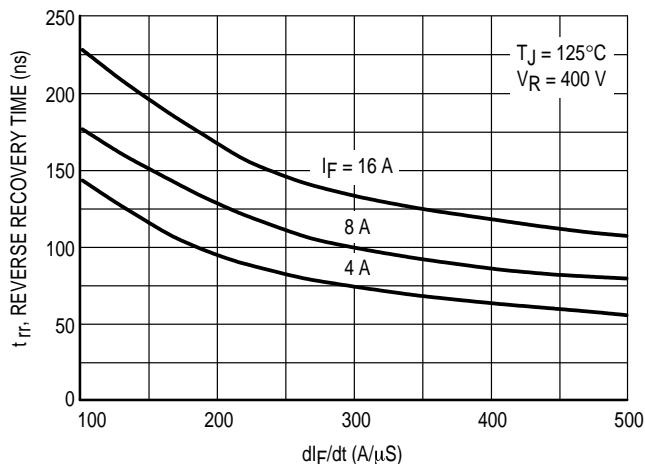


Figure 7. Typical Reverse Recovery Time

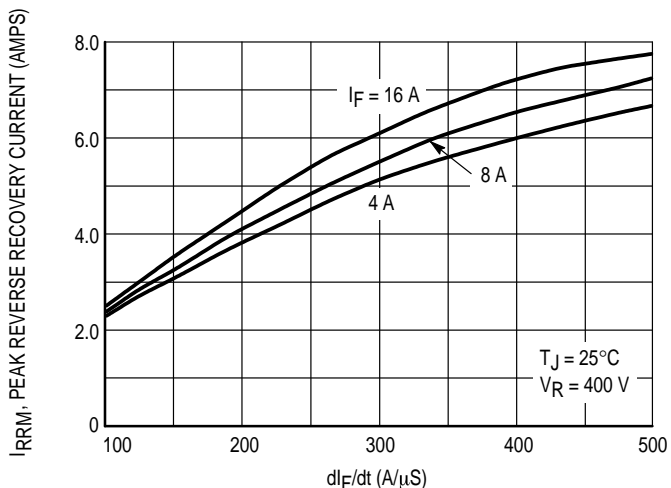


Figure 8. Typical Peak Reverse Recovery Current

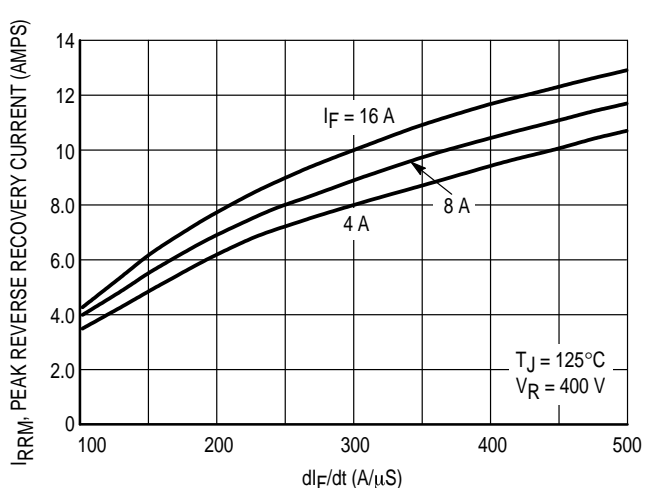


Figure 9. Typical Peak Reverse Recovery Current

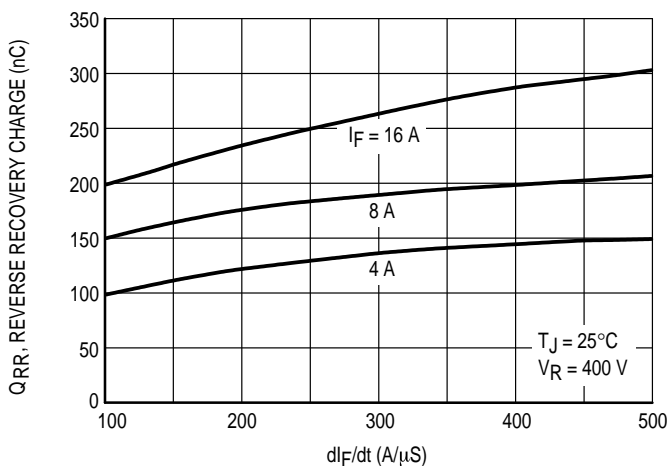


Figure 10. Typical Reverse Recovery Charge

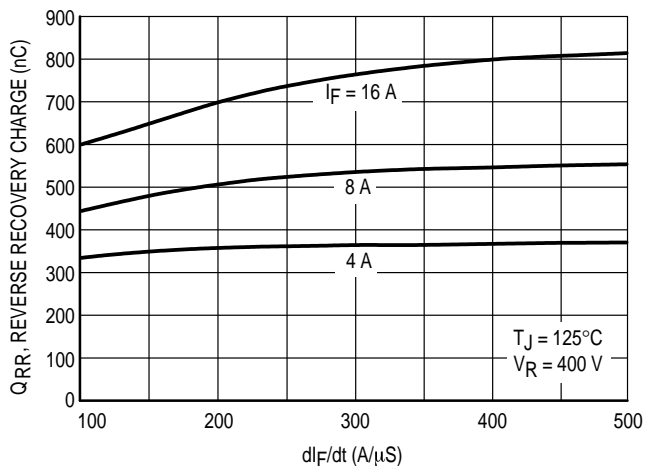
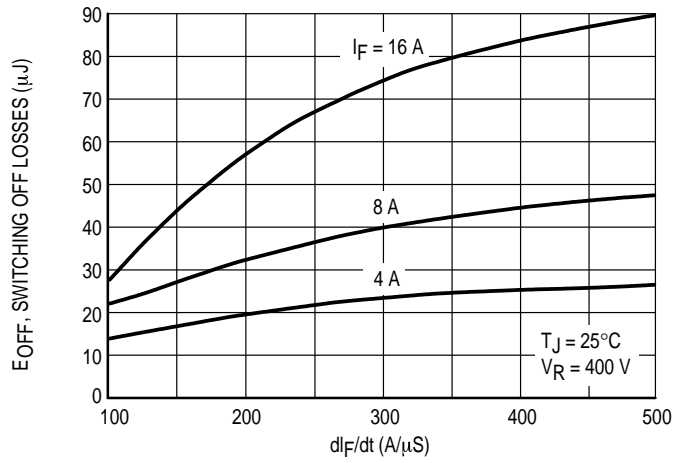
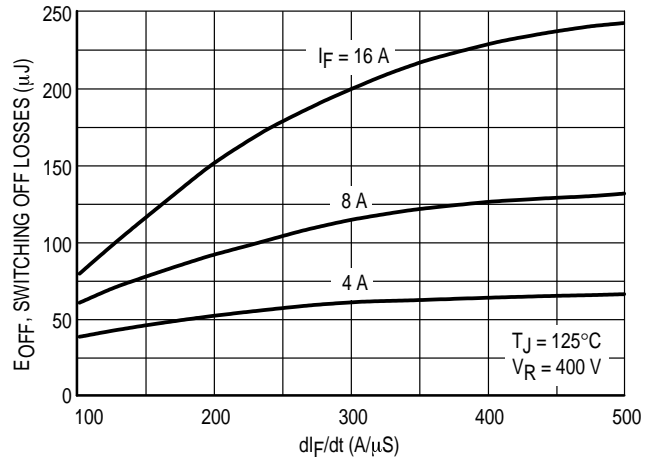


Figure 11. Typical Reverse Recovery Charge

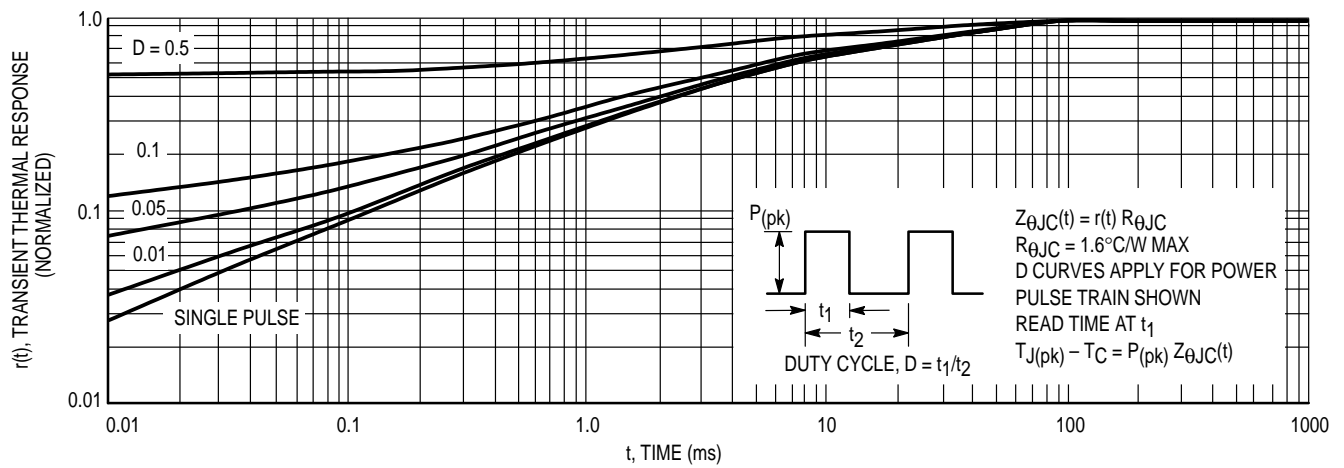
**MSR860**



**Figure 12. Typical Switching Off Losses**

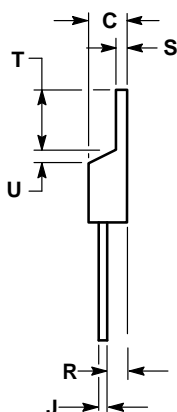
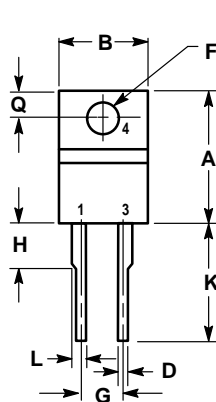


**Figure 13. Typical Switching Off Losses**



**Figure 14. Thermal Response**

## PACKAGE DIMENSIONS



## NOTES:

1. DIMENSIONING AND TOLERANCING PER ANSI Y14.5M, 1982.
2. CONTROLLING DIMENSION: INCH.

| DIM | INCHES |       | MILLIMETERS |       |
|-----|--------|-------|-------------|-------|
|     | MIN    | MAX   | MIN         | MAX   |
| A   | 0.595  | 0.620 | 15.11       | 15.75 |
| B   | 0.380  | 0.405 | 9.65        | 10.29 |
| C   | 0.160  | 0.190 | 4.06        | 4.82  |
| D   | 0.025  | 0.035 | 0.64        | 0.89  |
| F   | 0.142  | 0.147 | 3.61        | 3.73  |
| G   | 0.190  | 0.210 | 4.83        | 5.33  |
| H   | 0.110  | 0.130 | 2.79        | 3.30  |
| J   | 0.018  | 0.025 | 0.46        | 0.64  |
| K   | 0.500  | 0.562 | 12.70       | 14.27 |
| L   | 0.045  | 0.060 | 1.14        | 1.52  |
| Q   | 0.100  | 0.120 | 2.54        | 3.04  |
| R   | 0.080  | 0.110 | 2.04        | 2.79  |
| S   | 0.045  | 0.055 | 1.14        | 1.39  |
| T   | 0.235  | 0.255 | 5.97        | 6.48  |
| U   | 0.000  | 0.050 | 0.00        | 1.27  |

## STYLE 1:

1. CATHODE
2. N/A
3. ANODE
4. CATHODE

**CASE 221B-03  
ISSUE B**

Motorola reserves the right to make changes without further notice to any products herein. Motorola makes no warranty, representation or guarantee regarding the suitability of its products for any particular purpose, nor does Motorola assume any liability arising out of the application or use of any product or circuit, and specifically disclaims any and all liability, including without limitation consequential or incidental damages. "Typical" parameters which may be provided in Motorola data sheets and/or specifications can and do vary in different applications and actual performance may vary over time. All operating parameters, including "Typicals" must be validated for each customer application by customer's technical experts. Motorola does not convey any license under its patent rights nor the rights of others. Motorola products are not designed, intended, or authorized for use as components in systems intended for surgical implant into the body, or other applications intended to support or sustain life, or for any other application in which the failure of the Motorola product could create a situation where personal injury or death may occur. Should Buyer purchase or use Motorola products for any such unintended or unauthorized application, Buyer shall indemnify and hold Motorola and its officers, employees, subsidiaries, affiliates, and distributors harmless against all claims, costs, damages, and expenses, and reasonable attorney fees arising out of, directly or indirectly, any claim of personal injury or death associated with such unintended or unauthorized use, even if such claim alleges that Motorola was negligent regarding the design or manufacture of the part. Motorola and  are registered trademarks of Motorola, Inc. Motorola, Inc. is an Equal Opportunity/Affirmative Action Employer.

Mfax is a trademark of Motorola, Inc.

**How to reach us:**

**USA/EUROPE/Locations Not Listed:** Motorola Literature Distribution;  
P.O. Box 5405, Denver, Colorado 80217. 303-675-2140 or 1-800-441-2447

**JAPAN:** Nippon Motorola Ltd.; Tatsumi-SPD-JLDC, 6F Seibu-Butsuryu-Center,  
3-14-2 Tatsumi Koto-Ku, Tokyo 135, Japan. 81-3-3521-8315

**Mfax™:** RMFAX0@email.sps.mot.com – TOUCHTONE 602-244-6609  
**INTERNET:** <http://Design-NET.com>

**ASIA/PACIFIC:** Motorola Semiconductors H.K. Ltd.; 8B Tai Ping Industrial Park,  
51 Ting Kok Road, Tai Po, N.T., Hong Kong. 852-26629298

**MOTOROLA**