

OLIMEXINO-STM32 development board Users Manual



All boards produced by Olimex are ROHS compliant

Revision B, October 2011
Designed by OLIMEX Ltd, 2011

INTRODUCTION:

What is Arduino?

Arduino is an open-source electronics prototyping platform, designed to make the process of using electronics in multidisciplinary projects more accessible. The hardware consists of a simple open hardware design for the Arduino board with an Atmel AVR processor and on-board I/O support. The software consists of a standard programming language and the boot loader that runs on the board.

Arduino hardware is programmed using a Wiring-based language (syntax + libraries), similar to C++ with some simplifications and modifications, and a Processing-based IDE.

The project began in Ivrea, Italy in 2005 to make a device for controlling student-built interaction design projects less expensively than other prototyping systems available at the time. As of February 2010 more than 120,000 Arduino boards had been shipped. Founders Massimo Banzi and David Cuartielles named the project after a local bar named Arduino. The name is an Italian masculine first name, meaning "strong friend". The English pronunciation is "Hardwin", a namesake of Arduino of Ivrea

More information could be found at the creators web page <http://arduino.cc/> and in the Arduino Wiki <http://en.wikipedia.org/wiki/Arduino>

To make the story short - Arduino is easy for the beginners with lack of Electronics knowledge, but also do not restrict the professionals as they can program it in C++ or mix of Arduino/C++ language.

There are thousands of projects which makes the startup easy as there is barely no field where Arduino enthusiasts to have not been already.

Arduino has inspired two other major derivatives - MAPLE and PINGUINO. Based on 8-bit AVR technology the computational power of Arduino boards are modest, this is why team from MIT developed **MAPLE** project which is based on ARM7 STM32F103RBT6 microcontroller, the board have same friendly IDE as Arduino and offers the same capabilities as hardware and software but runs the Arduino code much faster. Maple project can be found at <http://leaflabs.com>

BOARD FEATURES:

We enter in Arduino/MAPLE field 5 years after the design was introduced, and this allowed us to see and skip all the errors the Arduino inventors did :-)

We had the possibility to read current customer feedback and to implement what they wanted to see in the original Arduino.

1. Original Arduino/MAPLE uses linear power supply, this limits the input voltage range. We designed the power supply to accept power from 9 to 30V DC thus making possible to take virtually any power supply adapter on the market, also enable application which are in industrial power supply 24VDC.
2. We carefully selected all components to work reliable in **INDUSTIRAL temperature range -25+85C** so the board can be used in INDUSTIRAL applications while the original design is to Commercial 0-70C operating temperature.
3. The original Arduino/MAPLE design is not good for portable applications as consumes too much power with the linear vltage regulators, we put ULTRA LOW POWER voltage regulators and the consumption is only few microamps, which enables handheld and battery powered applications.
4. We add Li-Ion rechargeable battery power supply option with BUILD-IN on board charger, so when you attach battery it is automatically charged and kept in this state until the other power source (USB or external adapter) is removed and it AUTOMATICALLY will power the board - no jumpers, no switches!
5. Our board have UEXT connector which allow many existing modules like RF, ZIGBEE, GSM, GPS to be connected.
6. Our board have SD-MMC card
7. Our board have CAN driver on board
8. Our desing allow RTC - Real Time Clock.
9. We made our design noise immune.
10. We use separate voltage regulator for the Analog part, which allow the ADC to be read correctly without the digital noise pickup.
11. Optionally if someone need higher precision and temperature stability in Analog reading we have provision on the board for Aref preciese source.
12. The LEDs and the BUTTONs are on the edge of the board so there is easy access even if the boards have shields on them.
13. All components are LOWER than the connectors, so the shields do not interference with them.
14. mini USB connector is used which is common and used in most cell phones, so you do not have to buy other cables
15. Original Arduino design had flaw and the connectors were not spaced at 0.1" this make perfo board use impossible, to keep the compatibility we have same spacing but we add next to this connector on 0.1" which customer can use with perforated boards.

16. All signals on the connectors are printed on top and on bottom of the board, so when you check with probe you know exactly which port you are measuring.
17. 4 mount holes make board attachment easier

ELECTROSTATIC WARNING:

The OLIMEXINO-STM32 board is shipped in protective anti-static packaging. The board must not be subject to high electrostatic potentials. General practice for working with static sensitive devices should be applied when working with this board.

BOARD USE REQUIREMENTS:

Cables: You'll need mini USB cable for connecting the board to PC. For programming - the cable you will need depends on the programmer/debugger you use. If you use ARM-JTAG-EW, ARM-USB-TINY or ARM-USB-TINY-H, you will need USB A-B cable, if you use ARM-USB-OCD or ARM-USB-OCD-H, you will need USB A-B cable and RS232 cable.

Hardware: Programmer/Debugger [ARM-USB-OCD](#), [ARM-USB-OCD-H](#), [ARM-USB-TINY](#), [ARM-USB-TINY-H](#), [ARM-JTAG-EW](#) or other compatible programming/debugging tool if you work with EW-ARM. You will also need ARM-JTAG-20-10 adapter for programming the board.

SCHEMATIC:

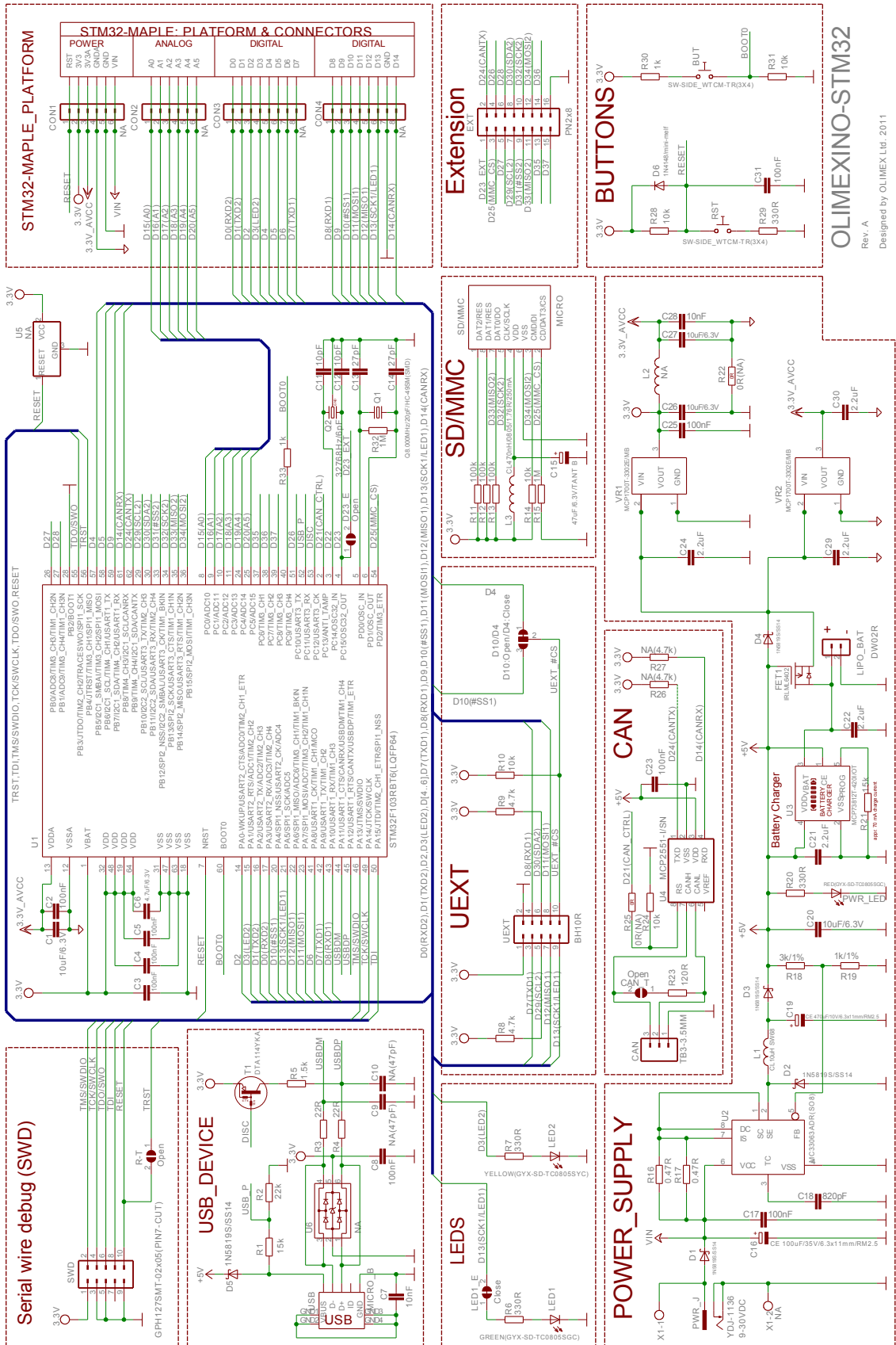

OLIMEXINO-STM32

Rev. A
Designed by OLIMEX Ltd. 2011
<http://www.olimex.com/dev>

BOARD LAYOUT:

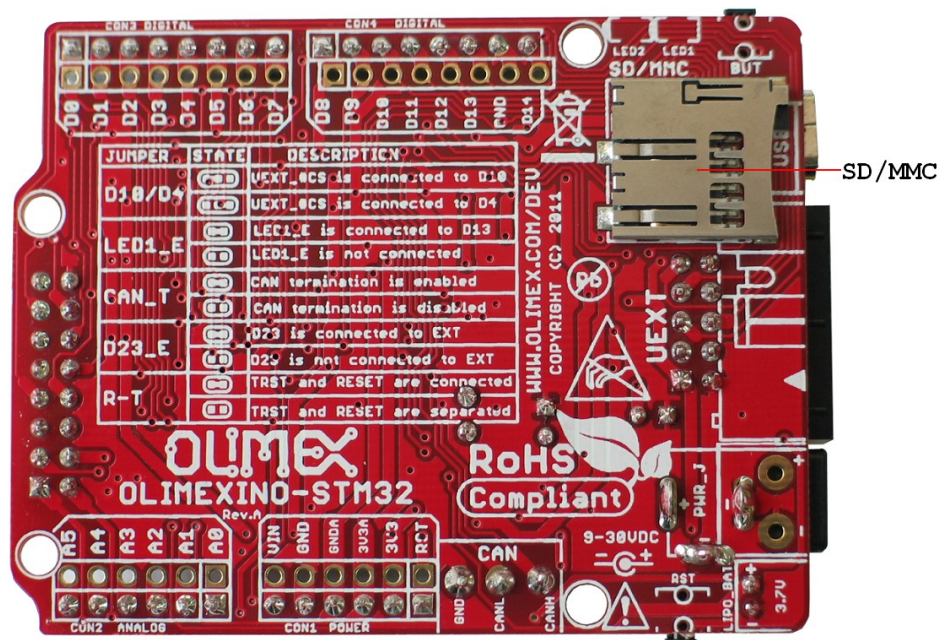
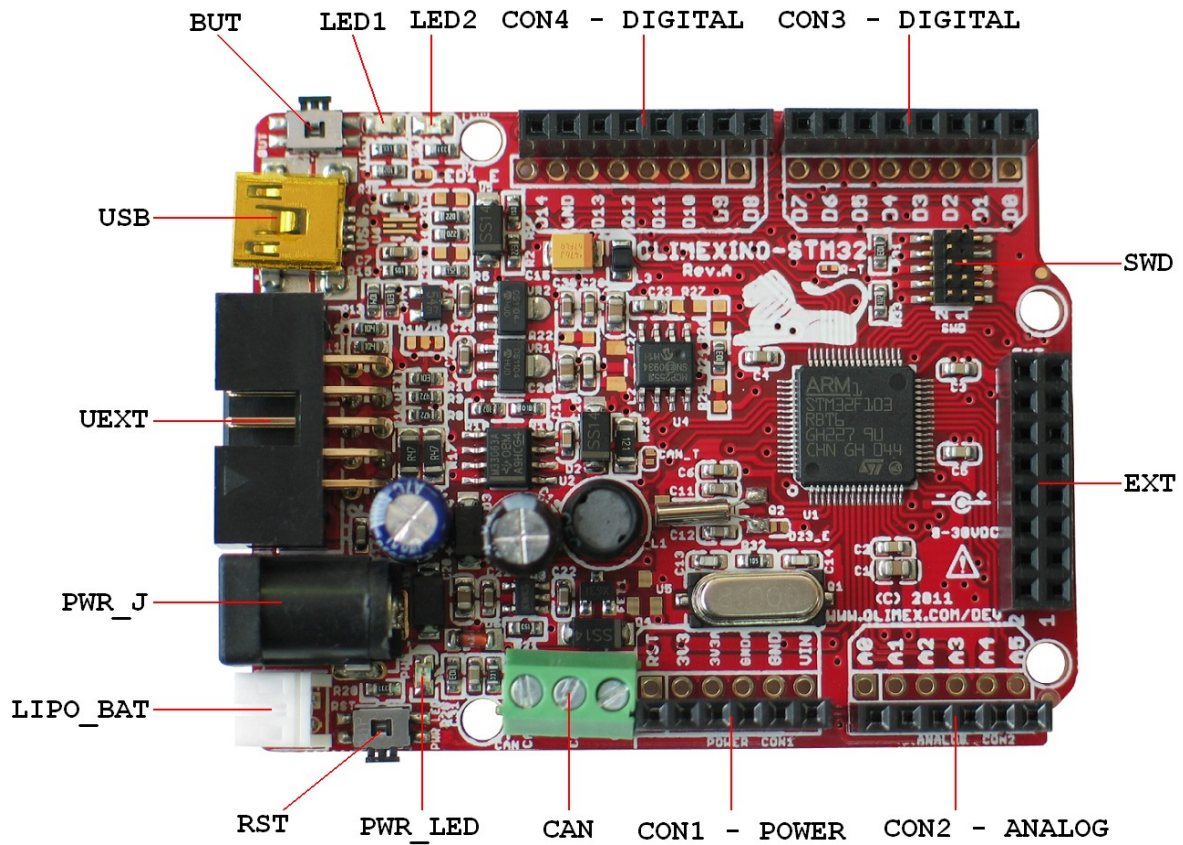

POWER SUPPLY CIRCUIT:

OLIMEXINO-STM32 can take power supply from:

- external power supply (9-30) VDC.
- + 5V from USB
- 3.7 V Li-ion battery

The programmed board power consumption is about 50 mA with all peripherals enabled

RESET CIRCUIT:

OLIMEXINO-STM32 reset circuit includes D6 (1N4148), R28 (10k Ω), R29 (330 Ω), C31 (100nF), STM32F103RBT6 pin 7 (NRST) and RESET button.

CLOCK CIRCUIT:

Quartz crystal **Q1** 8 MHz is connected to STM32F103RBT6 pin 5 (PD0/OSC_IN) and pin 6 (PD1/OSC_OUT).

Quartz crystal **Q2** 32.768 kHz is connected to STM32F103RBT6 pin 3 (PC14/OSC32_IN) and pin 4 (PC15/OSC32_OUT).

JUMPER DESCRIPTION:

LED1_E



This jumper, when is closed, enables LED1.

Default state is closed.

D23_E



This jumper, when is closed, connects STM32F103RBT6 pin (PC15/OSC32_OUT) - signal D23 to EXT pin 1, and when is opened, D23 is not connected to EXT.

Default state is opened.

R-T



This jumper, when is closed, connects TRST and RESET, and when is opened, TRST and RESET are separated.

Default state is opened.

CAN_T



This jumper, when is closed, CAN termination is enabled, and when is opened, CAN termination is disabled.

Default state is opened.

D10/D4



when

This jumper, when is in position D10, UEXT pin 10 (UEXT_#CS) is connected to STM32F103RBT6 pin 20 (PA4/SPI1_NSS/USART2_CK/ADC4) – signal D10, and is in position D4, UEXT pin 10 (UEXT_#CS) is connected to STM32F103RBT6 pin 57 (PB5/I2C1_SMBAI/TIM3_CH2/SPI1_MOSI) – signal D4.

Default state is in position D4.

INPUT/OUTPUT:

Status Led with name **LED1 (green)** connected via jumper LED1_E to STM32F103RBT6 pin 21 (PA5/SPI1_SCK/ADC5) – signal D13(SCK/LED1).

Status Led with name **LED2 (yellow)** connected to STM32F103RBT6 pin 15 (PA1/USART2_RTS/ADC1/TIM2_CH2) – signal D3(LED2).

Power-on LED (red) with name **PWR_LED** – this LED shows that the board is power supplied.

User button with name **BUT** connected to **STM32F103RBT6** pin 40 (PC9/TIM3_CH4) via R33 (1kΩ) and pin 60 (BOOT0) – signal BOOT0.

User button with name **RST** connected to STM32F103RBT6 pin 7 (NRST).

EXTERNAL CONNECTORS DESCRIPTION:

SWD:

Pin #	Signal Name
1	VCC
2	TMS/SWDIO
3	GND
4	TCK/SWCLK
5	GND
6	TDO/SWO
7	Cut off
8	TDI
9	GND
10	RESET

Note that pin 7 of SWD connector is cut off.

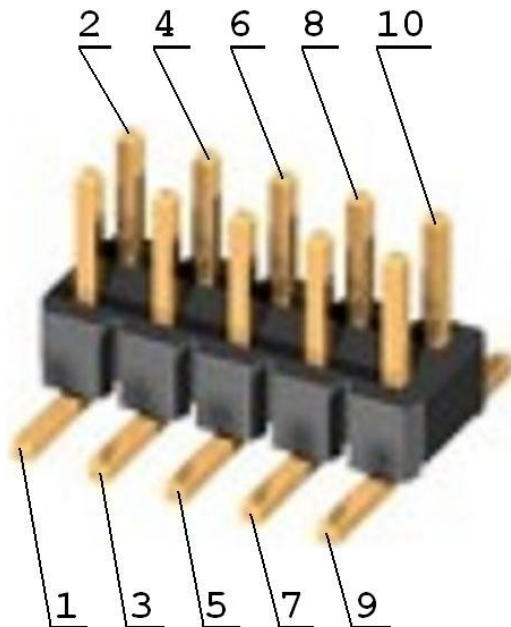

UEXT:

Pin #	Signal Name
1	VCC
2	GND
3	D7(TXD1)
4	D8(RXD1)
5	D29(SCL2)
6	D30(SDA2)
7	D12(MISO1)
8	D11(MOSI1)
9	D13(SCK/LED1)D13(SCK1/LED1)
10	UEXT_#CS

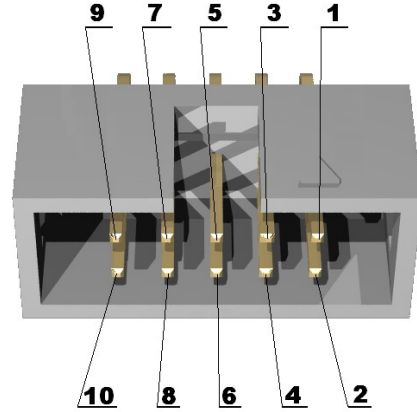

PWR JACK:

Pin #	Signal Name
1	Power Input
2	GND

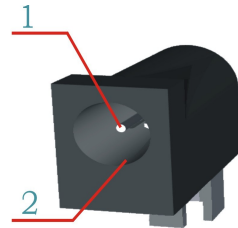

CON1 - POWER:

Pin #	Signal Name
1	RESET
2	VCC (3V3)
3	VDD (3V3A)
4	GND
5	GND
6	VIN

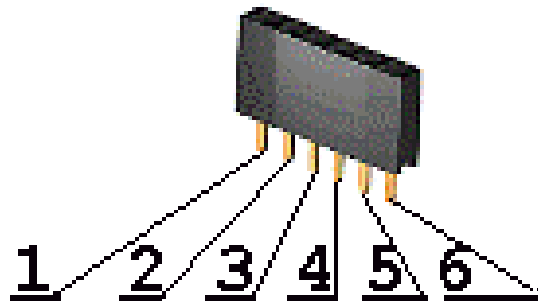

CON2 - ANALOG:

Pin #	Signal Name
1	D15(A0)
2	D16(A1)
3	D17(A2)
4	D18(A3)
5	D19(A4)
6	D20(A5)

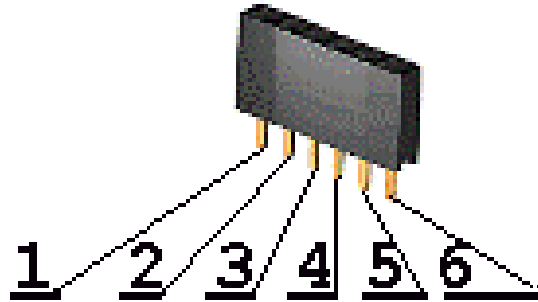

CON3 - DIGITAL:

Pin #	Signal Name
1	D0(RXD2)
2	D1(TXD2)
3	D2
4	D3(LED2)
5	D4
6	D5
7	D6
8	D7(TXD1)

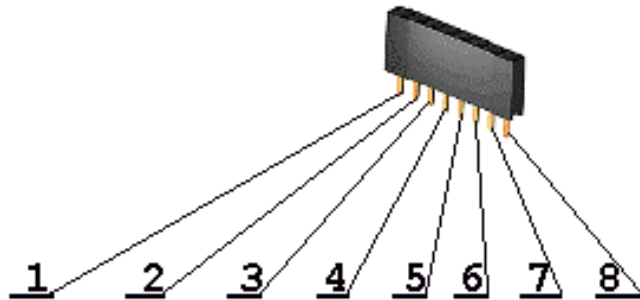

CON4 - DIGITAL:

Pin #	Signal Name
1	D8(RXD1)
2	D9
3	D10(#SS1)
4	D11(MOSI1)
5	D12(MISO1)
6	D13(SCK/LED1) D13(SCK1/LED1)
7	GND
8	D14(CANRX)

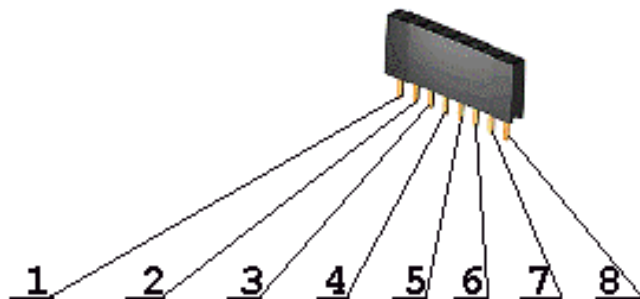

LI BAT:

Pin #	Signal Name
1	VBAT
2	GND

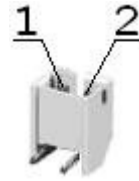

USB:

Pin #	Signal Name
1	+5V_USB
2	D -
3	D +
4	Not connected
5	GND

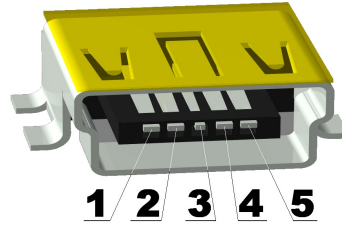

SD/MMC:

Pin #	Signal Name
1	MCIDAT2
2	D25(MMC_CS)
3	D34(MOSI2)
4	MMC_PWR
5	D32(SCK2)
6	GND
7	D33(MISO2)
8	MCIDAT1
9	Not connected
10	Not connected
11	Not connected
12	Not connected

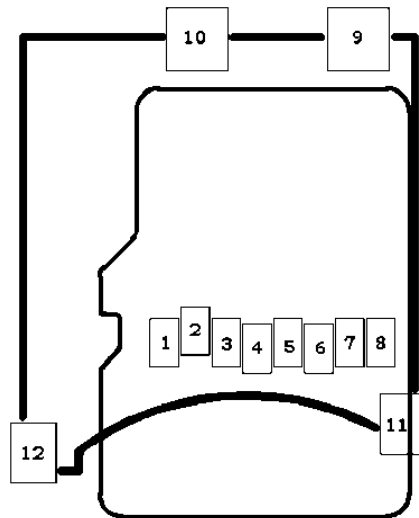

EXT:

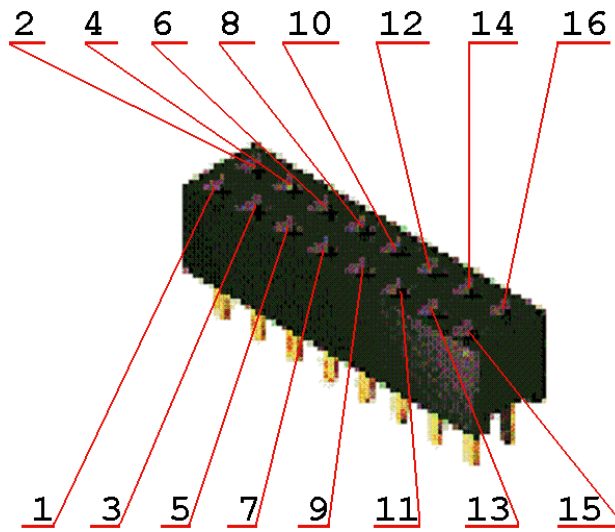

Pin #	Signal Name	Pin #	Signal Name
1	D23_EXT	2	D24(CANTX)
3	D25(MMC_CS)	4	D26
5	D27	6	D28
7	D29(SCL2)	8	D30(SDA2)
9	D31(#SS2)	10	D32(SCK2)
11	D33(MISO2)	12	D34(MOSI2)
13	D35	14	D36
15	D37	16	GND

CAN:

Pin #	Signal Name
1	GND
2	CANL
3	CANH



MECHANICAL DIMENSIONS:

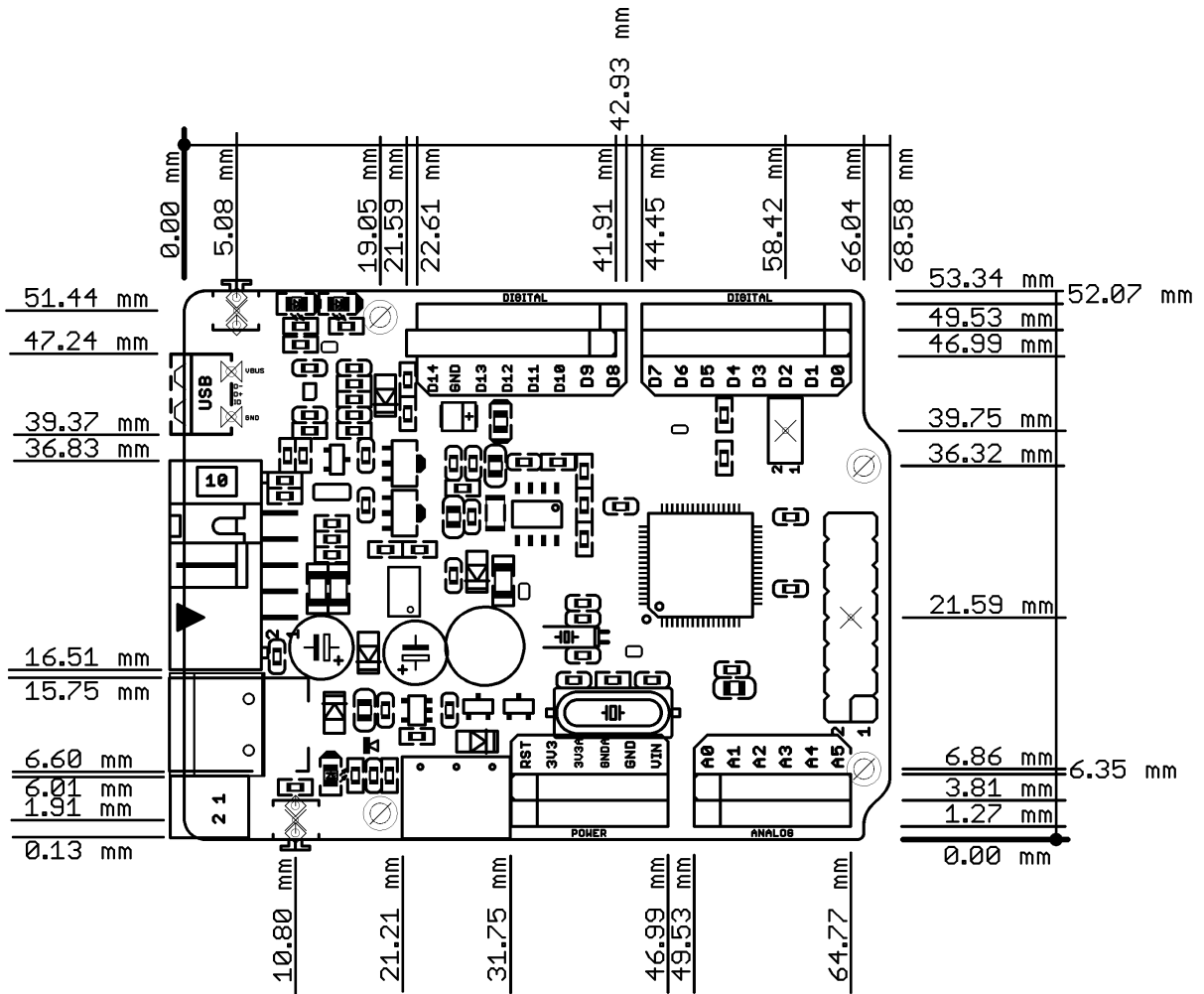

AVAILABLE DEMO SOFTWARE:

- The software consists of boot loader that runs on the board and a simple blinking led project.

ORDER CODE:

OLIMEXINO-STM32 - assembled and tested board

How to order?

You can order to us directly or by any of our distributors.
Check our web www.olimex.com/dev for more info.

Revision history:

Board's revision	Rev. A, April 2011
Manual's revision	Rev. A, August 2011 - At first page "Copyright(c) 2011, OLIMEX Ltd, All rights reserved" is replaces with "Designed by OLIMEX Ltd., 2011" - In schematic "COPYRIGHT(C) 2011, OLIMEX Ltd." replaced with "DESIGNED BY OLIMEX LTD, 2011"
	Rev. B, October 2011 - in schematic - C6 (100nF) is replaced with 4.7 μ F

Disclaimer:

© 2011 Olimex Ltd. Olimex®, logo and combinations thereof, are registered trademarks of Olimex Ltd. Other terms and product names may be trademarks of others.

The information in this document is provided in connection with Olimex products. No license, express or implied or otherwise, to any intellectual property right is granted by this document or in connection with the sale of Olimex products.

Neither the whole nor any part of the information contained in or the product described in this document may be adapted or reproduced in any material from except with the prior written permission of the copyright holder.

The product described in this document is subject to continuous development and improvements. All particulars of the product and its use contained in this document are given by OLIMEX in good faith. However all warranties implied or expressed including but not limited to implied warranties of merchantability or fitness for purpose are excluded.

This document is intended only to assist the reader in the use of the product. OLIMEX Ltd. shall not be liable for any loss or damage arising from the use of any information in this document or any error or omission in such information or any incorrect use of the product.