

### PROTECTION PRODUCTS

#### Description

RClamp® TVS diodes are designed to protect sensitive electronics from damage or latch-up due to transient surge events. This device offers desirable characteristics for board level protection including fast response time, low operating and clamping voltage, and no device degradation.

RClamp®0504FB features extremely good ESD and EOS protection characteristics highlighted by low dynamic resistance and high surge capability. Data (I/O) lines are protected from EOS surge events as high as 14A ( $t_p = 8/20\mu s$ ). Power buses may be subjected to even harsher EOS events. The TVS connection at pin 5 allows protection of VBus lines to 28A ( $t_p = 8/20\mu s$ ).

RClamp0504FB is in a 6-pin, SC-70 6L package. The leads are finished with lead-free matte tin. The combination of small size, low capacitance, and high ESD and EOS surge capability makes them ideal for use in applications such as USB 2.0, multimedia cards, and video interfaces.

#### Features

- High ESD withstand Voltage: +/-24kV (Contact) & +/-30kV (Air) per IEC 61000-4-2
- High EOS Surge capability
- Low ESD clamping voltage
- Working voltage: 5V
- Low capacitance: 1.1 pF Typical (I/O to GND)
- Low dynamic resistance:  $0.25\Omega$
- Solid-state silicon-avalanche technology

#### Mechanical Characteristics

- SC-70 6L package
- Pb-Free, Halogen Free, RoHS/WEEE compliant
- Nominal Dimensions: 1.0 x 0.6 x 0.50 mm
- Lead Finish: Matte Tin
- Marking: Marking code
- Packaging: Tape and Reel

#### Applications

- Monitors and Flat Panel Displays
- Analog Video Lines
- LVDS Lines
- USB 2.0 / USB 3.0
- SIM Ports

#### Circuit Diagram

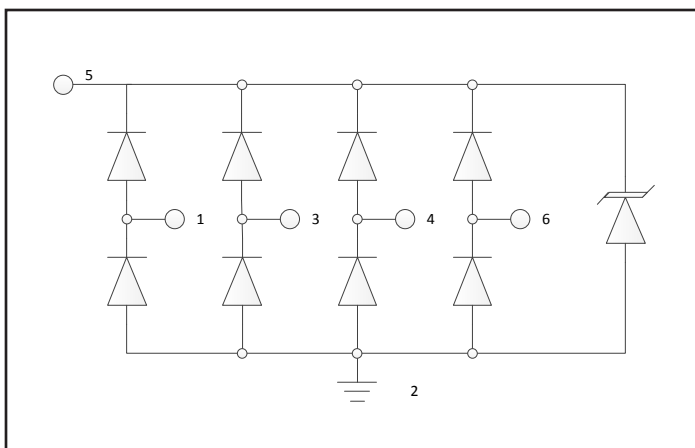

#### Schematic & Pin Configuration

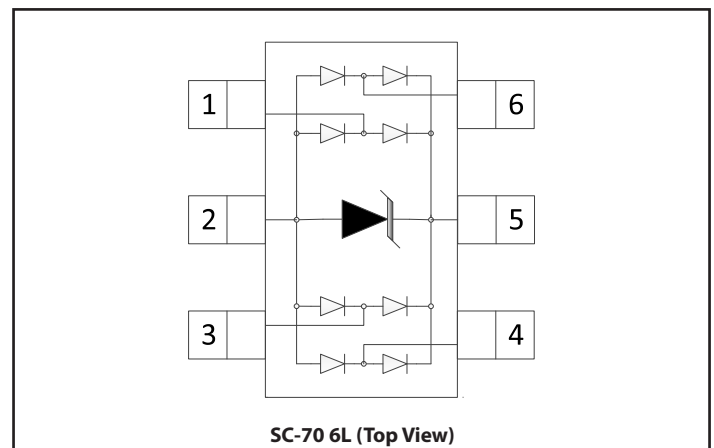

## Absolute Maximum Rating

| Rating   | Symbol    | Value                | Units |
|--|-----------|----------------------|-------|
| Peak Pulse Power (I/O Pins, $t_p = 8/20\mu s$ )  | $P_{PK}$  | 230                  | W     |
| Peak Pulse Power (VBus Pin, $t_p = 8/20\mu s$ )  | $P_{PK}$  | 500                  | W     |
| Peak Pulse Current (I/O Pins, $t_p = 8/20\mu s$ )  | $I_{PP}$  | 14                   | A     |
| Peak Pulse Current (VBus Pin, $t_p = 8/20\mu s$ )  | $I_{PP}$  | 28                   | A     |
| ESD per IEC 61000-4-2 (Air) <sup>(1)</sup><br>ESD per IEC 61000-4-2 (Contact) <sup>(1)</sup> | $V_{ESD}$ | $\pm 30$<br>$\pm 24$ | kV    |
| Operating Temperature  | $T_J$     | -55 to +125          | °C    |
| Storage Temperature  | $T_{STG}$ | -55 to +150          | °C    |

## Electrical Characteristics (T=25°C unless otherwise specified)

| Parameter                         | Symbol    | Conditions                                  | Min.                 | Typ. | Max. | Units    |    |
|-----------------------------------|-----------|---|----------------------|------|------|----------|----|
| Reverse Stand-Off Voltage         | $V_{RWM}$ | Any pin to Pin 2                            |                      |      | 5    | V        |    |
| Reverse Breakdown Voltage         | $V_{BR}$  | $I_{BR} = 1mA$ , any I/O Pin to Pin 2       | 6                    | 8.5  | 10   | V        |    |
| Reverse Leakage Current           | $I_R$     | $V_{RWM} = 5V$ , any I/O Pin to Pin 2       |                      |      | 0.1  | $\mu A$  |    |
| Clamping Voltage                  | $V_C$     | $t_p = 8/20\mu s$<br>(Any I/O Pin to Pin 2) | $I_{PP} = 14A$       |      | 13.7 | 16.5     | V  |
|                                   |           | $t_p = 8/20\mu s$<br>(Pin 5 to Pin 2)       | $I_{PP} = 28A$       |      | 15.5 | 17.5     |    |
| ESD Clamping Voltage <sup>2</sup> | $V_C$     | $t_p = 0.2/100ns$<br>(Any I/O Pin to Pin 2) | $I_{PP} = 4A$        |      | 10.5 |          | V  |
|                                   |           |   | $I_{PP} = 16A$       |      | 13.5 |          |    |
| Dynamic Resistance <sup>2,3</sup> | $R_{DYN}$ | $t_p = 0.2/100ns$ , Any I/O Pin to Pin 2    |                      | 0.25 |      | $\Omega$ |    |
| Junction Capacitance              | $C_J$     | $V_R = 0V$ , $f = 1MHz$                     | Any I/O Pin to Pin 2 |      | 1.1  | 2.5      | pF |
|                                   |           |   | Between I/O pins     |      | 0.55 | 1.5      |    |

### Notes

- 1) Measured with a 40dB attenuator, 50 Ohm scope input impedance, 2GHz bandwidth. ESD gun return path connected to ESD ground plane.
- 2) Transmission Line Pulse Test (TLP) Settings:  $t_p = 100ns$ ,  $t_r = 0.2ns$ ,  $I_{TLP}$  and  $V_{TLP}$  averaging window:  $t_1 = 70ns$  to  $t_2 = 90ns$ .
- 3) Dynamic resistance calculated from  $I_{TLP} = 4A$  to  $I_{TLP} = 16A$

# Typical Characteristics

**Non Repetitive Peak Pulse Power vs. Pulse Time**

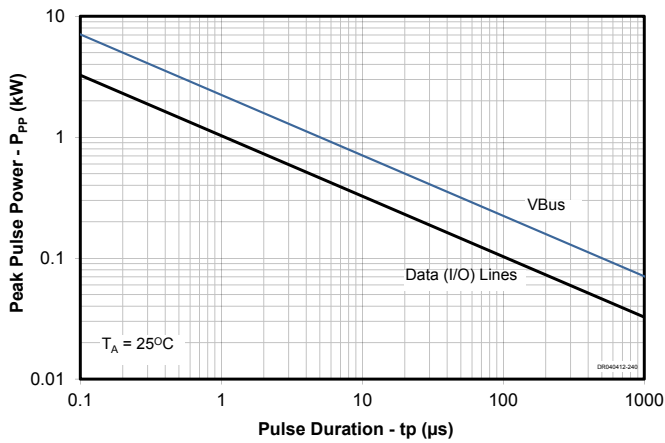

**Power Derating Curve**

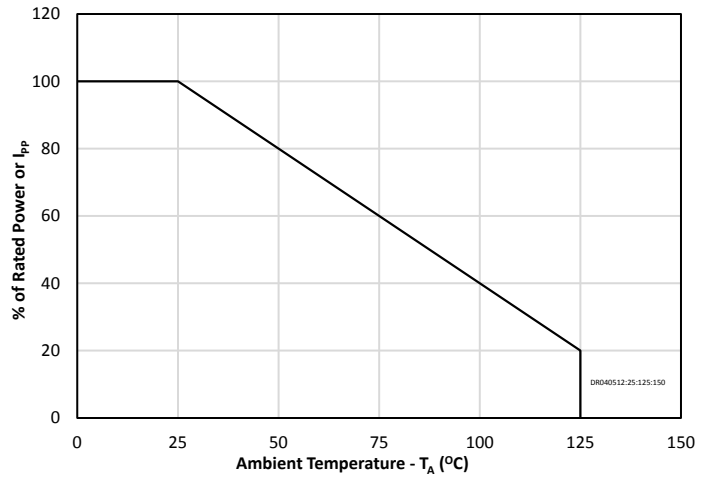

**Clamping Voltage vs. Peak Pulse Current ( $t_p=8/20\mu s$ )**

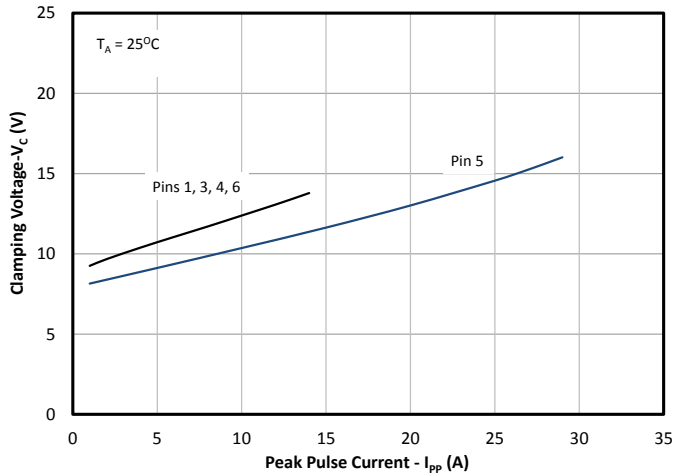

**Capacitance vs. Reverse Voltage (Pins 1, 3, 4, 6 to Pin 2)**

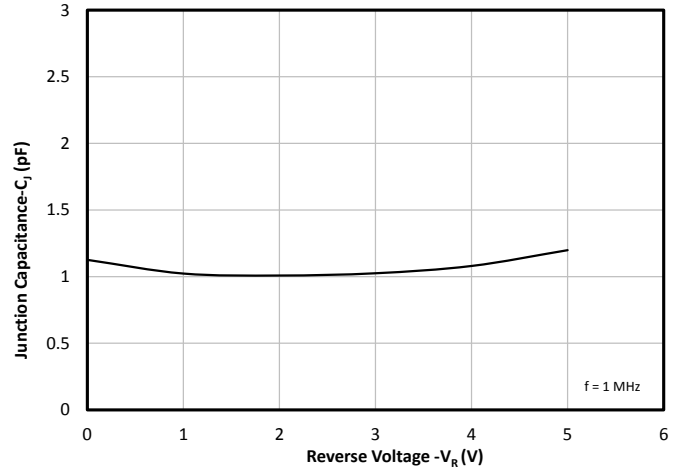

**ESD Clamping (8kV Contact per IEC 61000-4-2) (Pins 1, 3, 4, 6)**

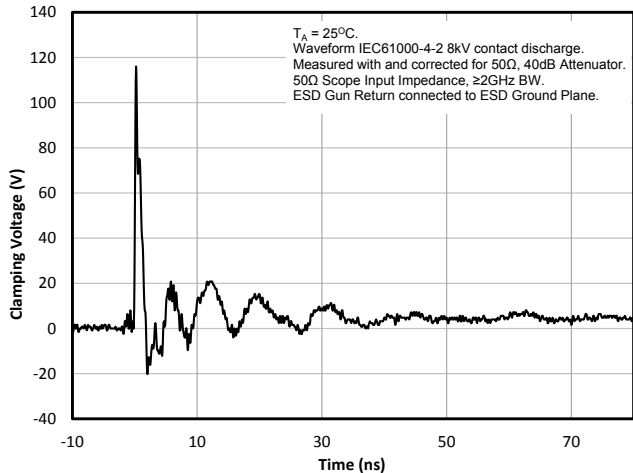

**ESD Clamping (-8kV Contact per IEC 61000-4-2) (Pins 1, 3, 4, 6)**

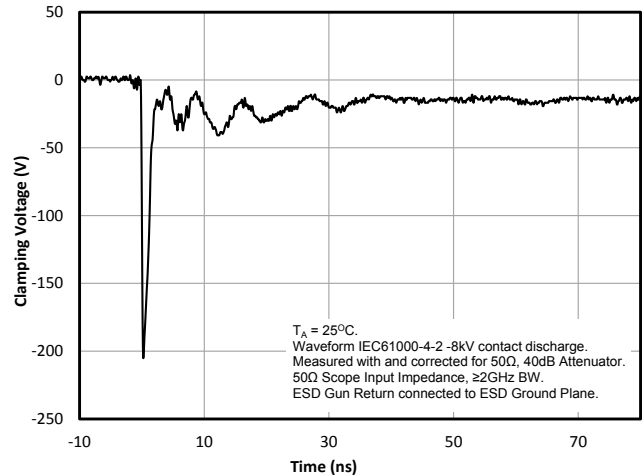

# Typical Characteristics (Continued)

**Positive TLP Characteristic (Pins 1, 3, 4, 6)**

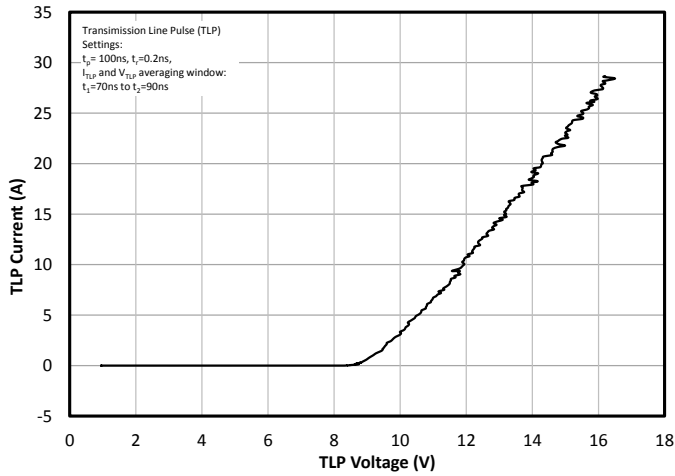

**Negative TLP Characteristic (Pins 1, 3, 4, 6)**

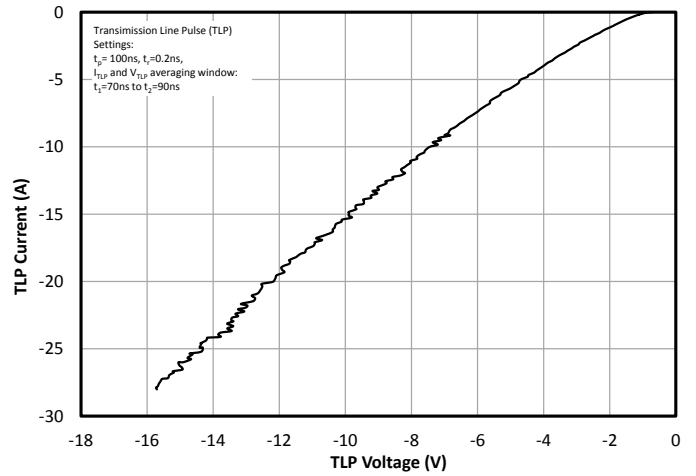

**Insertion Loss (I/O Pins 1, 3, 4, 6)**

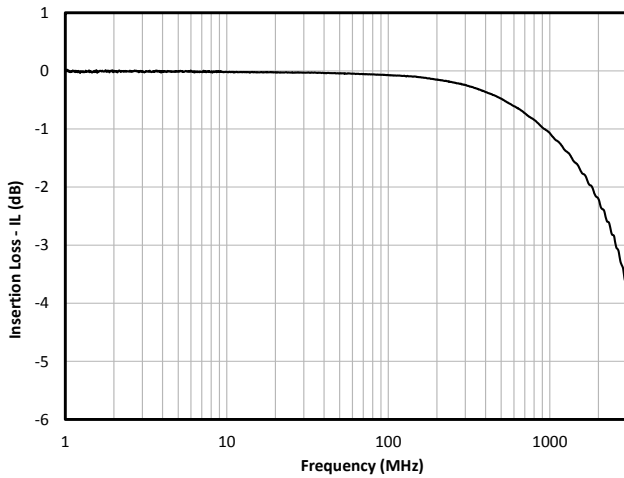

**Insertion Loss (I/O Pin to I/O Pin)**

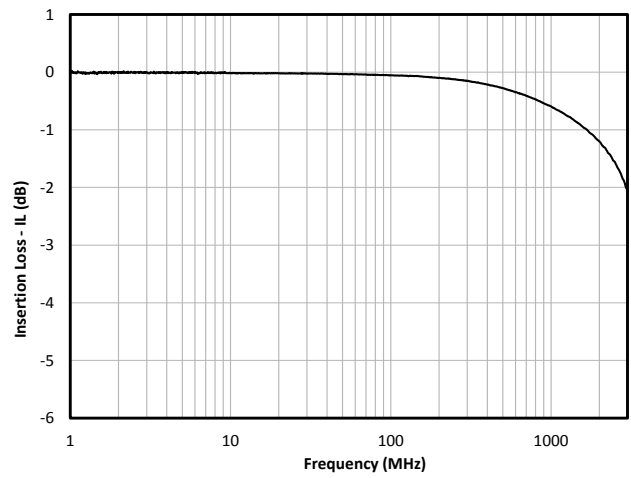

**Analog Crosstalk**

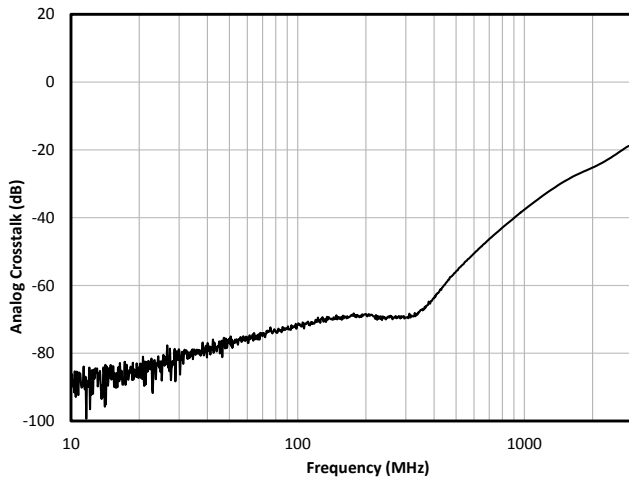

# Outline Drawing - SC70 6L

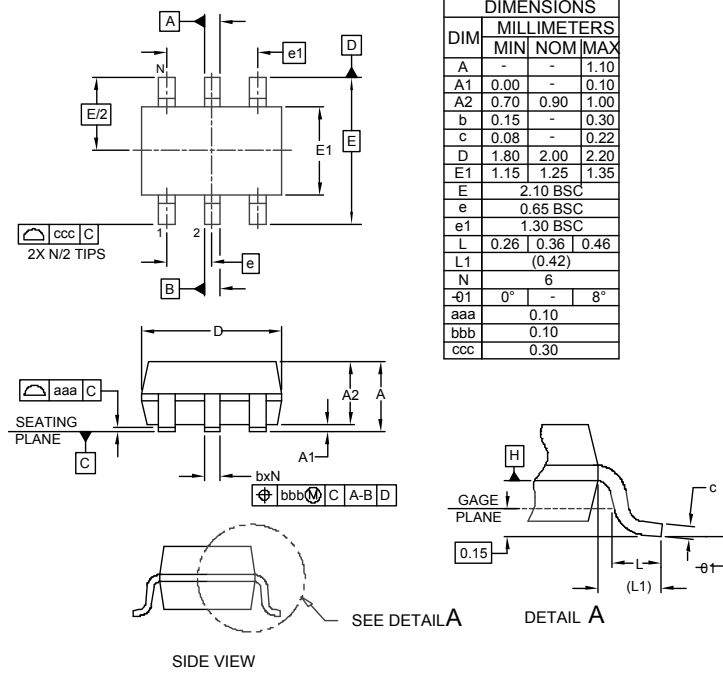

- NOTES:
1. CONTROLLING DIMENSIONS ARE IN MILLIMETERS (ANGLES IN DEGREES).
  2. DATUMS  $\boxed{-A-}$  AND  $\boxed{-B-}$  TO BE DETERMINED AT DATUM PLANE  $\boxed{-H-}$
  3. DIMENSIONS "E1" AND "D" DO NOT INCLUDE MOLD FLASH, PROTRUSIONS OR GATE BURRS.

# Land Pattern - SC70 6L

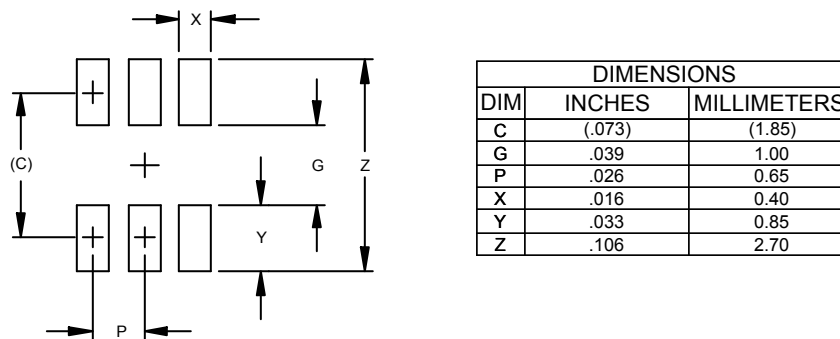

- NOTES:
1. CONTROLLING DIMENSIONS ARE IN MILLIMETERS (ANGLES IN DEGREES).
  2. THIS LAND PATTERN IS FOR REFERENCE PURPOSES ONLY. CONSULT YOUR MANUFACTURING GROUP TO ENSURE YOUR COMPANY'S MANUFACTURING GUIDELINES ARE MET.

## Marking Code

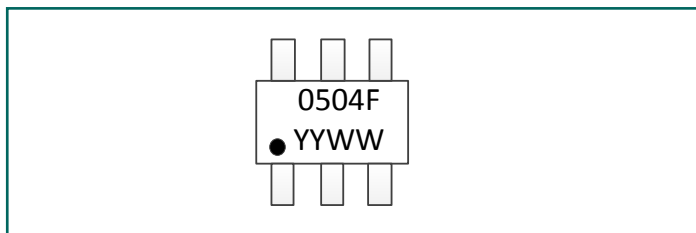

## Tape and Reel Specification

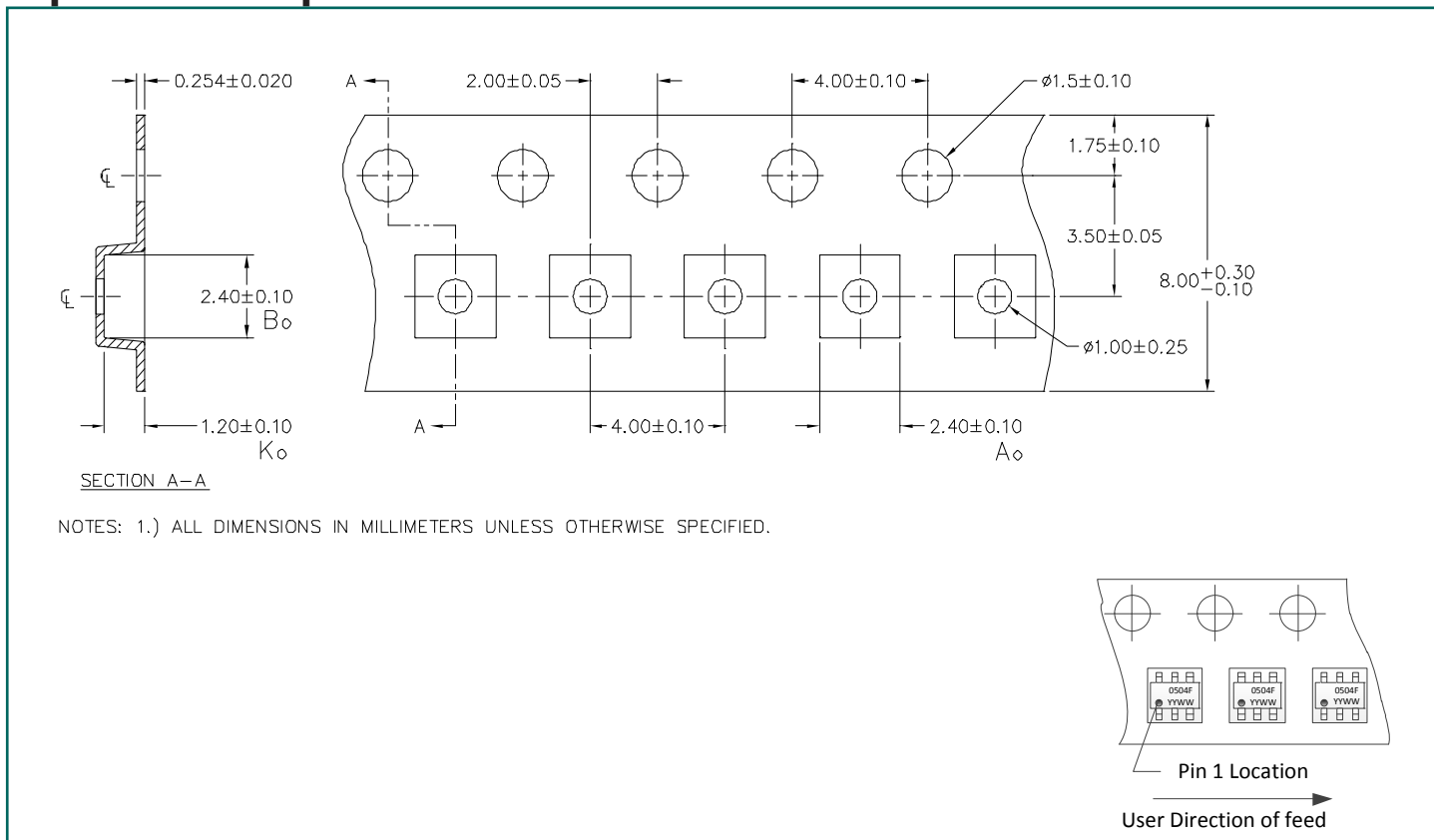

## Ordering Information

| Part Number     | Qty per Reel | Reel Size |
|-----------------|--------------|-----------|
| RClamp0504FBTCT | 3,000        | 7"        |



---

#### IMPORTANT NOTICE

Information relating to this product and the application or design described herein is believed to be reliable, however such information is provided as a guide only and Semtech assumes no liability for any errors in this document, or for the application or design described herein. Semtech reserves the right to make changes to the product or this document at any time without notice. Buyers should obtain the latest relevant information before placing orders and should verify that such information is current and complete. Semtech warrants performance of its products to the specifications applicable at the time of sale, and all sales are made in accordance with Semtech's standard terms and conditions of sale.

SEMTECH PRODUCTS ARE NOT DESIGNED, INTENDED, AUTHORIZED OR WARRANTED TO BE SUITABLE FOR USE IN LIFE-SUPPORT APPLICATIONS, DEVICES OR SYSTEMS, OR IN NUCLEAR APPLICATIONS IN WHICH THE FAILURE COULD BE REASONABLY EXPECTED TO RESULT IN PERSONAL INJURY, LOSS OF LIFE OR SEVERE PROPERTY OR ENVIRONMENTAL DAMAGE. INCLUSION OF SEMTECH PRODUCTS IN SUCH APPLICATIONS IS UNDERSTOOD TO BE UNDERTAKEN SOLELY AT THE CUSTOMER'S OWN RISK. Should a customer purchase or use Semtech products for any such unauthorized application, the customer shall indemnify and hold Semtech and its officers, employees, subsidiaries, affiliates, and distributors harmless against all claims, costs damages and attorney fees which could arise.

The Semtech name and logo are registered trademarks of the Semtech Corporation. All other trademarks and trade names mentioned may be marks and names of Semtech or their respective companies. Semtech reserves the right to make changes to, or discontinue any products described in this document without further notice. Semtech makes no warranty, representation or guarantee, express or implied, regarding the suitability of its products for any particular purpose. All rights reserved.

© Semtech 2015

---

#### Contact Information

Semtech Corporation  
200 Flynn Road, Camarillo, CA 93012  
Phone: (805) 498-2111, Fax: (805) 498-3804  
[www.semtech.com](http://www.semtech.com)