



22MM PLASTIC ROUND COMPLETE UNIT
COMBINATION: INDICATOR LIGHT WITH SMOOTH
LENSE ILLUMINATED WITH INTEGRATED LED 24V
AC/DC SCREW TERMINAL WITH HOLDER RED

Actuator / signaling device:

Design of the operating mechanism		indicator light
Color / of the activation element		Red
Material / of the activation element		plastic
Shape / of the activation element		Smooth lens
Number of switching positions		0
Product component / front ring		No
Product function / EMERGENCY STOP function		No

Contact block / lampholder

Design of the electrical connection		screw-type terminals
Number of switching elements		0
Number of NC contacts / for auxiliary contacts		0
Number of NO contacts / for auxiliary contacts		0
Number of change-over switches / for auxiliary contacts		0
Product function / positive opening		No
Number of lampholders		1
Execution of the mounting		integrated LED
Product component / fluorescent materials		Yes
Product extension / optional / fluorescent materials		Yes

Accessories:**Product component / holder for 3 switching elements**

No

General technical details:**Type of voltage / of the supply voltage / of the fluorescent material**

- of the fluorescent material / at 60 Hz / for AC / rated value
- of the fluorescent material / at 50 Hz / for AC / rated value
- of the fluorescent material / for DC / rated value

V

AC/DC

24

V

24

V

24

Type of voltage / of the operating voltage

AC/DC

Operating voltage / rated value

- minimum
- maximum

V

19

V

30

Resistance against shock

- for devices without incandescent lamp / according to IEC 60068-2-27

<= 50g

Resistance against vibration / according to IEC 60068-2-6

20 ... 200 Hz: 5g

Item designation

- according to DIN EN 61346-2
- according to DIN 40719 extendable after IEC 204-2 / according to IEC 750

P

H

Tightening torque / of the screws in the bracket / maximum

N·m

1

Ambient temperature

- during operating
- during storage

°C

-25 ... +70

°C

-40 ... +80

Protection class IP

IP66

climatic class / during the operating phase / according to EN 60721

3K6

Type of mounting

front mounting

Shape / of the installation hole

round

Installation width

mm

28

Mounting diameter

mm

22

Mounting height

mm











11

Mounting depth

mm

49

Certificates/approvals:

General Product Approval				Declaration of Conformity	Test Certificates
 CCC	 CSA	 GOST	 UL	 EG-Konf.	Special Test Certificate
Shipping Approval					
 ABS	 BUREAU VERITAS	 DNV	 LRS	 PRS	 RINA
other					
Confirmation	other	Environmental Confirmations			
Further information:					
Information- and Downloadcenter (Catalogs, Brochures,...) http://www.siemens.com/industrial-controls/catalogs					
Industry Mall (Online ordering system) http://www.siemens.com/industrial-controls/mall					
Cax online generator: http://www.siemens.com/cax					
Service&Support (Manuals, Certificates, Characteristics, FAQs,...) http://support.automation.siemens.com/WW/view/en/3SB3244-6AA20/all					
Image database (product images, 2D dimension drawings, 3D models, device circuit diagrams, ...) http://www.automation.siemens.com/bilddb/cax_en.aspx?mlfb=3SB3244-6AA20					

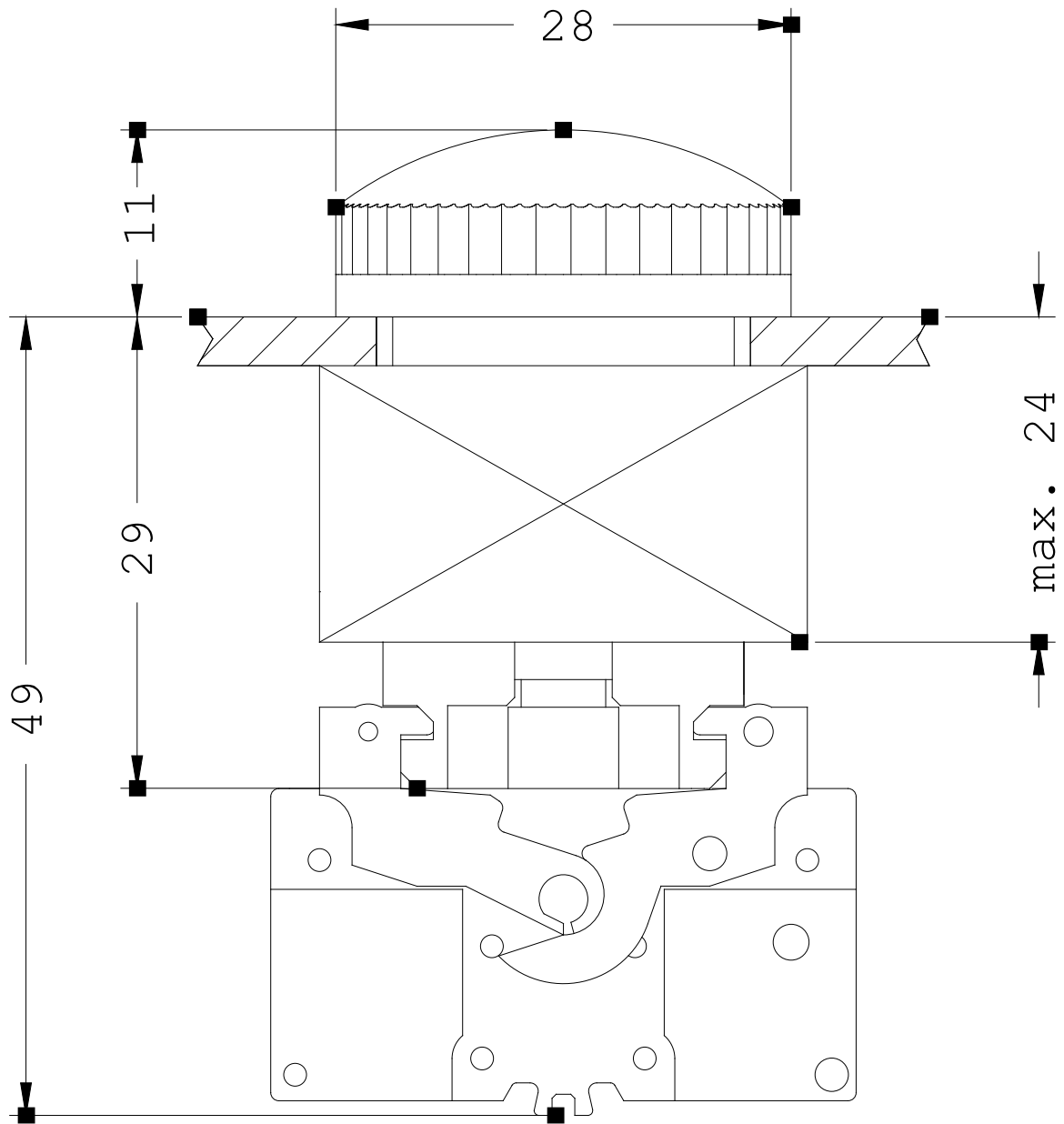

last change:

Jul 17, 2012