

DATA SHEET

# SKY67003-396LF: 2.0-3.0 GHz High Linearity, Active Bias Low-Noise Amplifier

## Applications

- CDMA, WCDMA, TD-SCDMA, WiMAX, LTE cellular infrastructure
- Ultra low-noise systems
- Balanced, single-ended low-noise amplifier designs

## Features

- Extended operating temperature range: -40 °C to +100 °C
- Low Noise Figure: 0.89 dB @ 2.6 GHz
- Excellent IIP3 performance: +21.5 dBm @ 2.6 GHz
- Gain: 17.5 dB @ 2.6 GHz
- Adjustable supply current
- Integrated enable circuitry
- Temperature and process-stable active bias
- Miniature DFN (8-pin, 2 x 2 mm) package (MSL1 @ 260 °C per JEDEC J-STD-020)



Skyworks Green™ products are compliant with all applicable legislation and are halogen-free. For additional information, refer to *Skyworks Definition of Green™*, document number SQ04-0074.

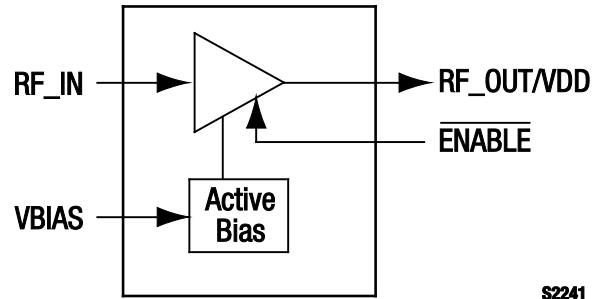

Figure 1. SKY67003-396LF Block Diagram

## Description

The SKY67003-396LF is GaAs, pHEMT Low-Noise Amplifier (LNA) with an active bias and high linearity performance. The advanced GaAs pHEMT enhancement mode process provides good return loss, low noise, and high linearity performance.

The internal active bias circuitry provides stable performance over temperature and process variation. The device offers the ability to externally adjust supply current and gain. Supply voltage is applied to the RFOUT/VDD pin through an RF choke inductor. Pin 3 (VBIAS) should be connected to RFOUT/VDD through an external resistor to control the supply current. The RFIN and RFOUT/VDD pins should be DC blocked to ensure proper operation.

The SKY67003-396LF operates in the frequency range of 2.2 to 3.0 GHz. For lower frequency operation, the pin-compatible SKY67002-396LF or SKY67001-396LF should be used.

The LNA is manufactured in a compact, 2 x 2 mm, 8-pin Dual Flat No-Lead (DFN) package. A functional block diagram is shown in Figure 1. The pin configuration and package are shown in Figure 2. Signal pin assignments and functional pin descriptions are provided in Table 1.

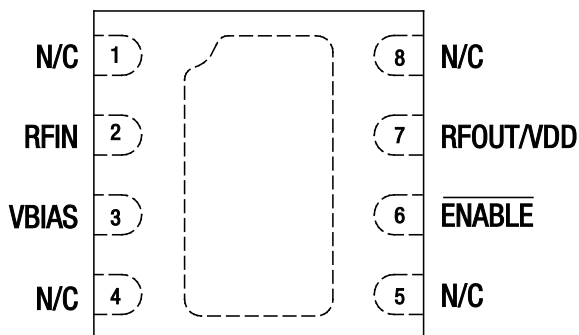

S2240

Figure 2. SKY67003-396LF Pinout – 8-Pin DFN (Top View)

**Table 1. SKY67003-396LF Signal Descriptions**

Pin #	Name	Description	Pin #	Name	Description
1	N/C	No connection. May be connected to ground with no change in performance.	5	N/C	No connection. May be connected to ground with no change in performance.
2	RFIN	RF input. DC blocking capacitor required.	6	ENABLE	Enable pin. Active “low” (0 V) = amplifier on state.
3	VBIAS	Bias for 1 <sup>st</sup> stage amplifier. External resistor sets current consumption.	7	RFOUT/VDD	RF output. Apply VDD through RF choke inductor. DC blocking capacitor required.
4	N/C	No connection. May be connected to ground with no change in performance.	8	N/C	No connection. May be connected to ground with no change in performance.

**Table 2. SKY67003-396LF Absolute Maximum Ratings**

Parameter	Symbol	Minimum	Typical	Maximum	Units
Supply voltage	V <sub>DD</sub>			5.5	V
RF input power	P <sub>IN</sub>			+20	dBm
Channel temperature	T <sub>CH</sub>			+150	°C
Thermal resistance (@ 5 V bias)	Θ <sub>JC</sub>		62.2		°C/W
Storage temperature	T <sub>STG</sub>	-65	+25	+150	°C
Operating temperature	T <sub>A</sub>	-55	+25	+100	°C

**Notes:** Exposure to maximum rating conditions for extended periods may reduce device reliability. There is no damage to device with only one parameter set at the limit and all other parameters set at or below their nominal value. Exceeding any of the limits listed here may result in permanent damage to the device.

**CAUTION:** Although this device is designed to be as robust as possible, Electrostatic Discharge (ESD) can damage this device. This device must be protected at all times from ESD. Static charges may easily produce potentials of several kilovolts on the human body or equipment, which can discharge without detection. Industry-standard ESD precautions should be used at all times. The SKY67003-396LF ESD threshold level is 500 VDC using Human Body Model (HBM) testing (Class 1B), 30 VDC using Man-Machine (MM) model testing (Class A), and 1000 VDC using Charged Device Model (CDM) testing (Class IV).

**Electrical and Mechanical Specifications**

The absolute maximum ratings of the SKY67003-396LF are provided in Table 2. Electrical specifications are provided in Table 3.

Typical performance characteristics of the SKY67003-396LF are illustrated in Figures 3 through 28.

Table 4 provides noise source pull information versus frequency.

**Table 3. SKY67003-396LF Electrical Specifications (Note 1)****(V<sub>DD</sub> = 5 V, I<sub>DD</sub> = 100 mA, T<sub>A</sub> = +25 °C, P<sub>IN</sub> = -20 dBm, Characteristic Impedance [Z<sub>0</sub>] = 50 Ω, Unless Otherwise Noted)**

Parameter	Symbol	Test Condition	Min	Typical	Max	Units
<b>RF Specifications</b>						
Noise Figure (Note 2)	NF	@ 2.6 GHz		0.88	1.10	dB
Small signal gain	IS21I	@ 2.6 GHz	16.5	17.5	18.5	dB
Input return loss	IS11I	@ 2.6 GHz	12.5	14.5		dB
Output return loss	IS22I	@ 2.6 GHz	14	17		dB
Reverse isolation	IS12I	@ 2.6 GHz	27	30		dB
3 <sup>rd</sup> Order Input Intercept Point	IIP3	@ 2.6 GHz, Δf = 1 MHz, P <sub>IN</sub> = -20 dBm/tone	+20.0	+21.5		dBm
3 <sup>rd</sup> Order Output Intercept Point	OIP3	@ 2.6 GHz, Δf = 1 MHz, P <sub>IN</sub> = -20 dBm/tone	+37.5	+39.0		dBm
1 dB Input Compression Point	IP1dB	@ 2.6 GHz	+2.2	+3.2		dBm
1 dB Output Compression Point	OP1dB	@ 2.6 GHz	+18.7	+19.7		dBm
Stability (Note 3)	μ, μ1	Up to 18 GHz, -40 °C to +85 °C		> 1		-
<b>DC Specifications</b>						
Supply voltage	V <sub>DD</sub>		3.3	5.0		V
Quiescent supply current	I <sub>DD</sub>	Set with external resistor	30	100		mA
Amplifier enable off current (logic "high")	I <sub>EN</sub>			700	1000	μA
Enable rise time	T <sub>R</sub>	@ 2.6 GHz			100	μs
Enable fall time	T <sub>F</sub>	@ 2.6 GHz			100	μs

**Note 1:** Performance is guaranteed only under the conditions listed in this Table.**Note 2:** Loss from the input SMA connector and Evaluation Board up to component M1 has been de-embedded from the NF measurement (0.06 dB).**Note 3:** Applies to typical application circuit and components shown in Figure 28.

### Typical Performance Characteristics

( $V_{DD} = 5\text{ V}$ ,  $I_{DD} = 100\text{ mA}$ ,  $T_A = +25\text{ }^\circ\text{C}$ ,  $P_{IN} = -20\text{ dBm}$ , Characteristic Impedance [ $Z_0$ ] =  $50\ \Omega$ , Unless Otherwise Noted)

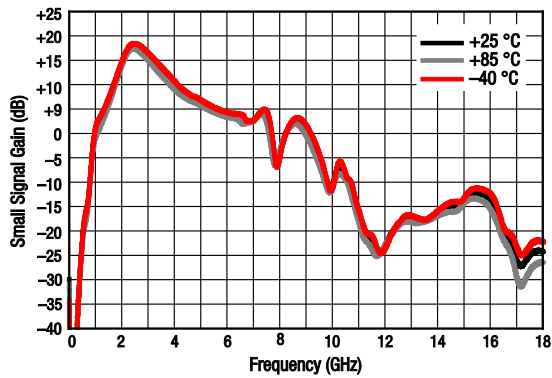

**Figure 3. Broadband Gain Response vs Frequency Over Temperature**

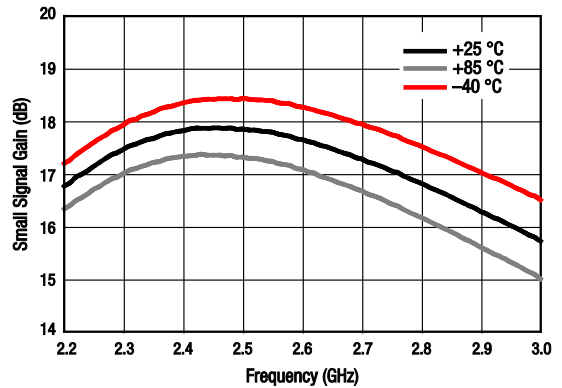

**Figure 4. Narrowband Gain Response vs Frequency Over Temperature**

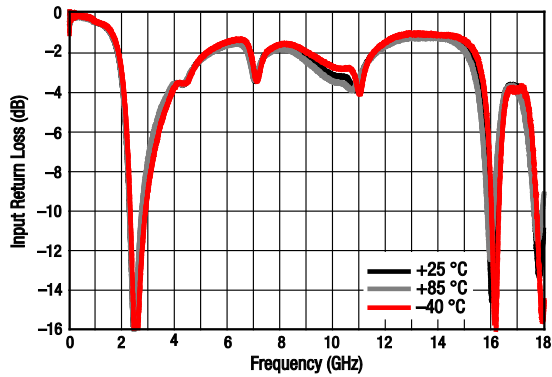

**Figure 5. Broadband Input Return Loss vs Frequency Over Temperature**

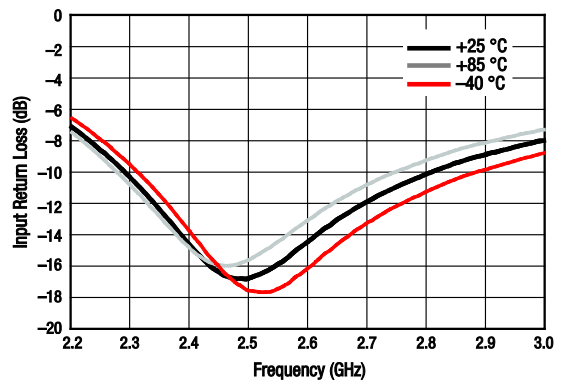

**Figure 6. Narrowband Input Return Loss vs Frequency Over Temperature**

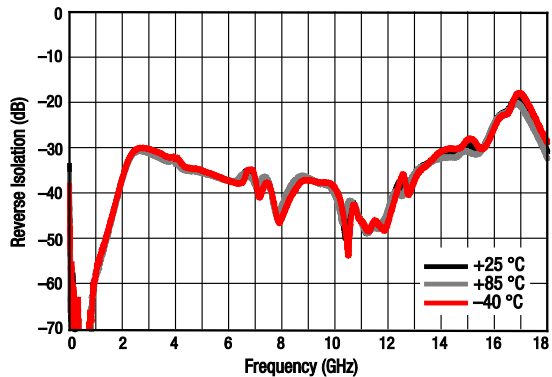

**Figure 7. Broadband Reverse Isolation vs Frequency Over Temperature**

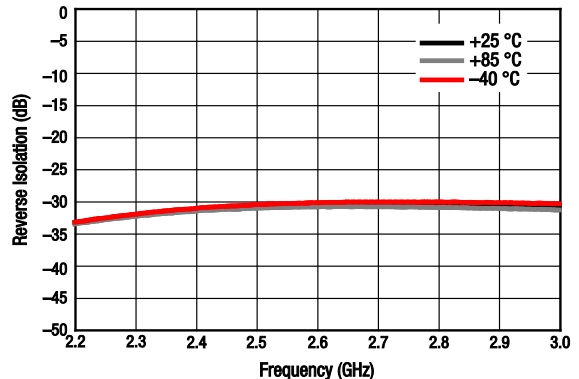

**Figure 8. Narrowband Reverse Isolation vs Frequency Over Temperature**

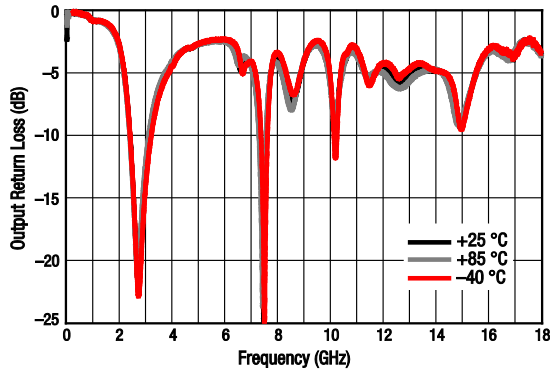

Figure 9. Broadband Output Return Loss vs Frequency Over Temperature

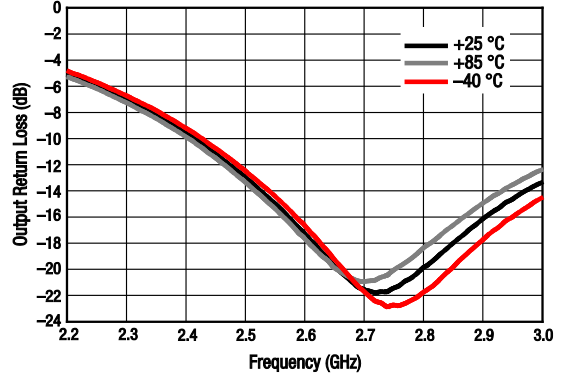

Figure 10. Narrowband Output Return Loss vs Frequency Over Temperature

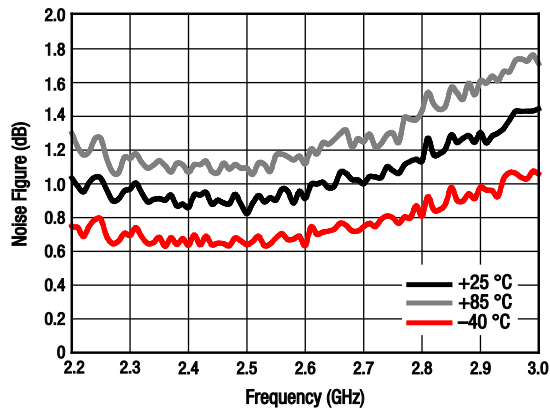

Figure 11. Noise Figure vs Frequency Over Temperature

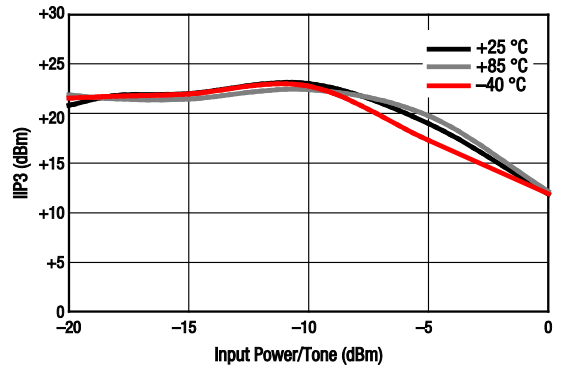

Figure 12. IIP3 vs Input Power Over Temperature @ 2200 MHz ( $P_{IN} = -20$  dBm, Tone Spacing = 1 MHz)

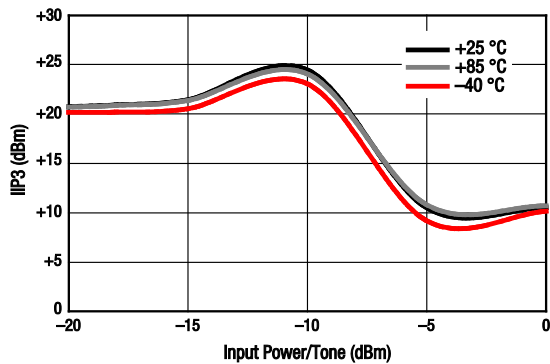

Figure 13. IIP3 vs Input Power Over Temperature @ 2500 MHz ( $P_{IN} = -20$  dBm, Tone Spacing = 1 MHz)

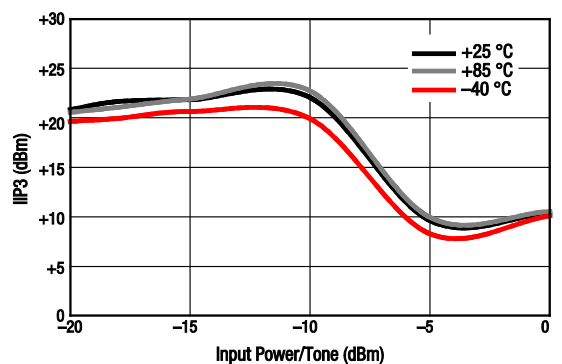
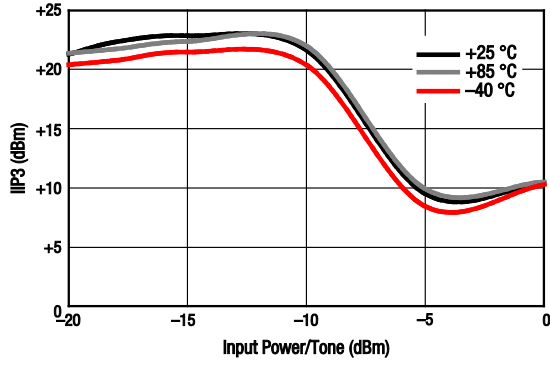
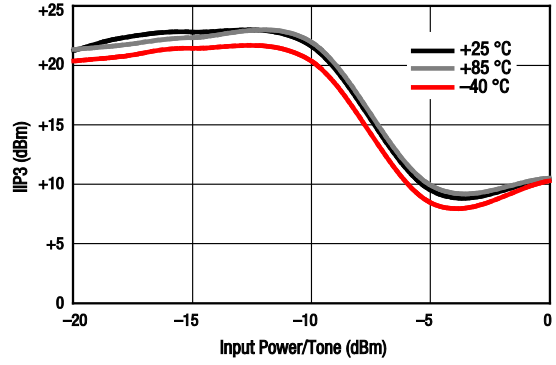

Figure 14. IIP3 vs Input Power Over Temperature @ 2600 MHz ( $P_{IN} = -20$  dBm, Tone Spacing = 1 MHz)



**Figure 15. IIP3 vs Input Power Over Temperature @ 2700 MHz ( $P_{IN} = -20$  dBm, Tone Spacing = 1 MHz)**



**Figure 16. IIP3 vs Input Power Over Temperature @ 3000 MHz ( $P_{IN} = -20$  dBm, Tone Spacing = 1 MHz)**

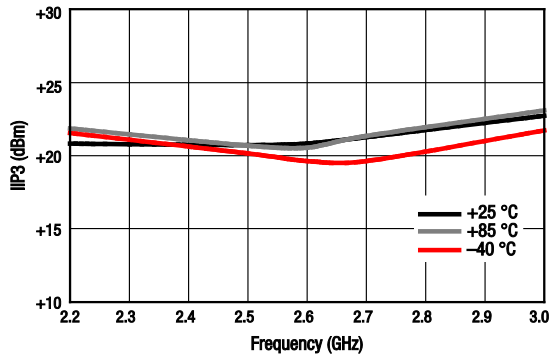

**Figure 17. IIP3 vs Frequency Over Temperature ( $P_{IN} = -20$  dBm, Tone Spacing = 1 MHz)**

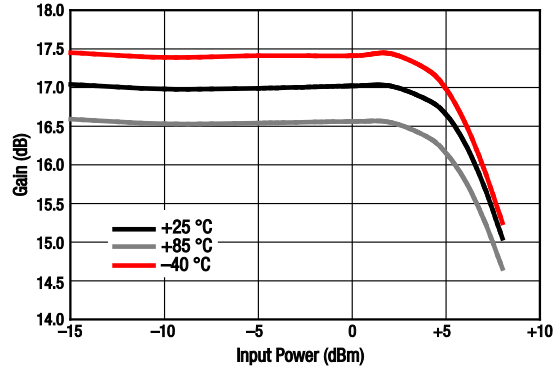

**Figure 18. Gain vs Input Power Over Temperature @ 2200 MHz**

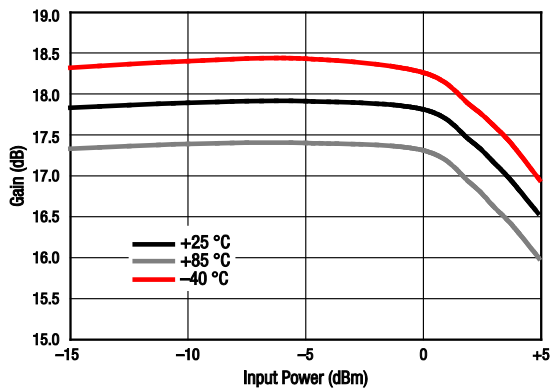

**Figure 19. Gain vs Input Power Over Temperature @ 2500 MHz**

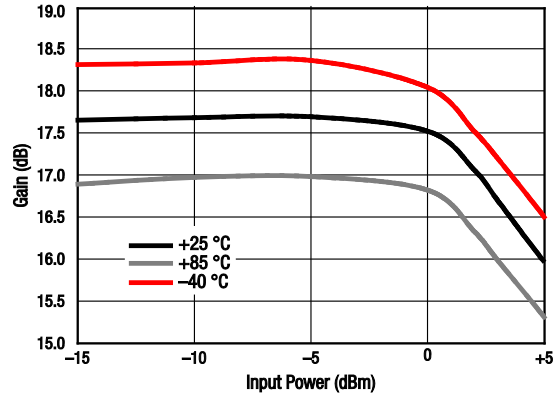

**Figure 20. Gain vs Input Power Over Temperature @ 2600 MHz**

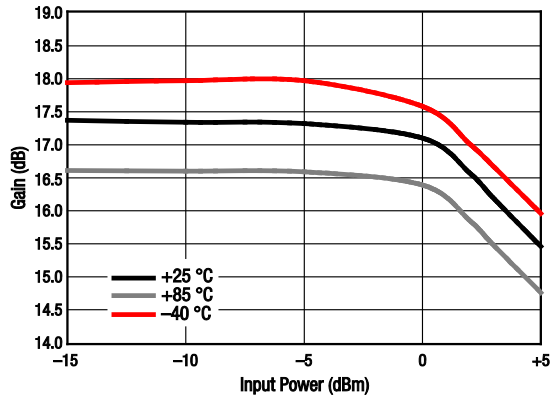

Figure 21. Gain vs Input Power Over Temperature @ 2700 MHz

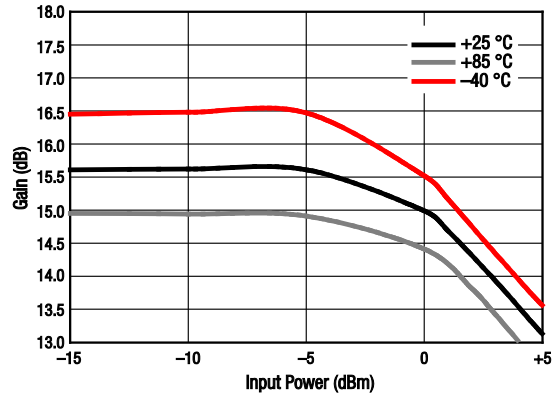

Figure 22. Gain vs Input Power Over Temperature @ 3000 MHz

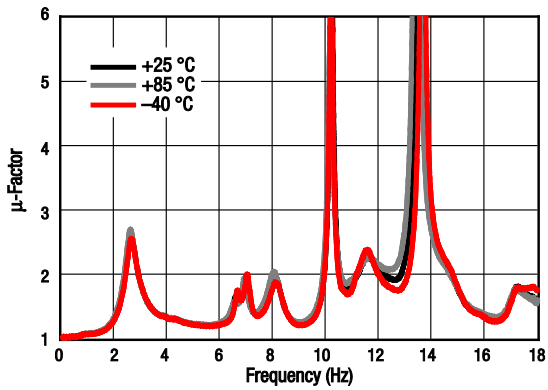

Figure 23. Stability Factor ( $\mu$ ) vs Frequency Over Temperature

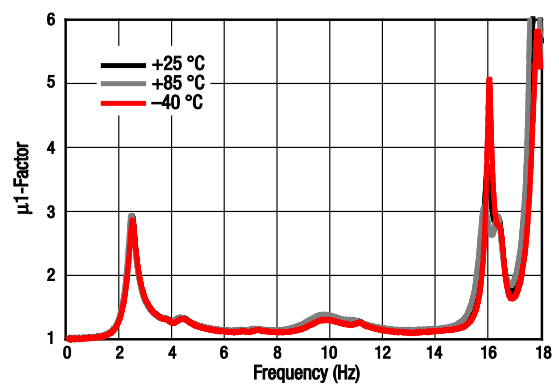

Figure 24. Stability Factor ( $\mu_1$ ) vs Frequency Over Temperature

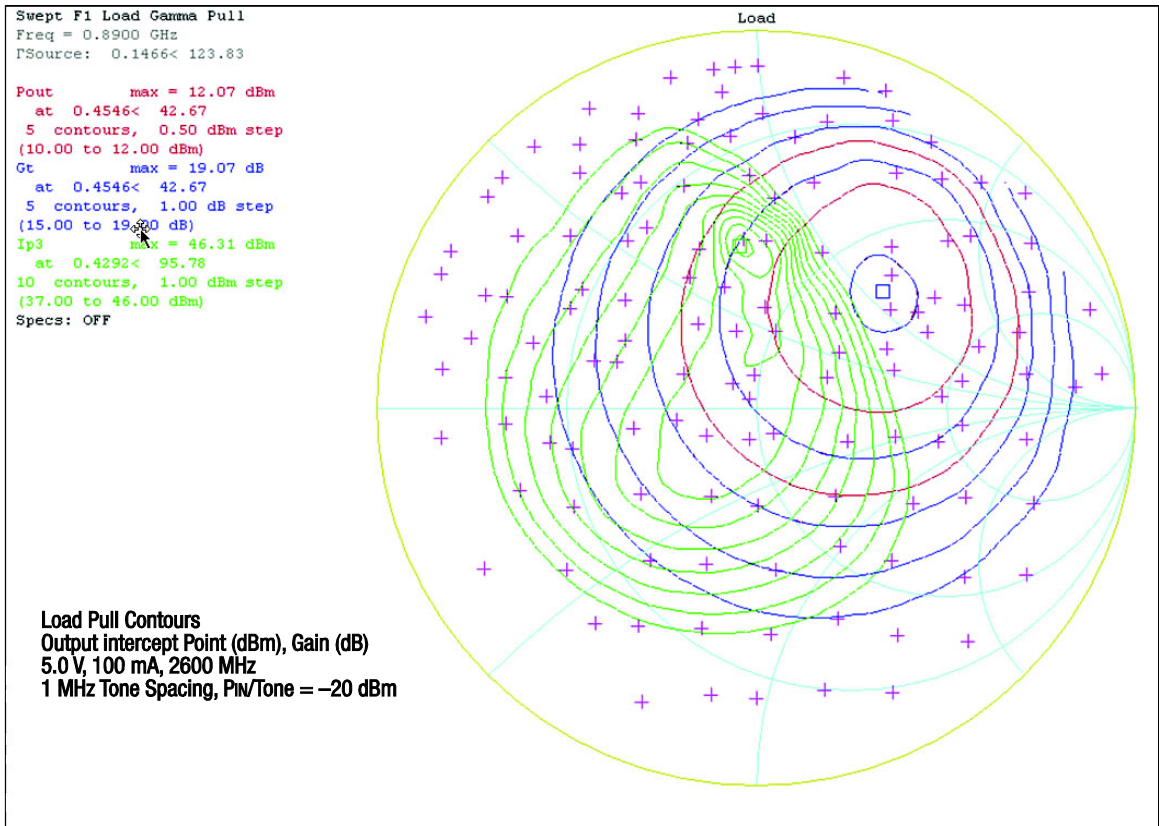

Figure 25. Load Pull, @ 5 V, 2600 MHz, 100 mA

**Table 4. Noise Parameters vs Frequency @ 25 °C**

Frequency (GHz)	Minimum Noise Figure (F <sub>MIN</sub> ) (dB)	Noise Resistance (R <sub>N</sub> ) (Ω)	Γ <sub>opt</sub>		Associated Gain (dB)	Maximum Gain (G <sub>MAX</sub> ) (dB)
			Magnitude	Phase		
1.76	0.7057	0.0355	0.3691	173.36	21.3071	21.5307
1.84	0.7128	0.0303	0.4325	174.95	21.0975	21.2198
1.92	0.7626	0.0349	0.4147	176.31	20.7651	20.9243
1.98	0.8210	0.0354	0.4253	178.77	20.5410	20.6963
2.00	0.8234	0.0315	0.4502	-177.74	20.4740	20.6304
2.10	0.8206	0.0289	0.4521	173.00	20.1849	20.2753
2.20	0.8027	0.0284	0.4939	173.30	19.9093	19.9513
2.30	0.8060	0.0257	0.5071	-179.90	19.5752	19.6218
2.38	0.9463	0.0361	0.4754	-177.32	19.2899	19.3900
2.48	0.9779	0.0396	0.4942	-170.31	18.9365	19.0858
2.70	0.9958	0.0334	0.5058	-171.79	18.4394	18.5432
3.00	1.2098	0.0486	0.5254	-163.18	17.5977	17.7746

## Evaluation Board Description

The SKY67003-396LF Evaluation Board is used to test the performance of the SKY67003-396LF LNA. An assembly drawing for the Evaluation Board is shown in Figure 26. The layer detail is provided in Figure 27. An Evaluation Board schematic diagram is provided in Figure 28. Table 5 provides the Bill of Materials (BOM) list for Evaluation Board components.

## Package Dimensions

The PCB layout footprint for the SKY67003-396LF is provided in Figure 29. Typical case markings are shown in Figure 30. Package dimensions for the 8-pin DFN are shown in Figure 31, and tape and reel dimensions are provided in Figure 32.

## Package and Handling Information

Instructions on the shipping container label regarding exposure to moisture after the container seal is broken must be followed. Otherwise, problems related to moisture absorption may occur when the part is subjected to high temperature during solder assembly.

THE SKY67003-396LF is rated to Moisture Sensitivity Level 1 (MSL1) at 260 °C. It can be used for lead or lead-free soldering. For additional information, refer to the Skyworks Application Note, *Solder Reflow Information*, document number 200164.

Care must be taken when attaching this product, whether it is done manually or in a production solder reflow environment. Production quantities of this product are shipped in a standard tape and reel format.

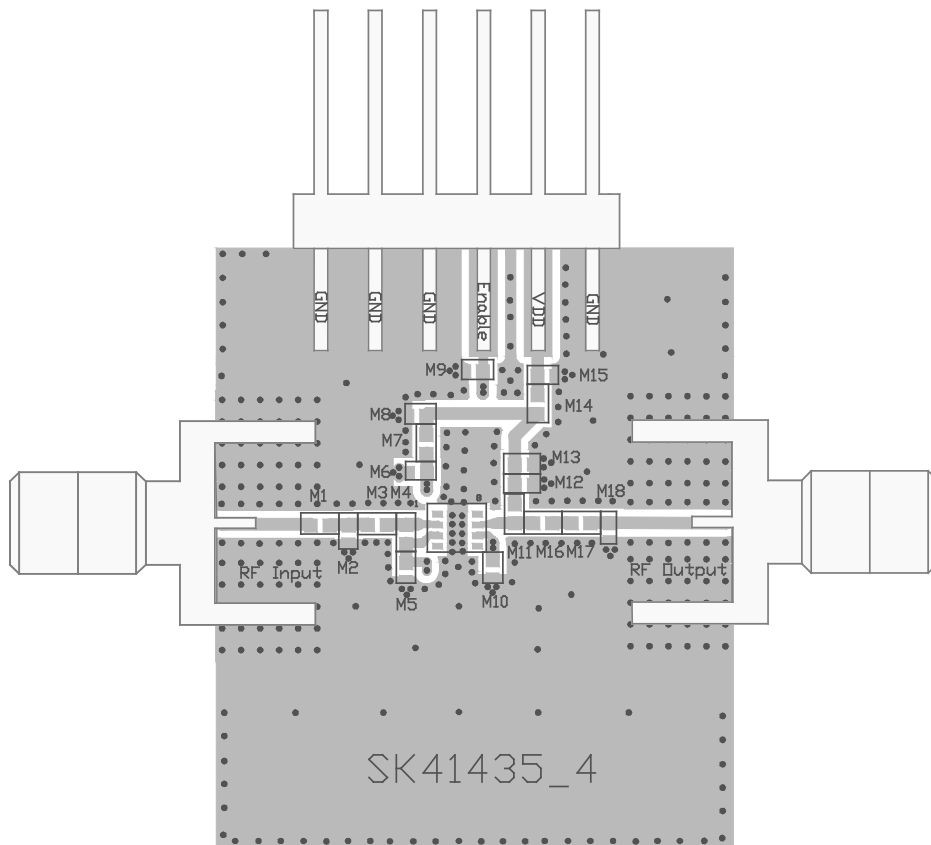

S2528

Figure 26. SKY67003-396LF Evaluation Board Assembly Diagram

Cross Section	Name	Thickness (mm)	Material
	MSK-NS		
	TRA-NS	0.3556	Cu foil
	Laminate	0.254 ± 0.152	Rogers 4350B
	TRA-2	0.0178	Cu foil
	Laminate	0.889 nom.	FR4 Prepreg (Note 1)
	TRA-3	0.0178	Cu foil
	Laminate	0.254 ± 0.152	FR4 Core
	TRA-FS	0.0178	Cu foil
	MSK-PS		

Note 1: Adjust this thickness to meet total thickness goal.

General Notes:

Material: Rogers R04350,  $\epsilon_r = 3.66$   
 Layer 1 thickness: 0.254 mm  
 Overall board thickness: 1.575 mm  
 50  $\Omega$  transmission line width: 0.522 mm  
 Coplanar ground spacing: 0.394 mm  
 Via diameter: 0.254 mm

S2630

Figure 27. Layer Detail Physical Characteristics

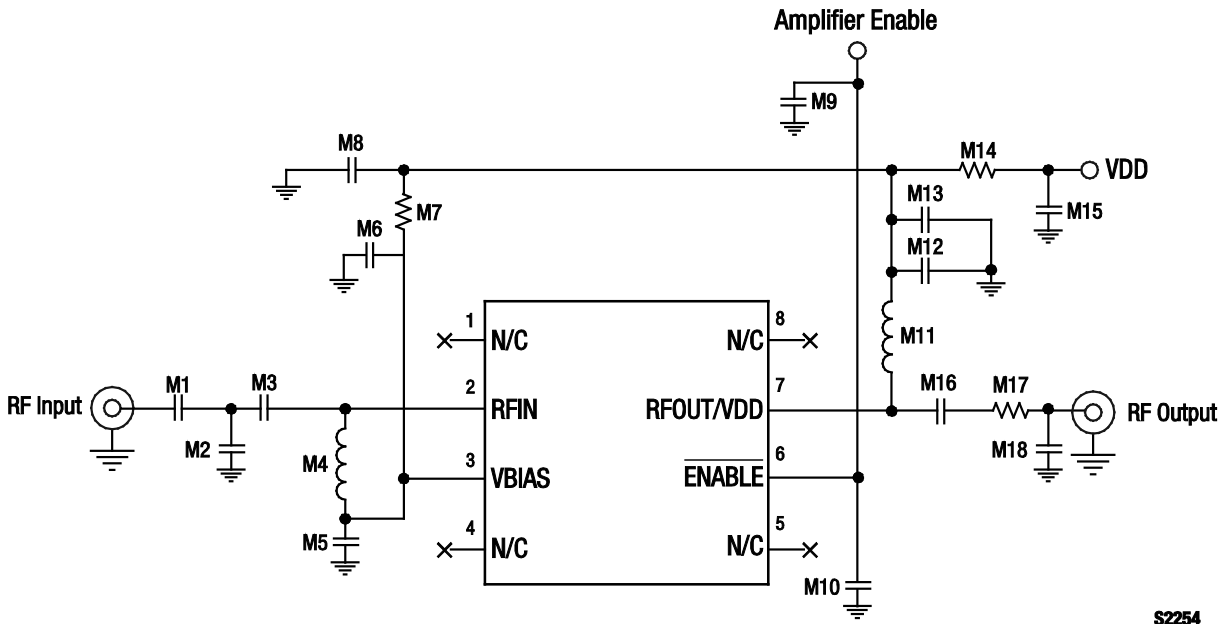
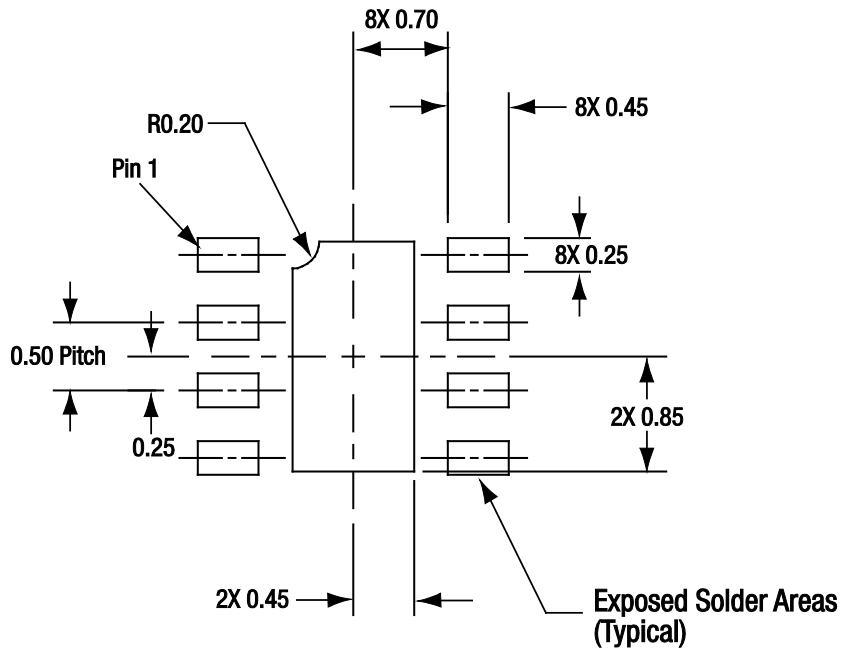

Figure 28. SKY67003-396LF Evaluation Board Schematic

Table 5. SKY67003-396LF Evaluation Board Bill of Materials

Component	Type	Value	Size	Manufacturer
M1	Resistor	0 $\Omega$	0402	Panasonic
M2	Inductor	2 nH	0402	Coilcraft HP
M3	Capacitor	1.6 pF	0402	Murata GJM
M4	Inductor	15 nH	0402	Coilcraft HP
M5	Capacitor	6 pF	0402	Murata GJM
M6	DNI			
M7	Resistor	5.6 k $\Omega$	0402	Panasonic
M8	Capacitor	1000 pF	0402	Murata GRM
M9	DNI			
M10	Resistor	0 $\Omega$	0402	Panasonic
M11	Inductor	39 nH	0402	TDK MLG
M12	Capacitor	10 pF	0402	Murata GRM
M13	Capacitor	1000 pF	0402	Murata GRM
M14	Resistor	0 $\Omega$	0402	Panasonic
M15	Capacitor	0.1 $\mu$ F	0402	Murata GRM
M16	Capacitor	2.2 pF	0402	Murata GRM
M17	Resistor	0 $\Omega$	0402	Panasonic
M18	Inductor	1.8 nH	0402	TDK MLG



All dimensions are in millimeters

S1413

**Figure 29. SKY67003-396LF PCB Layout Footprint (Top View)**

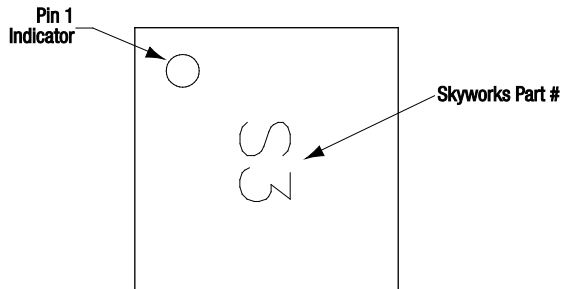

**Figure 30. Typical Case Markings (Top View)**

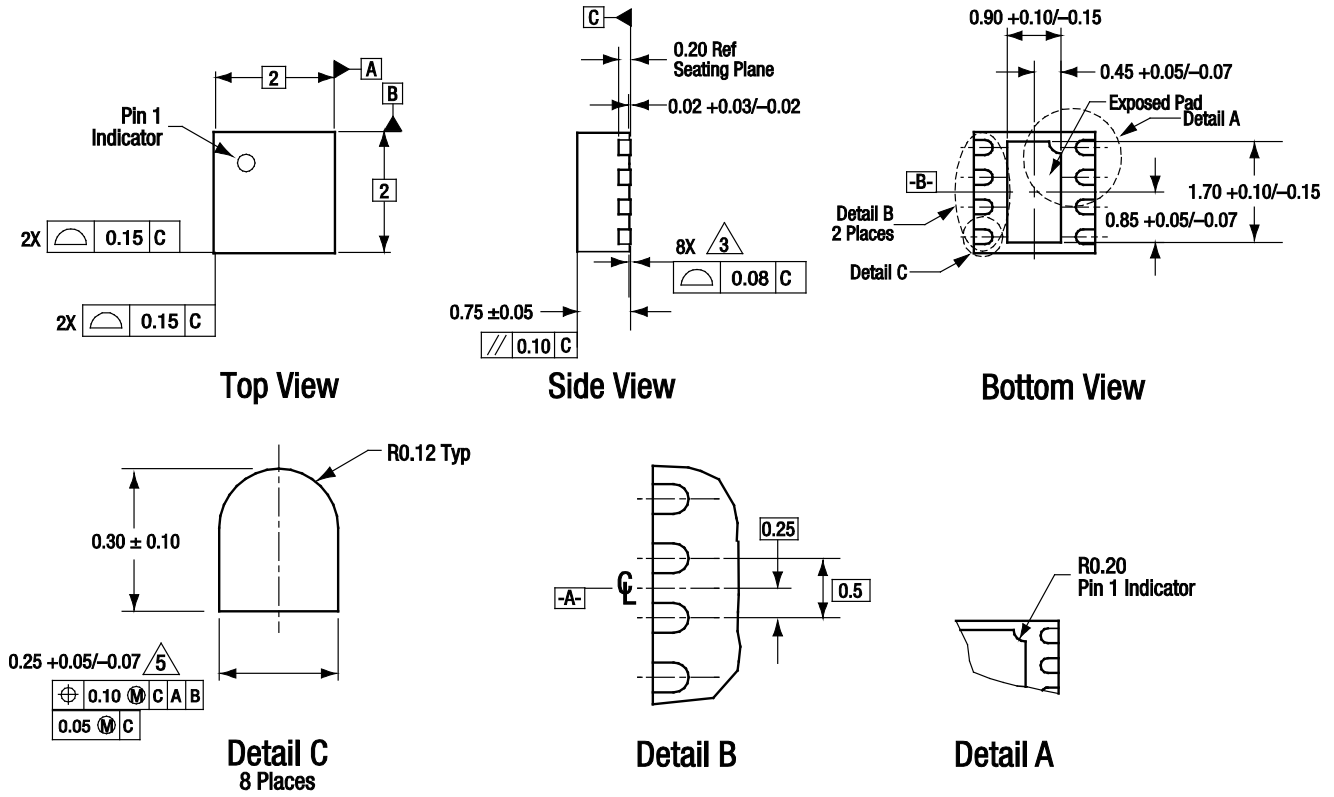

All measurements are in millimeters.  
 Dimensioning and tolerancing according to ASME Y14.5M-1994.  
 Coplanarity applies to the exposed heat sink slug as well as the terminals..  
 Plating requirement per source control drawing (SCD) 2504.  
 Dimension applies to metallized terminal and is measured between 0.15 mm and 0.30 mm from terminal tip.

S1945

Figure 31. SKY67003-396LF 8-Pin DFN Package Dimensions

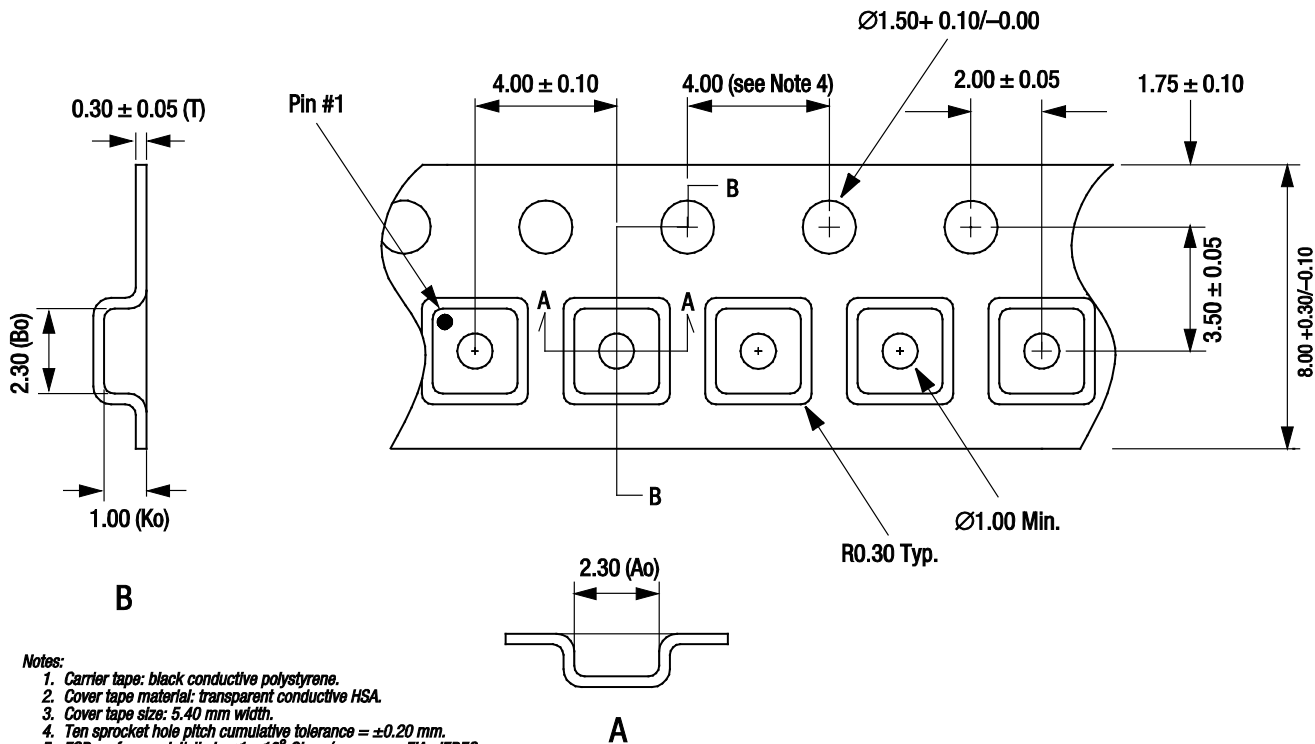

Notes:

1. Carrier tape: black conductive polystyrene.
2. Cover tape material: transparent conductive HSA.
3. Cover tape size: 5.40 mm width.
4. Ten sprocket hole pitch cumulative tolerance = ±0.20 mm.
5. ESD surface resistivity is  $\leq 1 \times 10^8$  Ohms/square per EIA, JEDEC tape and reel specification.
6. Ao and Bo measurement point to be 0.30 mm from bottom pocket.
7. All measurements are in millimeters.

S1601

Figure 32. SKY67003-396LF Tape and Reel Dimensions

## Ordering Information

Model Name	Manufacturing Part Number	Evaluation Board Part Number
SKY67003-396LF LNA	SKY67003-396LF	SKY67003-396LF-EVB

Copyright © 2011 Skyworks Solutions, Inc. All Rights Reserved.

Information in this document is provided in connection with Skyworks Solutions, Inc. ("Skyworks") products or services. These materials, including the information contained herein, are provided by Skyworks as a service to its customers and may be used for informational purposes only by the customer. Skyworks assumes no responsibility for errors or omissions in these materials or the information contained herein. Skyworks may change its documentation, products, services, specifications or product descriptions at any time, without notice. Skyworks makes no commitment to update the materials or information and shall have no responsibility whatsoever for conflicts, incompatibilities, or other difficulties arising from any future changes.

No license, whether express, implied, by estoppel or otherwise, is granted to any intellectual property rights by this document. Skyworks assumes no liability for any materials, products or information provided hereunder, including the sale, distribution, reproduction or use of Skyworks products, information or materials, except as may be provided in Skyworks Terms and Conditions of Sale.

THE MATERIALS, PRODUCTS AND INFORMATION ARE PROVIDED "AS IS" WITHOUT WARRANTY OF ANY KIND, WHETHER EXPRESS, IMPLIED, STATUTORY, OR OTHERWISE, INCLUDING FITNESS FOR A PARTICULAR PURPOSE OR USE, MERCHANTABILITY, PERFORMANCE, QUALITY OR NON-INFRINGEMENT OF ANY INTELLECTUAL PROPERTY RIGHT; ALL SUCH WARRANTIES ARE HEREBY EXPRESSLY DISCLAIMED. SKYWORKS DOES NOT WARRANT THE ACCURACY OR COMPLETENESS OF THE INFORMATION, TEXT, GRAPHICS OR OTHER ITEMS CONTAINED WITHIN THESE MATERIALS. SKYWORKS SHALL NOT BE LIABLE FOR ANY DAMAGES, INCLUDING BUT NOT LIMITED TO ANY SPECIAL, INDIRECT, INCIDENTAL, STATUTORY, OR CONSEQUENTIAL DAMAGES, INCLUDING WITHOUT LIMITATION, LOST REVENUES OR LOST PROFITS THAT MAY RESULT FROM THE USE OF THE MATERIALS OR INFORMATION, WHETHER OR NOT THE RECIPIENT OF MATERIALS HAS BEEN ADVISED OF THE POSSIBILITY OF SUCH DAMAGE.

Skyworks products are not intended for use in medical, lifesaving or life-sustaining applications, or other equipment in which the failure of the Skyworks products could lead to personal injury, death, physical or environmental damage. Skyworks customers using or selling Skyworks products for use in such applications do so at their own risk and agree to fully indemnify Skyworks for any damages resulting from such improper use or sale.

Customers are responsible for their products and applications using Skyworks products, which may deviate from published specifications as a result of design defects, errors, or operation of products outside of published parameters or design specifications. Customers should include design and operating safeguards to minimize these and other risks. Skyworks assumes no liability for applications assistance, customer product design, or damage to any equipment resulting from the use of Skyworks products outside of stated published specifications or parameters.

Skyworks, the Skyworks symbol, and "Breakthrough Simplicity" are trademarks or registered trademarks of Skyworks Solutions, Inc., in the United States and other countries. Third-party brands and names are for identification purposes only, and are the property of their respective owners. Additional information, including relevant terms and conditions, posted at [www.skyworksinc.com](http://www.skyworksinc.com), are incorporated by reference.