

High Value Multilayer Ceramic Capacitors (High dielectric type)

UMK316B7225MD-T

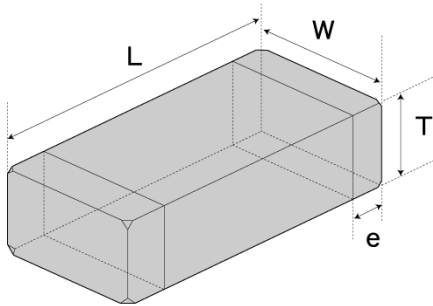

■ Features

- Item Summary
2.2 μ F \pm 20%, 50V,
X7R, 1206/3216 (EIA/JIS)
- Lifecycle Stage
Mass Production
- Standard packaging quantity (minimum)
Taping paper 4000pcs

■ Products characteristics table

Capacitance	2.2 μ F \pm 20 %
Case Size (EIA/JIS)	1206/3216
Rated Voltage	50 V
$\tan \delta$ (max)	10 %
Temperature Characteristic (EIA)	X7R
Operating Temp. Range (EIA)	-55 to +125 °C
High Temperature Loading (% Rated Voltage)	150 %
Insulation Resistance (min)	100 M Ω · μ F
RoHS2 Compliance (10 subst.)	Yes
REACH Compliance (181 subst.)	Yes
Halogen Free	Yes
Soldering	Reflow

■ External Dimensions

Dimension L	3.2 \pm 0.15 mm
Dimension W	1.6 \pm 0.15 mm
Dimension T	0.85 \pm 0.10 mm
Dimension e	0.50 +0.35/-0.25 mm

2018.03.10

The data is reference only. Electrical characteristics vary depending on environment or measurement condition.
 TAIYO YUDEN reserves the right to make change to the data at any time without notice.
 Before making final selection, please check product specification.

Multi Layer Ceramic Capacitor **TAIYO YUDEN**

-Electrical Characteristics Data-

16R2A03

RoHS compliance product

○UMK316B7225MD

50V 3216 X7R 2.2 μ F +/- 20% t=0.95mmMAX
50V 1206 X7R 2.2 μ F +/- 20% t=0.037inchMAX

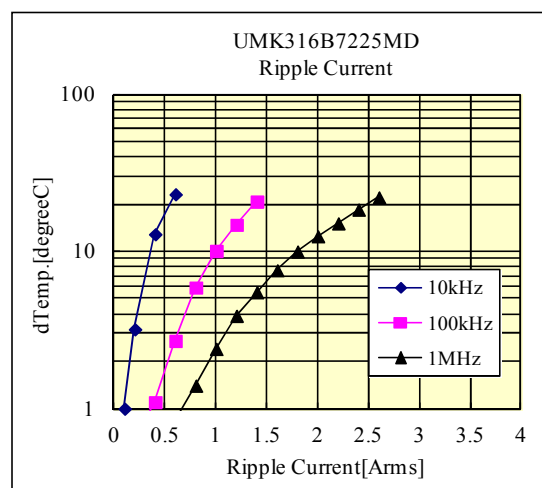
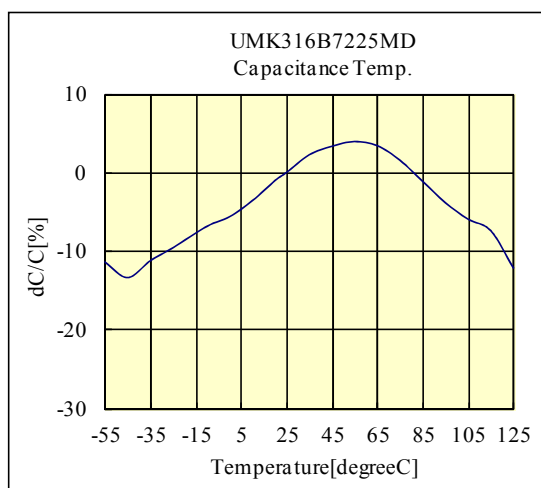
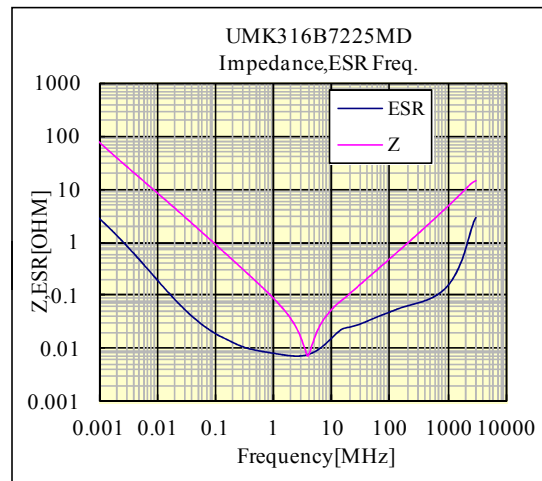
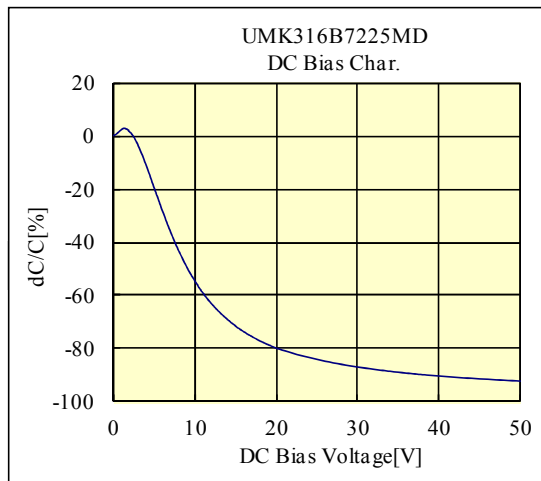
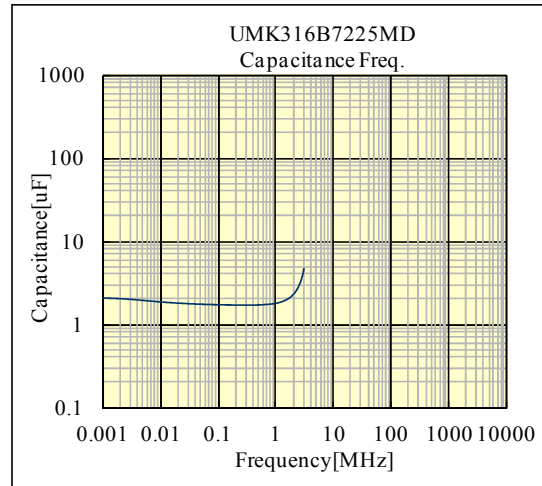
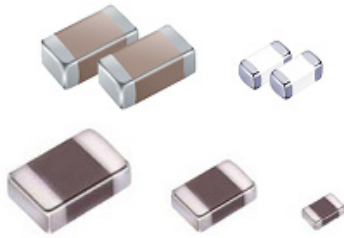

部品特性は設置環境、測定条件等により変化する場合があります。本データをご使用される際は実際の製品特性に対する参考データとしてご利用ください。また、本データは予告無く追加・削除及び変更を行う場合があります。ご注文の際は、納入仕様書のご確認をお願いします。

The data is reference only. Electrical characteristics vary depending on environment or measurement condition.

TAIYO YUDEN reserves the right to make change to the data at any time without notice.

Before making final selection, please check product specification.

Please read this notice before using the TAIYO YUDEN products.



REMINDERS

- Please conduct validation and verification of our products in actual condition of mounting and operating environment before using our products.
- The product listed in this spec sheet is intended for use in general electronic equipment (e.g., AV equipment, OA equipment, home electric appliances, office equipment, information and communication equipment including, without limitation, mobile phone, and PC) and medical equipment classified as Class I or II by IMDRF. Please be sure to contact TAIYO YUDEN for further information before using the products for any equipment which may directly cause loss of human life or bodily injury (e.g., transportation equipment including, without limitation, automotive powertrain control system, train control system, and ship control system, traffic signal equipment, disaster prevention equipment, medical equipment classified as Class III by IMDRF, highly public information network equipment including, without limitation, telephone exchange, and base station).

Please do not incorporate our products into any equipment requiring high levels of safety and/or reliability (e.g., aerospace equipment, aviation equipment*, medical equipment classified as Class IV by IMDRF, nuclear control equipment, undersea equipment, military equipment).

*Note: There is a possibility that our products can be used only for aviation equipment that does not directly affect the safe operation of aircraft (e.g., in-flight entertainment, cabin light, electric seat, cooking equipment) if such use meets requirements specified separately by TAIYO YUDEN. Please be sure to contact TAIYO YUDEN for further information before using our products for such aviation equipment.

When our products are used even for high safety and/or reliability-required devices or circuits of general electronic equipment, it is strongly recommended to perform a thorough safety evaluation prior to use of our products and to install a protection circuit as necessary.

Please note that unless you obtain prior written consent of TAIYO YUDEN, TAIYO YUDEN shall not be in any way responsible for any damages incurred by you or third parties arising from use of the product listed in this spec sheet for any equipment requiring inquiry to TAIYO YUDEN or prohibited for use by TAIYO YUDEN as described above.

- Information contained in this spec sheet is intended to convey examples of typical performances and/or applications of our products and is not intended to make any warranty with respect to the intellectual property rights or any other related rights of TAIYO YUDEN or any third parties nor grant any license under such rights.
- Please note that the scope of warranty for our products is limited to the delivered our products themselves and TAIYO YUDEN shall not be in any way responsible for any damages resulting from a fault or defect in our products. Notwithstanding the foregoing, if there is a written agreement (e.g., supply and purchase agreement, quality assurance agreement) signed by TAIYO YUDEN and your company, TAIYO YUDEN will warrant our products in accordance with such agreement.
- The contents of this spec sheet are applicable to our products which are purchased from our sales offices or authorized distributors (hereinafter “TAIYO YUDEN’s official sales channel”). Please note that the contents of this spec sheet are not applicable to our products purchased from any seller other than TAIYO YUDEN’s official sales channel.
- Caution for Export
The product listed in this spec sheet may require specific procedures for export according to “U.S. Export Administration Regulations”, “Foreign Exchange and Foreign Trade Control Law” of Japan, and other applicable regulations. Should you have any questions on this matter, please contact our sales staff.