



Inductors for High Frequency

Multilayer Ceramic

MLK series (For automobiles)

MLK1005

1005 [0402 inch]*

* Dimensions Code JIS[EIA]

REMINDERS FOR USING THESE PRODUCTS

Before using these products, be sure to request the delivery specifications.

SAFETY REMINDERS

Please pay sufficient attention to the warnings for safe designing when using these products.

REMINDERS

- The storage period is less than 12 months. Be sure to follow the storage conditions (Temperature: 5 to 40°C, Humidity: 10 to 75% RH or less).
If the storage period elapses, the soldering of the terminal electrodes may deteriorate.
- Do not use or store in locations where there are conditions such as gas corrosion (salt, acid, alkali, etc.).
- Before soldering, be sure to preheat components.
The preheating temperature should be set so that the temperature difference between the solder temperature and chip temperature does not exceed 150°C.
- Soldering corrections after mounting should be within the range of the conditions determined in the specifications.
If overheated, a short circuit, performance deterioration, or lifespan shortening may occur.
- When embedding a printed circuit board where a chip is mounted to a set, be sure that residual stress is not given to the chip due to the overall distortion of the printed circuit board and partial distortion such as at screw tightening portions.
- Self heating (temperature increase) occurs when the power is turned ON, so the tolerance should be sufficient for the set thermal design.
- Carefully lay out the coil for the circuit board design of the non-magnetic shield type.
A malfunction may occur due to magnetic interference.
- Use a wrist band to discharge static electricity in your body through the grounding wire.
- Do not expose the products to magnets or magnetic fields.
- Do not use for a purpose outside of the contents regulated in the delivery specifications.
- The products listed on this catalog are intended for use in general electronic equipment (AV equipment, telecommunications equipment, home appliances, amusement equipment, computer equipment, personal equipment, office equipment, measurement equipment, industrial robots) under a normal operation and use condition.
The products are not designed or warranted to meet the requirements of the applications listed below, whose performance and/or quality require a more stringent level of safety or reliability, or whose failure, malfunction or trouble could cause serious damage to society, person or property.
If you intend to use the products in the applications listed below or if you have special requirements exceeding the range or conditions set forth in the each catalog, please contact us.

- (1) Aerospace/Aviation equipment
- (2) Transportation equipment (electric trains, ships, etc.)
- (3) Medical equipment
- (4) Power-generation control equipment
- (5) Atomic energy-related equipment
- (6) Seabed equipment
- (7) Transportation control equipment

- (8) Public information-processing equipment
- (9) Military equipment
- (10) Electric heating apparatus, burning equipment
- (11) Disaster prevention/crime prevention equipment
- (12) Safety equipment
- (13) Other applications that are not considered general-purpose applications

When designing your equipment even for general-purpose applications, you are kindly requested to take into consideration securing protection circuit/device or providing backup circuits in your equipment.

Inductors for High Frequency Circuits

Multilayer Ceramic

Product compatible with RoHS directive
Halogen-free
Compatible with lead-free solders
AEC-Q200

Overview of the MLK Series

FEATURES

- With the adoption of a giga-spiral laminated structure, a self-resonant frequency higher than that of the MLG structure can be obtained, while the decrease of Q in the GHz band is limited.
- Monolithic structure is formed using a multilayering and sintering process with ceramic and conductive materials for high-frequency.
- There is no directivity.

APPLICATION

Automotive equipment, smart phones, tablet terminals, high frequency modules (PAs, VCOs, FEMs , etc.), Bluetooth, W-LAN, UWB, tuners and other high frequency circuits for the mobile communication industry

PART NUMBER CONSTRUCTION

MLK	1005		S	1N0		S	T		D25
Series name	LxWxH Dimensions (mm)		Characteristics	Inductance (μH)		Inductance tolerance		Packaging style	Internal code
	1005	1.0x0.5x0.5	S	1N1	1.1	S	±0.3nH	T	D25
				11N	11	J	±5%		
				R10	100				

OPERATING TEMPERATURE RANGE, PACKAGE QUANTITY, PRODUCT WEIGHT

Type	Temperature range		Package quantity	Individual weight
	Operating temperature	Storage temperature*		
	(°C)	(°C)	(pieces/reel)	(mg)
MLK1005	-55 to +125	-55 to +125	10000	1

* The Storage temperature range is for after the circuit board is mounted.

- RoHS Directive Compliant Product: See the following for more details related to RoHS Directive compliant products. <http://www.tdk.co.jp/rohs/>
- Halogen-free: Indicates that Cl content is less than 900ppm, Br content is less than 900ppm, and that the total Cl and Br content is less than 1500ppm.

• All specifications are subject to change without notice.

Overview of the MLK Series

RECOMMENDED REFLOW PROFILE

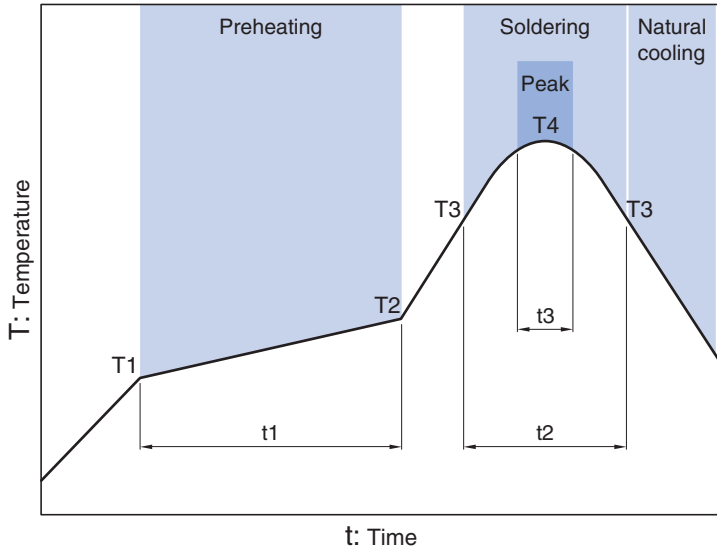

Preheating			Soldering		Peak	
Temp.		Time	Temp.	Time	Temp.	Time
T1	T2	t1	T3	t2	T4	t3
150°C	180°C	60 to 120s	230°C	30 to 60s	250 to 260°C	10s max.

• All specifications are subject to change without notice.

MLK series

MLK1005 Type



■ SHAPE & DIMENSIONS

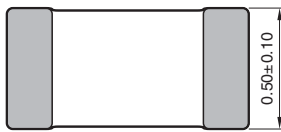
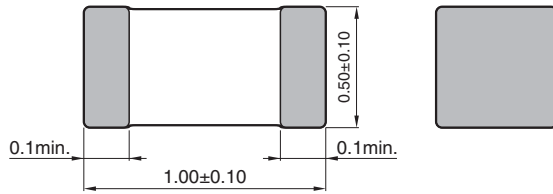

Dimensions in mm

■ RECOMMENDED LAND PATTERN

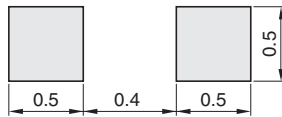

Dimensions in mm

• All specifications are subject to change without notice.

MLK series **MLK1005 Type**

■ ELECTRICAL CHARACTERISTICS

□ CHARACTERISTICS SPECIFICATION TABLE

L (nH)	Tolerance	Q min.	Q measuring frequency (MHz)	Self-resonant frequency (GHz)		DC resistance (Ω)		Rated current (mA) max.	Part No.
				min.	typ.	max.	typ.		
1.0	$\pm 0.3\text{nH}$	5	100	12.0	16.9	0.10	0.05	500	MLK1005S1N0STD25
1.1	$\pm 0.3\text{nH}$	5	100	11.5	14.8	0.12	0.05	500	MLK1005S1N1STD25
1.2	$\pm 0.3\text{nH}$	5	100	11.0	14.4	0.12	0.05	500	MLK1005S1N2STD25
1.3	$\pm 0.3\text{nH}$	5	100	10.0	12.6	0.15	0.06	500	MLK1005S1N3STD25
1.5	$\pm 0.3\text{nH}$	6	100	9.5	12.2	0.15	0.06	500	MLK1005S1N5STD25
1.6	$\pm 0.3\text{nH}$	6	100	9.0	11.9	0.17	0.06	500	MLK1005S1N6STD25
1.8	$\pm 0.3\text{nH}$	6	100	8.5	10.9	0.17	0.07	500	MLK1005S1N8STD25
2.0	$\pm 0.3\text{nH}$	6	100	8.3	10.0	0.18	0.08	500	MLK1005S2N0STD25
2.2	$\pm 0.3\text{nH}$	6	100	8.0	9.6	0.18	0.08	500	MLK1005S2N2STD25
2.4	$\pm 0.3\text{nH}$	6	100	7.8	9.5	0.20	0.09	500	MLK1005S2N4STD25
2.7	$\pm 0.3\text{nH}$	6	100	7.5	9.1	0.20	0.10	500	MLK1005S2N7STD25
3.0	$\pm 0.3\text{nH}$	6	100	7.2	8.5	0.22	0.10	400	MLK1005S3N0STD25
3.3	$\pm 0.3\text{nH}$	7	100	7.0	8.3	0.22	0.11	400	MLK1005S3N3STD25
3.6	$\pm 0.3\text{nH}$	7	100	6.8	8.1	0.25	0.11	400	MLK1005S3N6STD25
3.9	$\pm 0.3\text{nH}$	7	100	6.5	7.8	0.25	0.12	400	MLK1005S3N9STD25
4.3	$\pm 0.3\text{nH}$	7	100	6.3	7.4	0.28	0.13	400	MLK1005S4N3STD25
4.7	$\pm 0.3\text{nH}$	7	100	6.0	6.9	0.28	0.13	400	MLK1005S4N7STD25
5.1	$\pm 0.3\text{nH}$	7	100	5.8	7.0	0.30	0.15	400	MLK1005S5N1STD25
5.6	$\pm 0.3\text{nH}$	7	100	5.7	6.7	0.30	0.15	400	MLK1005S5N6STD25
6.2	$\pm 0.3\text{nH}$	7	100	5.6	6.5	0.35	0.18	400	MLK1005S6N2STD25
6.8	$\pm 5\%$	7	100	5.5	6.3	0.35	0.18	400	MLK1005S6N8JTD25
7.5	$\pm 5\%$	7	100	5.0	6.0	0.38	0.20	350	MLK1005S7N5JTD25
8.2	$\pm 5\%$	7	100	5.0	6.0	0.38	0.21	350	MLK1005S8N2JTD25
9.1	$\pm 5\%$	7	100	4.8	5.9	0.42	0.23	350	MLK1005S9N1JTD25
10	$\pm 5\%$	7	100	4.7	5.2	0.42	0.23	350	MLK1005S10NJTD25
12	$\pm 5\%$	7	100	4.3	5.3	0.47	0.27	350	MLK1005S12NJTD25
15	$\pm 5\%$	7	100	4.0	4.8	0.50	0.33	300	MLK1005S15NJTD25
18	$\pm 5\%$	7	100	4.0	4.7	0.60	0.38	250	MLK1005S18NJTD25
22	$\pm 5\%$	7	100	3.5	4.4	0.70	0.46	200	MLK1005S22NJTD25
27	$\pm 5\%$	7	100	3.0	3.9	0.80	0.53	200	MLK1005S27NJTD25
33	$\pm 5\%$	7	100	2.5	3.5	0.90	0.59	200	MLK1005S33NJTD25
39	$\pm 5\%$	6	100	2.0	3.1	1.00	0.65	200	MLK1005S39NJTD25
47	$\pm 5\%$	6	100	1.8	3.0	1.20	0.74	200	MLK1005S47NJTD25
56	$\pm 5\%$	6	100	1.5	2.6	1.30	0.84	200	MLK1005S56NJTD25
68	$\pm 5\%$	6	100	1.4	2.4	1.50	1.01	150	MLK1005S68NJTD25
82	$\pm 5\%$	6	100	1.3	2.2	1.80	1.39	150	MLK1005S82NJTD25
100	$\pm 5\%$	6	100	1.1	1.9	2.20	1.60	100	MLK1005SR10JTD25
110	$\pm 5\%$	6	100	1.1	2.0	2.70	1.89	100	MLK1005SR11JTD25
120	$\pm 5\%$	6	100	1.1	1.9	3.00	2.08	100	MLK1005SR12JTD25
130	$\pm 5\%$	6	100	1.1	1.8	3.30	2.28	100	MLK1005SR13JTD25
150	$\pm 5\%$	6	100	1.1	1.7	5.00	3.58	80	MLK1005SR15JTD25
160	$\pm 5\%$	6	100	1.1	1.7	5.20	3.79	80	MLK1005SR16JTD25
180	$\pm 5\%$	6	100	1.1	1.6	6.00	4.28	80	MLK1005SR18JTD25
200	$\pm 5\%$	6	100	1.1	1.5	6.20	4.56	70	MLK1005SR20JTD25
220	$\pm 5\%$	6	100	1.0	1.4	6.20	4.54	70	MLK1005SR22JTD25
240	$\pm 5\%$	6	100	1.0	1.3	6.50	4.84	70	MLK1005SR24JTD25
270	$\pm 5\%$	6	100	0.9	1.2	6.50	4.78	70	MLK1005SR27JTD25
300	$\pm 5\%$	6	100	0.9	1.2	7.50	5.37	70	MLK1005SR30JTD25
330	$\pm 5\%$	6	100	0.85	1.1	8.00	5.82	70	MLK1005SR33JTD25

○ Measurement equipment

Measurement item	Product No.	Manufacturer
L, Q	4291B+16193A	Agilent Technologies
Self-resonant frequency	8720C	Agilent Technologies
DC resistance	Type-7561	Yokogawa

* Equivalent measurement equipment may be used.

• All specifications are subject to change without notice.

MLK series **MLK1005 Type**

■ ELECTRICAL CHARACTERISTICS

□ L, Q FREQUENCY CHARACTERISTICS TABLE

L(nH)typ.					Q typ.					Part No.
500MHz	800MHz	1.8GHz	2.0GHz	2.4GHz	500MHz	800MHz	1.8GHz	2.0GHz	2.4GHz	
0.9	0.9	0.9	0.9	0.9	16	20	30	32	36	MLK1005S1N0STD25
1.0	1.0	1.0	1.0	1.0	16	20	32	35	39	MLK1005S1N1STD25
1.1	1.1	1.1	1.1	1.1	15	18	28	30	33	MLK1005S1N2STD25
1.2	1.2	1.2	1.2	1.2	17	20	33	35	39	MLK1005S1N3STD25
1.4	1.4	1.4	1.4	1.4	15	19	29	31	34	MLK1005S1N5STD25
1.5	1.5	1.5	1.5	1.5	17	21	34	36	40	MLK1005S1N6STD25
1.7	1.7	1.7	1.7	1.7	16	21	32	33	37	MLK1005S1N8STD25
1.9	1.8	1.9	1.9	1.9	16	20	32	34	38	MLK1005S2N0STD25
2.0	2.0	2.0	2.0	2.1	15	19	29	31	34	MLK1005S2N2STD25
2.2	2.2	2.2	2.3	2.3	16	20	32	34	38	MLK1005S2N4STD25
2.5	2.5	2.5	2.6	2.6	17	22	33	35	39	MLK1005S2N7STD25
2.8	2.8	2.8	2.9	2.9	18	22	35	36	41	MLK1005S3N0STD25
3.1	3.1	3.1	3.1	3.2	16	20	31	32	36	MLK1005S3N3STD25
3.4	3.3	3.4	3.5	3.5	17	22	33	35	39	MLK1005S3N6STD25
3.7	3.6	3.7	3.7	3.8	17	21	32	33	37	MLK1005S3N9STD25
4.0	4.0	4.1	4.2	4.3	17	22	34	35	39	MLK1005S4N3STD25
4.4	4.4	4.5	4.6	4.7	17	22	33	35	38	MLK1005S4N7STD25
4.8	4.8	4.9	5.0	5.1	17	22	33	35	38	MLK1005S5N1STD25
5.3	5.2	5.4	5.5	5.7	17	22	33	34	38	MLK1005S5N6STD25
5.8	5.8	6.0	6.2	6.4	18	23	34	35	39	MLK1005S6N2STD25
6.4	6.4	6.6	6.7	7.0	17	22	32	33	36	MLK1005S6N8JTD25
7.1	7.0	7.4	7.6	7.9	18	23	34	36	38	MLK1005S7N5JTD25
7.7	7.7	8.1	8.3	8.6	19	23	34	36	38	MLK1005S8N2JTD25
8.6	8.6	9.1	9.3	9.7	18	23	34	36	38	MLK1005S9N1JTD25
9.4	9.4	10.0	10.2	10.7	19	23	34	35	38	MLK1005S10N1JTD25
11.3	11.3	12.1	12.4	13.0	19	23	34	35	37	MLK1005S12N1JTD25
14.2	14.2	15.3	15.8	16.8	18	23	33	34	35	MLK1005S15N1JTD25
17.0	17.1	18.6	19.2	20.6	18	23	32	33	34	MLK1005S18N1JTD25
20.8	20.9	23.0	23.9	25.8	18	23	32	33	34	MLK1005S22N1JTD25
25.6	25.9	29.8	31.5	35.7	18	23	30	30	28	MLK1005S27N1JTD25
31.4	31.9	37.6	40.2		18	23	29	29		MLK1005S33N1JTD25
37.2	38.1	48.9			17	21	24			MLK1005S39N1JTD25
45.0	46.2	60.6			18	21	24			MLK1005S47N1JTD25
53.7	55.4	76.7			17	21	22			MLK1005S56N1JTD25
65.5	68.4	105.6			17	20	18			MLK1005S68N1JTD25
79.3	83.6	142.7			16	19	15			MLK1005S82N1JTD25
97.1	103.2	199.4			15	18	13			MLK1005SR10JTD25
107.8	115.9				16	18				MLK1005SR11JTD25
118.0	127.8				16	18				MLK1005SR12JTD25
127.5	139.5				14	16				MLK1005SR13JTD25
149.4	166.0				16	17				MLK1005SR15JTD25
160.5	179.4				16	18				MLK1005SR16JTD25
181.1	204.1				16	17				MLK1005SR18JTD25
202.8	231.9				15	17				MLK1005SR20JTD25
225.7	266.8				15	15				MLK1005SR22JTD25
248.3	299.6				14	15				MLK1005SR24JTD25
290.0	386.0				14	12				MLK1005SR27JTD25
323.1	432.6				14	12				MLK1005SR30JTD25
358.9	493.1				13	12				MLK1005SR33JTD25

○ Measurement equipment

Product No.	Manufacturer
4291B+16193A	Agilent Technologies

* Equivalent measurement equipment may be used.

• All specifications are subject to change without notice.

MLK series MLK1005 Type

ELECTRICAL CHARACTERISTICS

L FREQUENCY CHARACTERISTICS GRAPH (EXAMPLE)

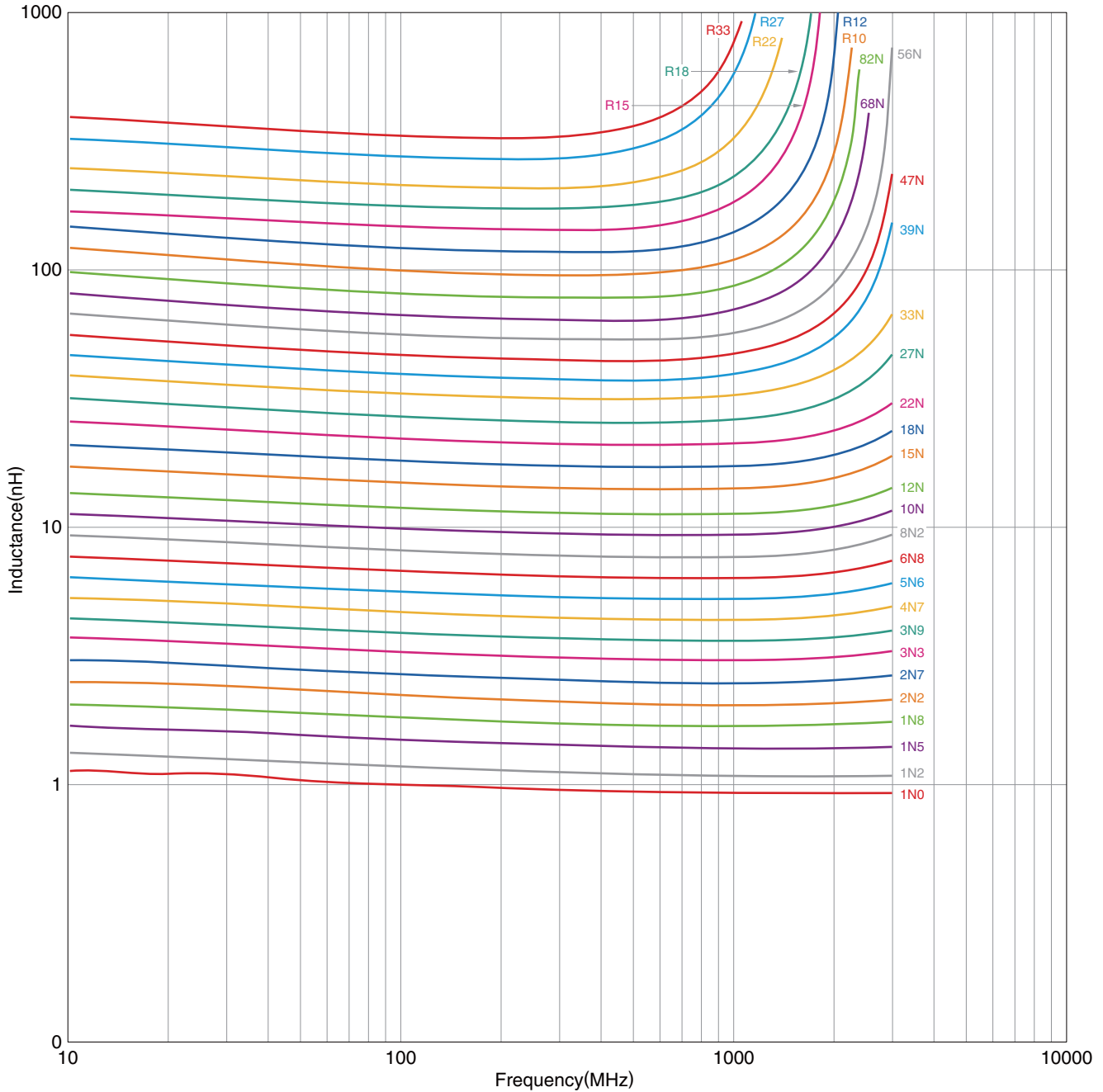

○ Measurement equipment

Product No.	Manufacturer
E4991A+16193A	Agilent Technologies

* Equivalent measurement equipment may be used.

• All specifications are subject to change without notice.

MLK series **MLK1005 Type**

■ ELECTRICAL CHARACTERISTICS

□ Q FREQUENCY CHARACTERISTICS GRAPH (EXAMPLE)

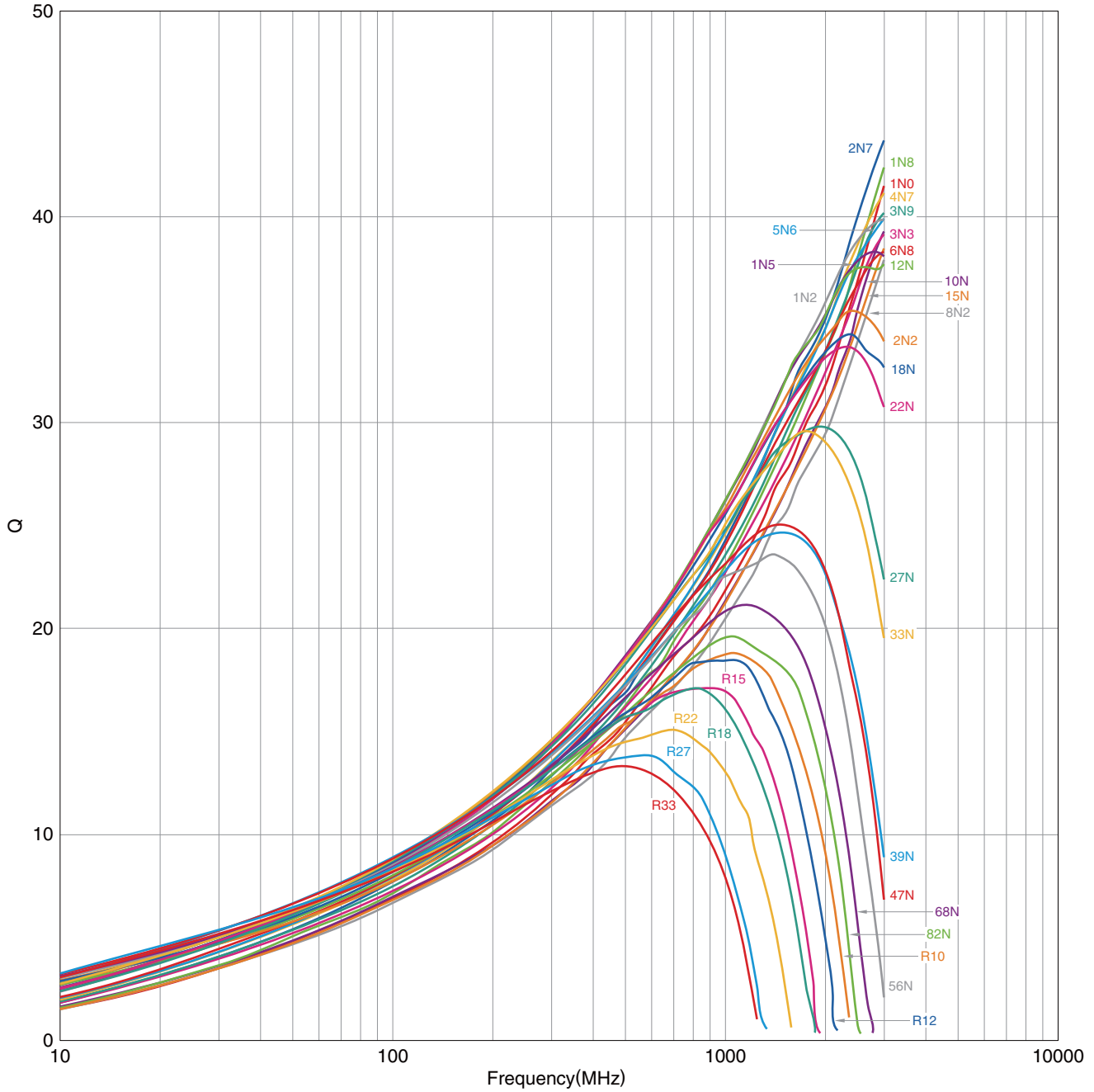

○ Measurement equipment

Product No.	Manufacturer
E4991A+16193A	Agilent Technologies

* Equivalent measurement equipment may be used.

• All specifications are subject to change without notice.

MLK series

Packaging Style

REEL DIMENSIONS

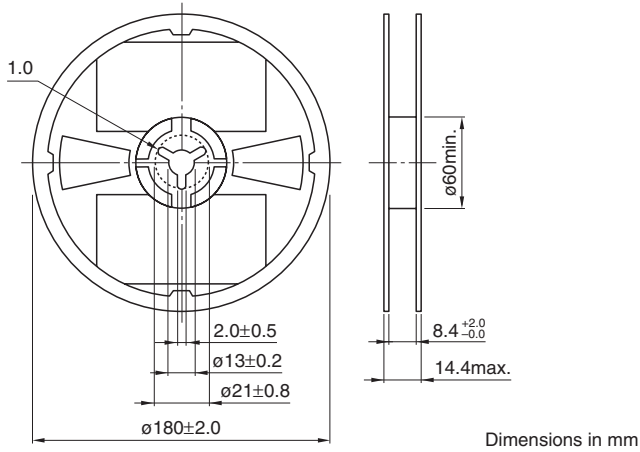

TAPE DIMENSIONS

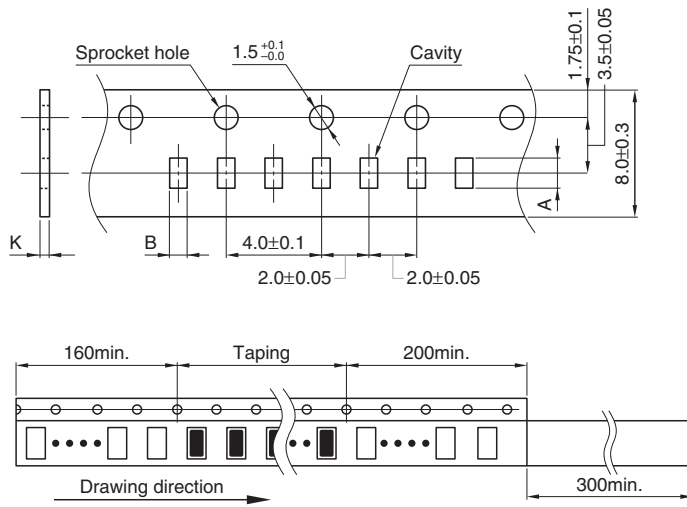

Type	A	B	K
MLK1005	1.15±0.1	0.67±0.1	0.8 max.

• All specifications are subject to change without notice.