

THIS DRAWING IS UNPUBLISHED. RELEASED FOR PUBLICATION 27-02-02 .- .
 © COPYRIGHT 2002 By - ALL RIGHTS RESERVED.

LOC		DIST		REVISIONS			
GP	00	P	LTR	DESCRIPTION	DATE	DWN	APVD
		N		REVISED PER ECO-13-000397	31JAN2013	CJV	CWR

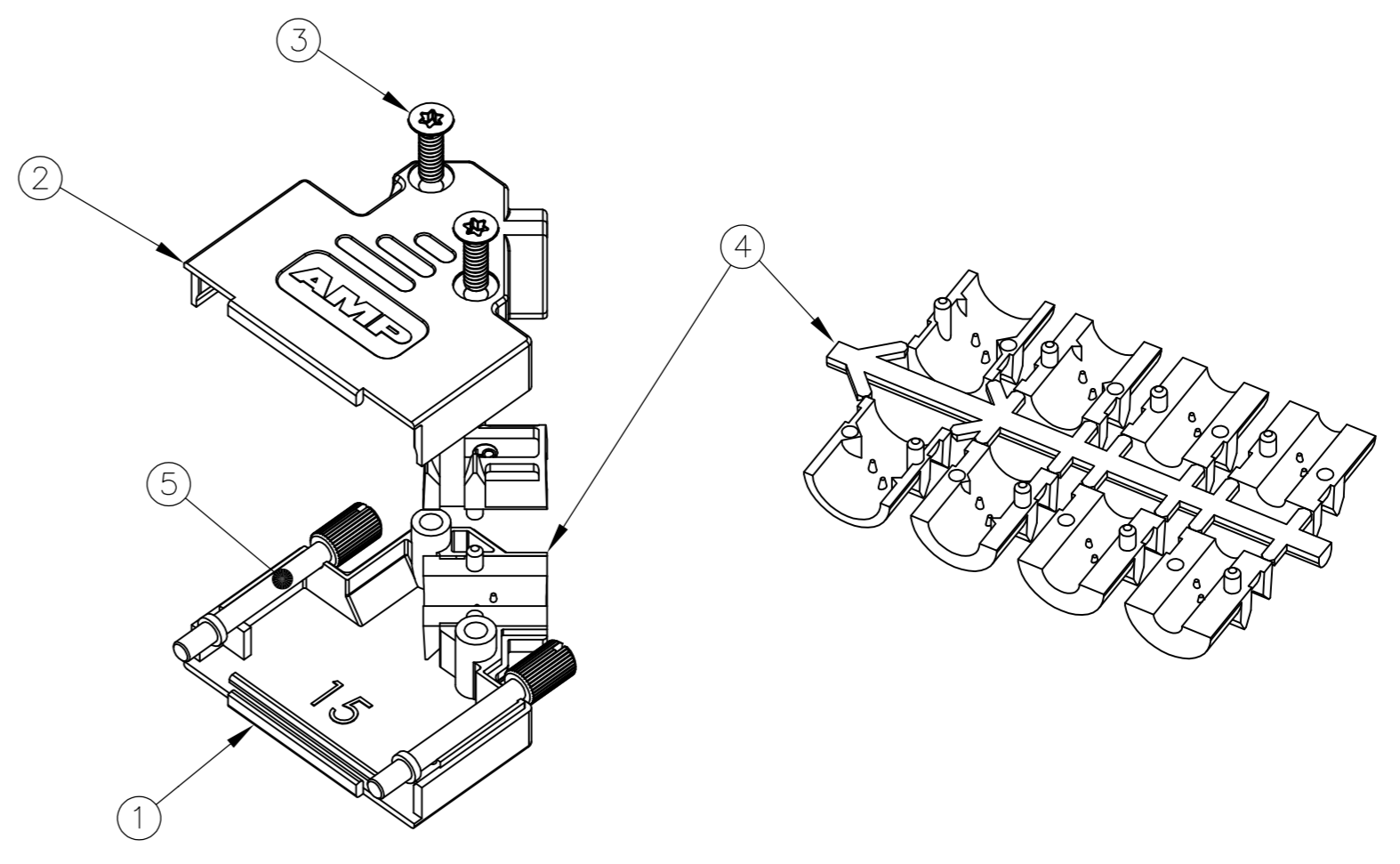
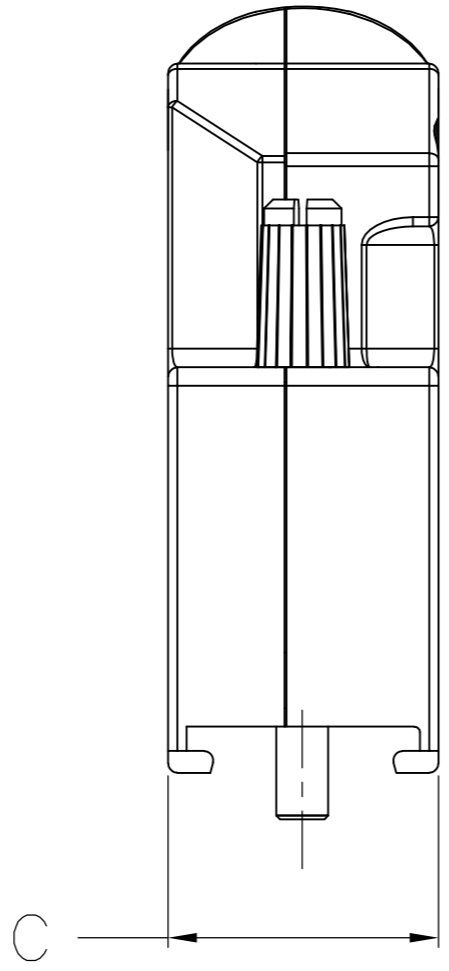
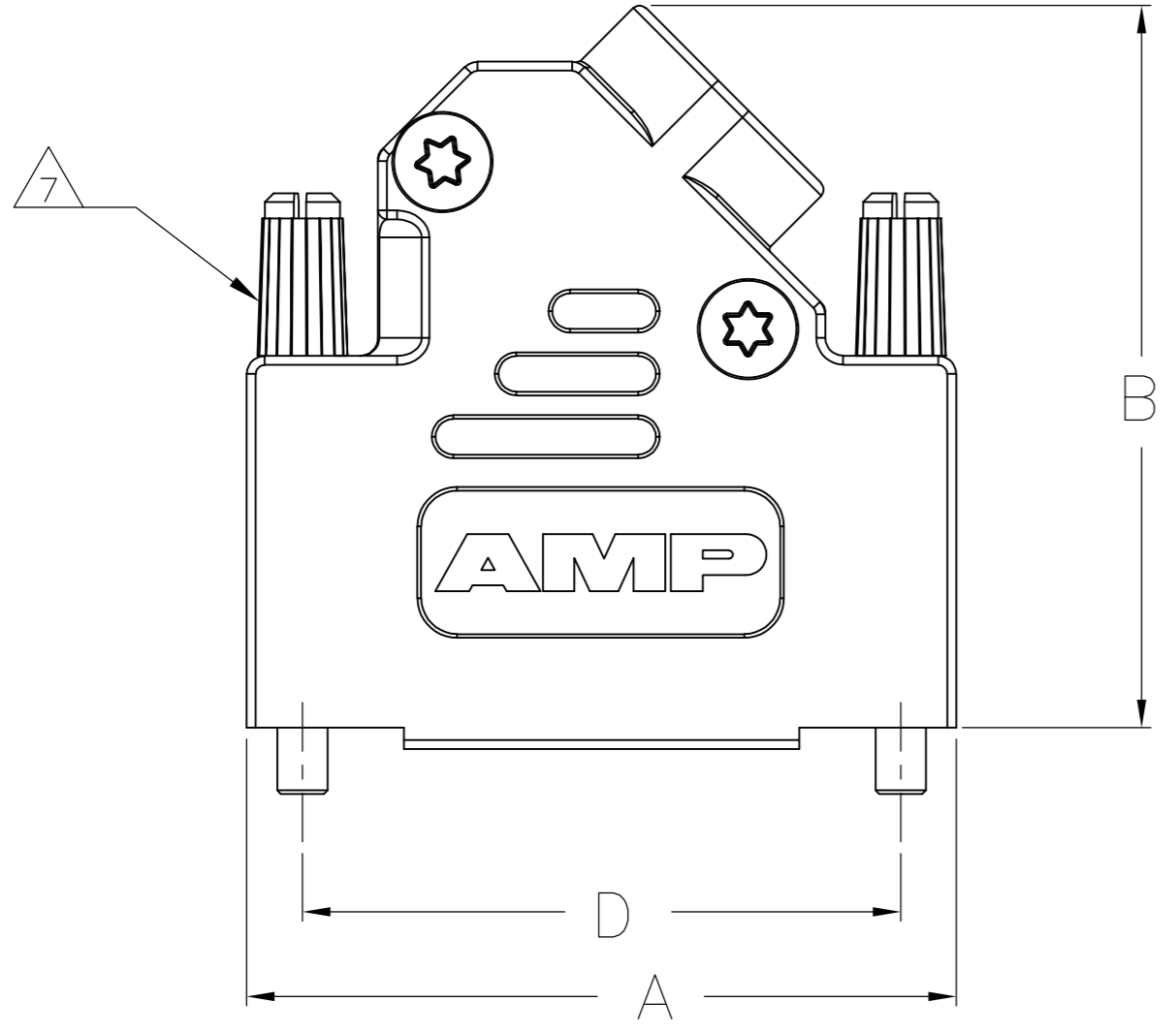

- 1. FOR ASSEMBLY DETAILS, REFER TO LEAFLET 2227518-1.
- 2. BULK PACKAGED BACKSHELL ASSEMBLIES: ITEM 1, 100 PCS LOOSE IN BOX. ITEMS 2 THRU 5, 100 TIMES QTY SHOWN IN TABLE IN 1 BAG FOR EACH ITEM. ALL BAGS IN 1 BOX WITH (1) 2227518-1 LEAFLET.
- 3. INDIVIDUALLY PACKAGED SHELL ASSEMBLIES: 1 BAG CONTAINS ALL COMPONENTS FOR 1 COMPLETE ASSEMBLY. 100 BAGS PER BOX, (1) 2227518-1 LEAFLET PER BOX.
- 4. TERMINATES 4.0-13.0 CABLE DIAMETERS.
- 5. 15 POSITION SHOWN.
- 6. TRIVALENT CHROMIUM CHROMATE COATING OVER ZINC PLATING.

- 7. JACKSCREW QUANTITY:
 9 WAY ASSEMBLY: 1 JACKSCREW
 15 WAY ASSEMBLY: 2 JACKSCREWS
 25 WAY ASSEMBLY: 2 JACKSCREWS
 37 WAY ASSEMBLY: 2 JACKSCREWS
- 8. OPTIONAL CABLE CRIMP KIT AVAILABLE FOR 6.0-9.5 DIAMETER CABLE. SEE 1478764

3	63.5	14.6	40.2	69.7	TORX	4-40 UNC	4	37 WAY	5-1478763-4
3	47.0	14.6	40.2	53.2	TORX	4-40 UNC	3	25 WAY	5-1478763-3
3	33.3	14.6	40.2	39.5	TORX	4-40 UNC	2	15 WAY	5-1478763-2
3	25.0	14.6	36.2	31.0	TORX	4-40 UNC	1	9 WAY	5-1478763-1
2	47.0	14.6	40.2	53.2	TORX	M3	3	25 WAY	4-1478763-7
2	33.3	14.6	40.2	39.5	TORX	M3	2	15 WAY	4-1478763-6
2	25.0	14.6	36.2	31.0	TORX	M3	1	9 WAY	4-1478763-5
2	63.5	14.6	40.2	69.7	TORX	4-40 UNC	4	37 WAY	3-1478763-7
2	47.0	14.6	40.2	53.2	TORX	4-40 UNC	3	25 WAY	2-1478763-5
2	33.3	14.6	40.2	39.5	TORX	4-40 UNC	2	15 WAY	1-1478763-5
2	25.0	14.6	36.2	31.0	TORX	4-40 UNC	1	9 WAY	1478763-9
PACKAGING	D	C	B	A	SELF TAPPING FIXING SCREW TYPE	JACKSCREW THREAD	SHELL SIZE	POSITION	PART NUMBER

5	JACKSCREW ASSEMBLY	POLYAMIDE, UL94 V2 KNOB CARBON STEEL SHAFT	BLACK 6	7
4	STRAIN RELIEF SET	POLYCARBONATE UL94 V0	BLACK	1
3	SELF TAPPING FIXING SCREW	CARBON STEEL	6	2
2	TOP BACKSHELL	ZINC	NICKEL	1
1	BOTTOM BACKSHELL	ZINC	NICKEL	1
ITEM	DESCRIPTION	MATERIAL	FINISH	QTY

THIS DRAWING IS A CONTROLLED DOCUMENT. DIMENSIONING AND TOLERANCING PER ASME Y14.5M-2009

DWN C. VALENTINE 06JAN2011
 CHK C. ROHDE 06JAN2012
 APVD C. ROHDE 06JAN2012

TE Connectivity
 ADK SERIES DIE-CAST BACKSHELL 45 DEGREE ENTRY

SIZE A2 CAGE CODE 00779 C=1478763
 SCALE NTS SHEET 1 OF 1 REV N

TOLERANCES UNLESS OTHERWISE SPECIFIED:
 0 PLC ± 0.5
 1 PLC ± 0.5
 2 PLC ± 0.5
 3 PLC ± 0.5
 4 PLC ± 0.5
 ANGLES ± -

MATERIAL SEE TABLE FINISH -

CUSTOMER DRAWING

Mouser Electronics

Authorized Distributor

Click to View Pricing, Inventory, Delivery & Lifecycle Information:

[TE Connectivity:](#)

[5-1478763-3](#)