



DEUTSCH

BRANCHE CONNECTEURS AEROMILITAIRES



AFD series Norme MIL-C 26482 G

Series 2

Introduction	1
Advantage	2
Technical characteristics	3
Part-numbering system	4
Standard equivalence	5
Synoptic	6
Arrangements	8
Receptacles	10
Plugs	14
Large receptacles	18
Mating and unmating dimensions	21
Accessories	22
Protective covers	24
Contacts and tools	26
Contacts and tools for coax	28
Bushings	30
Part-numbering system hermetic	31
Hermetic receptacles	33



- 1** – Triple wire seal.
- 2** – Mechanical retention of insert into shell by means of snap ring.
- 3** – Interfacial seal ensured by compression of insert and static / dynamic seal.
- 4** – Contacts individual sealing at coupling stage by compression of elastomer conical risers on hard insert.
- 5** – Anti-friction washers for constant mating force.
- 6** – Insert to shell sealing with potting.
- 7** – Connector's rear part fitted with a teeth anti-rotation system assuming an effective tightening and clamping.

Representing the most advanced design in use which both reflects and sets the pace for future developments, Compagnie DEUTSCH presents its AFD series connectors meet requirements of MIL-C 26482 G series 2 bayonet coupling connectors.

The Compagnie DEUTSCH AFD series connectors offer several advantages over previous devices such as :

- Higher performance characteristics.
- Completely sealed against rigorous environments.
- Reduced assembly and rework costs.
- Simplified assembly procedures.
- Hard plastic socket interface prevents penetration of bent pins.
- Rear release system from the rear of the connector.
- RFI fingers available for AFD 57 only.
- Intermateability and interchangeability with Compagnie DEUTSCH series connectors :
 - 951 meet requirements of NFL 54125 B and UTE 93422 model HE 301 B.
 - FDDB meet requirements of MIL-C 26482 and UTE 93422 model HE 302 and 303.
- Available in 9 shell sizes and 27 various insert arrangements.
- Hermetically sealed electrical connectors in DBC version.

Mechanical

Shell and accessoires	Material Plating	: Aluminum alloy : Nickel, standard, corrosion test as per MIL - STD 1344 Modifications index olive drab cadmium
Silicone insert	Material Resistance	: Front and rear silicone inserts are devoid of all organic matter : Withstands fluids to MIL-C 26482 G standard
Contact	Type Finish	: Crimp type : Gold over nickel
Durability		: 500 full coupling and uncoupling cycles 250 RFI fingers cycles
Contact Retention		Contacts withstand a minimum load of : Size 20 : 6,93 daN Size 16 : 11,56 daN Size 12 : 11,56 daN Size 8 : 11,56 daN
Temperature		: - 55° C to + 200° C
Air Leakage		: Leakage inferior to 16 cm ³ /hour under a 2,1 bars differential pressure
Thermal Shocks		: 5 cycles of - 55° C to + 200° C
Vibrations		: No mechanical nor electrical failure further to 12 hours vibration (4 hours in the 3 axes), 20 G from 10 to 2000 Hz
Physical Shocks		: 100 G 11 ms in the 3 axes

Electrical

Withstanding voltage	at sea level	: Service 1 : 1500 V 50 Hz (R.M.S) Service 2 : 2300 V 50 Hz (R.M.S)
	at 15000 m altitude	: Service 1 : 500 V Service 2 : 750 V
	at 21000 m altitude	: Service 1 : 375 V Service 2 : 500 V
	at 33000 m altitude	: Service 1 : 200 V Service 2 : 200 V
	Insulation resistance	: Higher than 5000 MΩ at 25° C at 60% R.H.
Contacts maximum current		: Size 20 : 7,5 A. Size 16 : 13 A. Size 12 : 23 A. Size 8 : 46 A.
Contact millivolt drop		: Size 20 : 15 mv at 7,5 A. Size 16 : 21 mv at 13 A. Size 12 : 22 mv at 23 A. Size 8 : 25 mv at 23 A.
Allowed wires section		: Size 20 : 0,21 to 0,60 mm ² Size 16 : 0,60 to 1,34 mm ² Size 12 : 1,91 to 3,18 mm ² Size 8 : 5,30 to 8,98 mm ²
Diameter over insulating sheath		: Size 20 : 1,01 to 2,10 mm Size 16 : 1,73 to 2,62 mm Size 12 : 2,69 to 4,01 mm Size 8 : 3,80 to 5,15 mm



Connectors weight in grams

Size	AFD 50 Shell and contacts without backshell		AFD 54 Shell and contacts without backshell		AFD 56/57 Shell and contacts without backshell		Accessories weight		
	Male	Female	Male	Female	Male	Female	Backshell	Straight cable clamp	90° end bell cable clamp
8-3A	7,60*	8,00	10,80*	11,20	10,00	10,40	2,44	6,50	8,35
10-06	11,50	12,30	14,50	15,20	14,70	15,50	5,49	7,90	10,10
12-10	14,50	15,20*	20,90	21,60	20,10	20,80	6,48	7,70	11,70
14-19	18,00	19,50*	25,80*	27,30	22,50	24,00	7,48	9,90	15,20
16-26	23,10	25,70*	31,50	34,10*	28,70	31,30	8,99	12,00	16,50
18-32	26,10*	29,00	37,60*	40,50	34,00	36,90	10,97	13,70	20,35
20-41	32,20*	36,20	49,10	53,10*	39,70	43,70	11,97	15,00	24,90
22-55	39,80*	44,00	56,80*	61,00	46,00	50,20	13,97	17,10	26,20
24-61	49,50*	56,00	65,50*	72,00	53,10	61,20	15,16	18,50	34,70

* Calculated value

Contacts weight in grams

Taille	Type	Reference	Weight in grams
20	P	006-0937-20-A	0,25
	S	006-0912-20	0,28
16	P	006-0937-16-A	0,56
	S	006-0912-16	0,61
12	P	006-0937-12-A	1,23
	S	006-0912-12	1,22
08	P	005-0893-08	3,18
	S	005-0896-08	2,90
Coax.	P	005-0920-00	6,68
	S	005-0921-00	6,88

Connectors

Reference MIL-C 83723	Reference MS 3470	Reference Panavia 6432	Reference Deutsch	Finish
-	-	PAN 6432-1B-**-P/N	AFD 50-**-P/N A 5324	Olive drab cadmium
-	MS 3470-W-**-P/N	-	AFD 50-**-P/N A 5727	Olive drab cadmium
M 83723-02-R-**-N	MS 3470-L-**-P/N	-	AFD 50-**-P/N A 5730	Nickel plating
M 83723-02-A-**-N	-	-	AFD 50-**-P/N 6116	Black anodized
-	-	PAN 6432-1B-**-P/N	AFD 50-**-S/N A 5324	Olive drab cadmium
-	MS 3470-W-**-S/N	-	AFD 50-**-S/N A 5727	Olive drab cadmium
M 83723-01-R-**-N	MS 3470-L-**-S/N	-	AFD 50-**-S/N A 5730	Nickel plating
M 83723-01-A-**-N	-	-	AFD 50-**-S/N 6116	Black anodized
-	MS 3472-W-**-P/N	-	AFD 58-**-P/N A 5727	Olive drab cadmium
M 83723-04-R-**-N	MS 3472-L-**-P/N	-	AFD 58-**-P/N A 5730	Contacts with 3 color bands
M 83723-04-A-**-N	-	-	AFD 58-**-P/N 6116	Black anodized
-	MS 3472-W-**-S/N	-	AFD 58-**-S/N A 5727	Olive drab cadmium
M 83723-03-R-**-N	MS 3472-L-**-S/N	-	AFD 58-**-S/N A 5730	Nickel plating
M 83723-03-A-**-N	-	-	AFD 58-**-S/N 6116	Black anodized
-	-	PAN 6432-1A-**-P/N	AFD 54-**-P/N A 5324	Olive drab cadmium
-	MS 3474-W-**-P/N	-	AFD 54-**-P/N A 5727	Olive drab cadmium
M 83723-06-R-**-N	MS 3474-L-**-P/N	-	AFD 54-**-P/N A 5730	Nickel plating
M 83723-06-A-**-N	-	-	AFD 54-**-P/N 6116	Black anodized
-	-	PAN 6432-1A-**-S/N	AFD 54-**-S/N A 5324	Olive drab cadmium
-	MS 3474-W-**-S/N	-	AFD 54-**-S/N A 5727	Olive drab cadmium
M 83723-05-R-**-N	MS 3474-L-**-S/N	-	AFD 54-**-S/N A 5730	Nickel plating
M 83723-05-A-**-N	-	-	AFD 54-**-S/N 6116	Black anodized
-	MS 3471-W-**-P/N	-	AFD 51-**-P/N A 5727	Olive drab cadmium
M 83723-08-R-**-N	MS 3471-L-**-P/N	-	AFD 51-**-P/N A 5730	Nickel plating
M 83723-08-A-**-N	-	-	AFD 51-**-P/N 6116	Black anodized
-	MS 3471-W-**-S/N	-	AFD 51-**-S/N A 5727	Olive drab cadmium
M 83723-07-R-**-N	MS 3471-L-**-S/N	-	AFD 51-**-S/N A 5730	Nickel plating
M 83723-07-A-**-N	-	-	AFD 51-**-S/N 6116	Black anodized
-	-	PAN 6432-1F-**-P/N	AFD 56-**-P/N A 5324	Olive drab cadmium
-	MS 3476-W-**-P/N	-	AFD 56-**-P/N A 5727	Olive drab cadmium
M 83723-14-R-**-N	MS 3476-L-**-P/N	-	AFD 56-**-P/N A 5730	Nickel plating
M 83723-14-A-**-N	-	-	AFD 56-**-P/N 6116	Black anodized
-	-	PAN 6432-1F-**-S/N	AFD 56-**-S/N A 5324	Olive drab cadmium
-	MS 3476-W-**-S/N	-	AFD 56-**-S/N A 5727	Olive drab cadmium
MS 83723-13-R-**-N	MS 3476-L-**-S/N	-	AFD 56-**-S/N A 5730	Nickel plating
MS 83723-13-A-**-N	-	-	AFD 56-**-S/N 6116	Black anodized
-	MS 3475-W-**-P/N	-	AFD 57-**-P/N A 5727	Olive drab cadmium
M 83723-42-R-**-N	MS 3475-L-**-P/N	-	AFD 57-**-P/N A 5730	Nickel plating
M 83723-42-A-**-N	-	-	AFD 57-**-P/N 6116	Black anodized
-	MS 3475-W-**-S/N	-	AFD 57-**-S/N A 5727	Olive drab cadmium
M 83723-43-R-**-N	MS 3475-L-**-S/N	-	AFD 57-**-S/N A 5730	Nickel plating
M 83723-43-A-**-N	-	-	AFD 57-**-S/N 6116	Black anodized

Rear accessories

Ms Nickel Reference	Nickel plated		Olive drab cadmium	
	Deutsch Nickel Reference		MS olive drab cadmium Reference	Deutsch olive drab cadmium Reference
Backshell MS 3416-**-EN	94002-**-3014		MS 3416-**-EC	94002-**- A 231
Straight cable clamp MS 3417-**-N	94003-**-3014		MS 3417-**-C	94003-**-A 231
90° end bell cable clamp MS 3418-**-N	94004-**-3014		MS 3418-**-C	94004-**- A 231

Contacts

Size	Type	Reference norm	Deutsch reference to be ordered
20	P	M 39029/4-110	006-0937-20-A 834
	S	M 39029/5-115	006-0912-20-A 834
16	P	M 39029/4-111	006-0937-16-A 834
	S	M 39029/5-116	006-0912-16-A 834
16	P	M 39029/4-112	006-1168-16-A 834
	S	M 39029/5-117	006-1169-16-A 834
12	P	M 39029/4-113	006-0937-12-A 834
	S	M 39029/5-118	006-0912-12-A 834
12	P	M 39029/4-114	006-1157-12-A 834
	S	M 39029/5-119	006-1159-12-A 834

■ Accessories

■ Receptacles

■ Plugs

■ Accessories



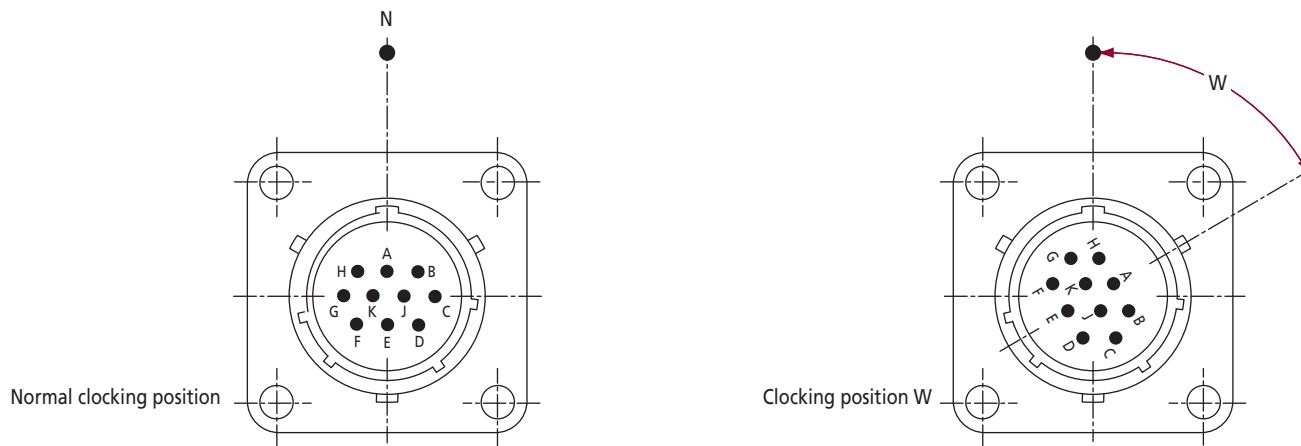

Example of insert angular displacement, pin front face view

Clocking position is normal when the insert vertical axis is intermingled with the shell keyway axis. An unkeying can be performed between 2 connectors of same layout by angular displacement of one of the inserts in its shell. This insert rotation is made in the clockwise for pin layouts and in the counter clockwise for socket layouts. Angular displacements on the hereafter table give clocking positions W, X, Y or Z.

Insert Arrangt.	Clocking position in degrees				Contacts sizes						
	w	x	y	z	20	16	12	8 or Coax	Standard	Hermetic	Serv
08-3A	60	-	-	-	3	-	-	-	1	1	I
08-33	90	-	-	-	3	-	-	-	1	1	I
8-98	60	210	-	-	3	-	-	-	1	1	I
10-6	90	-	-	-	6	-	-	-	1	1	I
12-3	-	-	180	-	-	3	-	-	1	1	II
12-8	90	112	203	292	8	-	-	-	1	-	I
12-10	60	155	270	295	10	-	-	-	1	1	I
14-4	-	-	-	-	-	-	4	-	1	1	I
14-5	40	92	184	273	-	5	-	-	1	1	II
14-12	43	90	-	-	8	4	-	-	1	1	I
14-15	17	110	155	234	14	1	-	-	1	1	I
14-18	15	90	180	270	18	-	-	-	1	1	I
14-19	30	165	315	-	19	-	-	-	1	1	I
16-8	54	152	180	331	-	8	-	-	1	1	II
16-26	60	105	275	338	26	-	-	-	1	1	I
18-8	-	-	-	-	-	-	8	-	1	1	I
18-11	62	119	241	340	-	11	-	-	1	-	II
18-32	85	138	222	265	32	-	-	-	1	1	I
18-918	-	-	-	-	16	-	-	2	1	-	I
20-16	238	318	333	347	-	16	-	-	1	1	II
20-39	63	144	252	333	37	2	-	-	1	1	I
20-41	45	126	225	-	41	-	-	-	1	1	I
22-12	-	-	-	-	-	-	12	-	1	-	I
22-21	16	135	175	349	-	21	-	-	1	-	II
22-32	72	145	215	288	32	-	-	-	1	-	I
22-41	39	135	264	-	27	14	-	-	1	1	I
22-55	30	142	226	314	55	-	-	-	1	1	I
24-19	30	165	315	-	-	-	19	-	1	-	II
24-31	90	225	-	-	-	31	-	-	1	-	I
24-37	25	50	75	-	-	37	-	-	1	-	I
24-53	-	-	-	-	51	-	-	2	1	-	I
24-61	90	180	270	324	61	-	-	-	1	1	I
24-100	45	90	135	-	-	-	-	10	-	-	I

Male insert, front face view or female insert, wiring side view.



Disposition 08-3A
3 contacts size 20



Disposition 08-33
3 contacts size 20



Disposition 08-98
3 contacts size 20

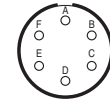

Disposition 10-6
6 contacts size 20



Disposition 12-3
3 contacts size 16



Disposition 12-8 *
8 contacts size 20



Disposition 12-10
10 contacts size 20

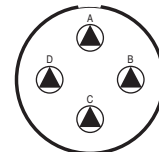

Disposition 14-4
4 contacts size 12



Disposition 14-5
5 contacts size 16



Disposition 14-12
8 contacts size 20
4 contacts size 16



Disposition 14-15
14 contacts size 20
1 contact size 16

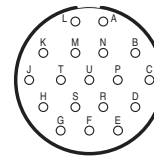

Disposition 14-18 *
18 contacts size 20

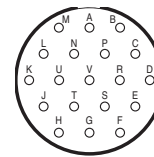

Disposition 14-19
19 contacts size 20



Disposition 16-8
8 contacts size 16



Disposition 16-26
26 contacts size 20



Disposition 18-8
8 contacts size 12

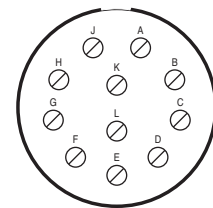

Disposition 18-11
11 contacts size 16

* Consult us

Male insert, front face view or female insert, wiring side view.



Disposition 18-32
32 contacts size 20



Disposition 18-918 *
16 contacts size 20
2 contacts size 8 or coax



Disposition 20-16
16 contacts size 16

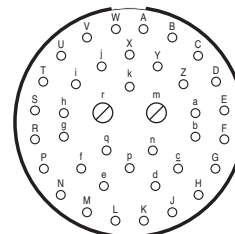

Disposition 20-39
37 contacts size 20
2 contacts size 16

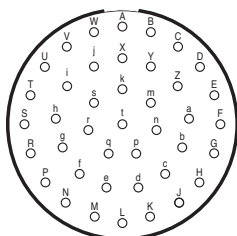

Disposition 20-41 *
41 contacts size 20

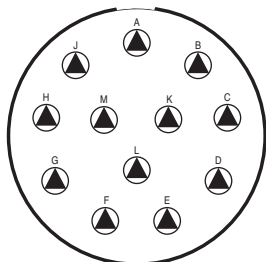

Disposition 22-12
12 contacts size 12

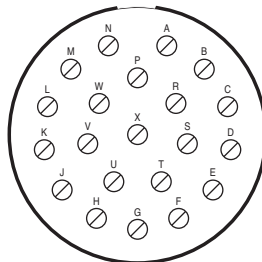

Disposition 22-21 *
21 contacts size 16

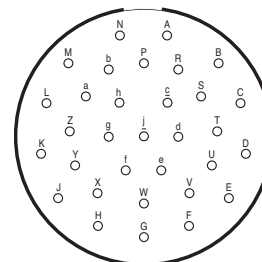

Disposition 22-32 *
32 contacts size 20

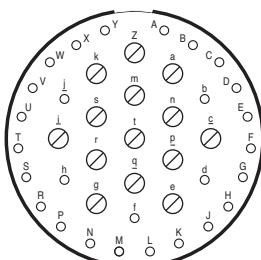

Disposition 22-41
27 contacts size 20
14 contacts size 16

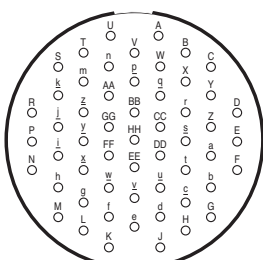

Disposition 22-55
55 contacts size 20

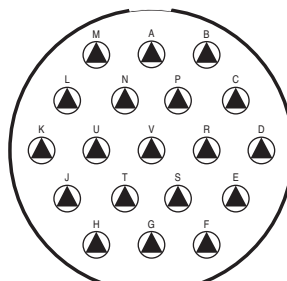

Disposition 24-19
19 contacts size 12

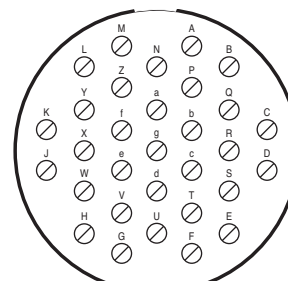

Disposition 24-31
31 contacts size 16

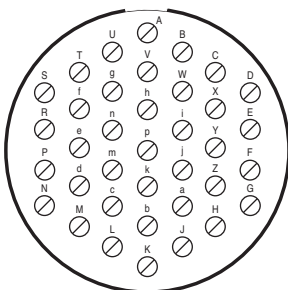

Disposition 24-37 *
37 contacts size 16



Disposition 24-53 *
51 contacts size 20
2 coax or size 8



Disposition 24-61
61 contacts size 20



Disposition 24-100 *
10 coax or size 8

* Consult us

Square flange



With backshell
Nickel plating without Mod.
Olive drab cadmium plating Mod. A 231



Without backshell
Nickel plating Mod. 1A
Olive drab cadmium plating Mod. A 5324



Nickel Plating Reference	B max.	C ± 0,1	D ± 0,15	E max.	F max.	G max.	G1 max.	L max.	L1 max.	P max.	Olive Drab Cadmium Plating Reference
AFD 50-08-**-P/S-*	21,00	15,08	11,13	1,95	12,03	15,65	12,70	36,85	30,85	7,75	AFD 50-08-**-P/S-*
AFD 50-10-**-P/S-*	24,20	18,26	11,13	1,95	15,01	18,60	15,85	36,85	30,85	10,29	AFD 50-10-**-P/S-*
AFD 50-12-**-P/S-*	26,55	20,62	11,13	1,95	19,07	21,75	19,05	36,85	30,85	13,49	AFD 50-12-**-P/S-*
AFD 50-14-**-P/S-*	28,95	23,02	11,13	1,95	22,24	24,95	22,20	36,85	30,85	16,89	AFD 50-14-**-P/S-*
AFD 50-16-**-P/S-*	31,30	24,58	11,13	1,95	25,42	28,20	25,40	36,85	30,85	20,07	AFD 50-16-**-P/S-*
AFD 50-18-**-P/S-*	33,70	26,98	11,13	1,95	28,60	30,90	26,95	36,85	30,85	22,07	AFD 50-18-**-P/S-*
AFD 50-20-**-P/S-*	36,85	29,36	14,30	2,55	31,77	34,15	30,15	38,40	32,35	25,25	AFD 50-20-**-P/S-*
AFD 50-22-**-P/S-*	39,95	31,76	14,30	2,55	34,94	37,25	33,30	38,40	32,35	28,42	AFD 50-22-**-P/S-*
AFD 50-24-**-P/S-*	43,15	34,92	15,10	2,55	38,12	40,45	36,50	38,40	32,35	31,60	AFD 50-24-**-P/S-*

Mounting styles

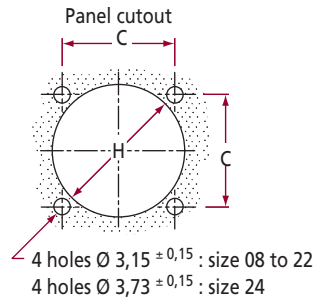

Size	C ± 0,1	H +0 -0,2	E max.
08	15,08	16,05	2,50
10	18,26	19,00	2,50
12	20,62	22,25	2,50
14	23,02	25,40	2,50
16	24,58	28,60	2,50
18	26,98	31,75	2,50
20	29,36	34,90	5,40
22	31,76	38,10	5,40
24	34,92	41,30	5,40

Flat gasket for square flange

To order apart



Front Flange Mounting					Rear Flange Mounting				
Size	Reference	H max.	B max.	C ± 0,1	E max.	H max.	Reference	Size	
08	108-0003-08-A 624	12,50	21,00	15,08	2,50	13,20	108-0001-08-A 624	08	
10	108-0003-10-A 624	15,40	24,20	18,26	2,50	16,40	108-0001-10-A 624	10	
12	108-0001-12-A 624	19,50	26,55	20,62	2,50	19,50	108-0001-12-A 624	12	
14	108-0001-14-A 624	22,70	28,95	23,02	2,50	22,70	108-0001-14-A 624	14	
16	108-0001-16-A 624	25,90	31,30	24,58	2,50	25,90	108-0001-16-A 624	16	
18	108-0003-18-A 624	29,10	33,70	26,98	2,50	27,50	108-0001-18-A 624	18	
20	108-0003-20-A 624	32,30	36,85	29,36	5,40	30,60	108-0001-20-A 624	20	
22	108-0003-22-A 624	35,40	39,95	31,75	5,40	33,50	108-0001-22-A 624	22	
24	108-0003-24-A 624	38,60	43,15	34,92	5,40	37,00	108-0001-24-A 624	24	

Square flange

With straight cable clamp



Nickel Plating Reference	G max.	J mini.	J1 max.	L max.	Olive Drab Cadmium Plating Reference
AFD 50-08-**-P/S-* 059	15,65	6,80	5,15	45,85	AFD 50-08-**-P/S-* A 5347
AFD 50-10-**-P/S-* 059	18,60	9,30	7,25	45,85	AFD 50-10-**-P/S-* A 5347
AFD 50-12-**-P/S-* 059	21,75	12,75	10,55	45,85	AFD 50-12-**-P/S-* A 5347
AFD 50-14-**-P/S-* 059	24,95	14,65	12,05	51,85	AFD 50-14-**-P/S-* A 5347
AFD 50-16-**-P/S-* 059	28,20	17,80	15,85	51,85	AFD 50-16-**-P/S-* A 5347
AFD 50-18-**-P/S-* 059	30,90	19,80	17,90	51,85	AFD 50-18-**-P/S-* A 5347
AFD 50-20-**-P/S-* 059	34,15	23,00	21,05	53,35	AFD 50-20-**-P/S-* A 5347
AFD 50-22-**-P/S-* 059	37,25	26,15	24,25	53,35	AFD 50-22-**-P/S-* A 5347
AFD 50-24-**-P/S-* 059	40,45	29,10	27,45	53,35	AFD 50-24-**-P/S-* A 5347

With 90° end bell cable clamp



Nickel Plating Reference	G max.	J mini.	J1 max.	L max.	T max.	Olive Drab Cadmium Plating Reference
AFD 50-08-**-P/S-* 081	15,65	6,80	5,15	49,30	20,70	AFD 50-08-**-P/S-* A 5543
AFD 50-10-**-P/S-* 081	18,60	9,30	7,25	51,65	22,00	AFD 50-10-**-P/S-* A 5543
AFD 50-12-**-P/S-* 081	21,75	12,75	10,55	54,10	23,80	AFD 50-12-**-P/S-* A 5543
AFD 50-14-**-P/S-* 081	24,95	14,65	12,05	57,35	25,30	AFD 50-14-**-P/S-* A 5543
AFD 50-16-**-P/S-* 081	28,20	17,80	15,85	60,75	26,80	AFD 50-16-**-P/S-* A 5543
AFD 50-18-**-P/S-* 081	30,90	19,80	17,90	64,20	28,30	AFD 50-18-**-P/S-* A 5543
AFD 50-20-**-P/S-* 081	34,15	23,00	21,05	69,05	29,90	AFD 50-20-**-P/S-* A 5543
AFD 50-22-**-P/S-* 081	37,25	26,15	24,25	72,15	31,60	AFD 50-22-**-P/S-* A 5543
AFD 50-24-**-P/S-* 081	40,45	29,10	27,45	75,25	33,20	AFD 50-24-**-P/S-* A 5543

With potting cup



Nickel Plating Reference	G max.	J mini.	L max.	Olive Drab Cadmium Plating Reference
AFD 50-08-**-P/S-* 083	15,65	4,60	44,70	AFD 50-08-**-P/S-* A 5629
AFD 50-10-**-P/S-* 083	18,60	6,60	44,70	AFD 50-10-**-P/S-* A 5629
AFD 50-12-**-P/S-* 083	21,75	10,00	44,70	AFD 50-12-**-P/S-* A 5629
AFD 50-14-**-P/S-* 083	24,95	11,50	50,20	AFD 50-14-**-P/S-* A 5629
AFD 50-16-**-P/S-* 083	28,20	15,30	50,20	AFD 50-16-**-P/S-* A 5629
AFD 50-18-**-P/S-* 083	30,90	17,30	50,20	AFD 50-18-**-P/S-* A 5629
AFD 50-20-**-P/S-* 083	34,15	20,50	51,70	AFD 50-20-**-P/S-* A 5629
AFD 50-22-**-P/S-* 083	37,25	23,70	51,70	AFD 50-22-**-P/S-* A 5629
AFD 50-24-**-P/S-* 083	40,45	26,80	51,70	AFD 50-24-**-P/S-* A 5629

Fitting for thermo-shrink sleeve



Nickel Plating Reference	G max.	J mini.	L max.	P max.	S max.	Olive Drab Cadmium Plating Reference
AFD 50-08-**-P/S-* A 315	15,65	6,50	46,55	13,55	7,80	AFD 50-08-**-P/S-* A 5563
AFD 50-10-**-P/S-* A 315	18,60	9,20	46,55	15,40	7,80	AFD 50-10-**-P/S-* A 5563
AFD 50-12-**-P/S-* A 315	21,75	12,65	46,55	19,70	7,80	AFD 50-12-**-P/S-* A 5563
AFD 50-14-**-P/S-* A 315	24,95	14,50	46,55	21,30	7,80	AFD 50-14-**-P/S-* A 5563
AFD 50-16-**-P/S-* A 315	28,20	17,70	46,55	24,50	7,80	AFD 50-16-**-P/S-* A 5563
AFD 50-18-**-P/S-* A 315	30,90	19,70	46,55	26,50	7,80	AFD 50-18-**-P/S-* A 5563
AFD 50-20-**-P/S-* A 315	34,15	22,90	50,35	30,95	10,08	AFD 50-20-**-P/S-* A 5563
AFD 50-22-**-P/S-* A 315	37,25	26,05	51,00	34,45	10,65	AFD 50-22-**-P/S-* A 5563
AFD 50-24-**-P/S-* A 315	40,45	29,00	51,00	36,65	10,65	AFD 50-24-**-P/S-* A 5563

With grounding adaptor



Nickel Plating Reference	G max.	J mini.	L max.	Olive Drab Cadmium Plating Reference
AFD 50-08-**-P/S-* A 564	18,00	6,80	65,90	AFD 50-08-**-P/S-* A 5534
AFD 50-10-**-P/S-* A 564	20,10	9,30	65,70	AFD 50-10-**-P/S-* A 5534
AFD 50-12-**-P/S-* A 564	24,40	12,75	65,60	AFD 50-12-**-P/S-* A 5534
AFD 50-14-**-P/S-* A 564	27,50	14,65	65,80	AFD 50-14-**-P/S-* A 5534
AFD 50-16-**-P/S-* A 564	30,85	17,80	65,60	AFD 50-16-**-P/S-* A 5534
AFD 50-18-**-P/S-* A 564	33,90	19,80	64,90	AFD 50-18-**-P/S-* A 5534
AFD 50-20-**-P/S-* A 564	37,10	23,00	67,25	AFD 50-20-**-P/S-* A 5534
AFD 50-22-**-P/S-* A 564	40,20	26,15	67,35	AFD 50-22-**-P/S-* A 5534
AFD 50-24-**-P/S-* A 564	43,40	29,10	68,00	AFD 50-24-**-P/S-* A 5534

Note : L dimension calculated for a braid of 1 m/m thickness

Single hole mounting



With backshell
Nickel plating without Mod.
Olive drab cadmium plating Mod. A 231



Without backshell
Nickel plating Mod. 1A
Olive drab cadmium plating Mod. A 5324



Nickel Plating Reference	A max.	B max. ± 0,15	D max.	E max.	F max.	G max.	G1 max.	L max.	L1 max.	M max.	P max.	Olive Drab Cadmium Plating Reference		
AFD 54-08-**-P/S-*	1 A 27,35	24,20	17,78	2,85	12,03	15,65	12,70	36,85	30,85	19,20	7,75	AFD 54-08-**-P/S-*	A 231	A 5324
AFD 54-10-**-P/S-*	1 A 30,55	27,35	17,78	2,85	15,01	18,60	15,85	36,85	30,85	22,37	10,29	AFD 54-10-**-P/S-*	A 231	A 5324
AFD 54-12-**-P/S-*	1 A 35,30	32,15	17,78	2,85	19,07	21,75	19,05	36,85	30,85	27,12	13,49	AFD 54-12-**-P/S-*	A 231	A 5324
AFD 54-14-**-P/S-*	1 A 38,50	35,30	17,78	2,85	22,24	24,95	22,20	36,85	30,85	30,30	16,89	AFD 54-14-**-P/S-*	A 231	A 5324
AFD 54-16-**-P/S-*	1 A 41,65	38,50	17,78	2,85	25,42	28,20	25,40	36,85	30,85	33,47	20,07	AFD 54-16-**-P/S-*	A 231	A 5324
AFD 54-18-**-P/S-*	1 A 44,80	41,65	17,78	2,85	28,60	30,90	26,95	36,85	30,85	36,67	22,07	AFD 54-18-**-P/S-*	A 231	A 5324
AFD 54-20-**-P/S-*	1 A 49,60	46,40	19,43	3,70	31,77	34,15	30,15	38,40	32,35	39,82	25,25	AFD 54-20-**-P/S-*	A 231	A 5324
AFD 54-22-**-P/S-*	1 A 52,75	49,60	19,43	3,70	34,94	37,25	33,30	38,40	32,35	43,02	28,42	AFD 54-22-**-P/S-*	A 231	A 5324
AFD 54-24-**-P/S-*	1 A 55,95	52,75	19,43	3,70	38,12	40,45	36,50	38,40	32,35	46,17	31,60	AFD 54-24-**-P/S-*	A 231	A 5324

Mounting styles



Overall (as per accessory)

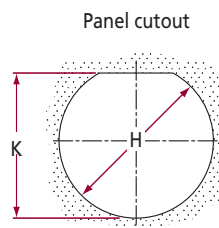

Panel cutout

Size	E max.	H +0 -0,2	K +0 -0,2	Tightening torque
08	4,30	14,65	13,85	7,5 mN
10	4,30	17,80	17,05	10 mN
12	4,30	22,55	21,15	13 mN
14	4,30	25,70	24,30	15 mN
16	4,30	28,90	27,45	18 mN
18	4,30	32,05	30,65	21 mN
20	6,35	35,25	33,80	23 mN
22	6,35	38,40	37,00	26 mN
24	6,35	41,60	40,15	29 mN

Panel nut

Size	Reference	Olive drab Cadmium	Nickel
08	006-0980-08	A 231	A 499
10	006-0980-10	A 231	A 499
12	006-0980-12	A 231	A 499
14	006-0980-14	A 231	A 499
16	006-0980-16	A 231	A 499
18	006-0980-18	A 231	A 499
20	006-0980-20	A 231	A 499
22	006-0980-22	A 231	A 499
24	006-0980-24	A 231	A 499

For single hole mounting receptacle

O'ring panel

Size	Reference
08	103-0001-16-02
10	103-0001-18-02
12	103-0001-21-02
14	103-0001-23-02
16	103-0001-25-02
18	103-0001-27-02
20	103-0001-29-02
22	103-0001-30-02
24	103-0001-31-02

Single hole mounting

With straight cable clamp

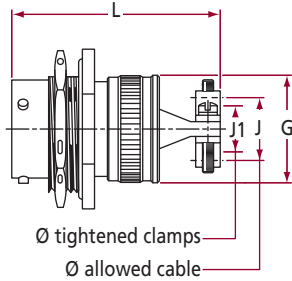

Nickel Plating Reference	G max.	J mini.	J1 max.	L max.	Olive Drab Cadmium Plating Reference
AFD 54-08-**-P/S-* 059	15,65	6,80	5,15	45,85	AFD 54-08-**-P/S-* A 5347
AFD 54-10-**-P/S-* 059	18,60	9,30	7,25	45,85	AFD 54-10-**-P/S-* A 5347
AFD 54-12-**-P/S-* 059	21,75	12,75	10,55	45,85	AFD 54-12-**-P/S-* A 5347
AFD 54-14-**-P/S-* 059	24,95	14,65	12,05	51,85	AFD 54-14-**-P/S-* A 5347
AFD 54-16-**-P/S-* 059	28,20	17,80	15,85	51,85	AFD 54-16-**-P/S-* A 5347
AFD 54-18-**-P/S-* 059	30,90	19,80	17,90	51,85	AFD 54-18-**-P/S-* A 5347
AFD 54-20-**-P/S-* 059	34,15	23,00	21,05	53,35	AFD 54-20-**-P/S-* A 5347
AFD 54-22-**-P/S-* 059	37,25	26,15	24,25	53,35	AFD 54-22-**-P/S-* A 5347
AFD 54-24-**-P/S-* 059	40,45	29,10	27,45	53,35	AFD 54-24-**-P/S-* A 5347

With 90° end bell cable clamp

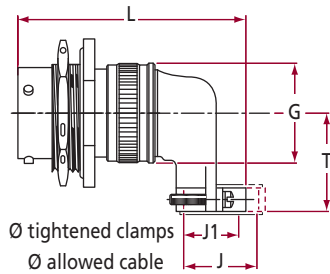

Nickel Plating Reference	G max.	J mini.	J1 max.	L max.	T max.	Olive Drab Cadmium Plating Reference
AFD 54-08-**-P/S-* 081	15,65	6,80	5,15	49,30	20,70	AFD 54-08-**-P/S-* A 5543
AFD 54-10-**-P/S-* 081	18,60	9,30	7,25	51,65	22,00	AFD 54-10-**-P/S-* A 5543
AFD 54-12-**-P/S-* 081	21,75	12,75	10,55	54,10	23,80	AFD 54-12-**-P/S-* A 5543
AFD 54-14-**-P/S-* 081	24,95	14,65	12,05	57,35	25,30	AFD 54-14-**-P/S-* A 5543
AFD 54-16-**-P/S-* 081	28,20	17,80	15,85	60,75	26,80	AFD 54-16-**-P/S-* A 5543
AFD 54-18-**-P/S-* 081	30,90	19,80	17,90	64,20	28,30	AFD 54-18-**-P/S-* A 5543
AFD 54-20-**-P/S-* 081	34,15	23,00	21,05	69,05	29,90	AFD 54-20-**-P/S-* A 5543
AFD 54-22-**-P/S-* 081	37,25	26,15	24,25	72,15	31,60	AFD 54-22-**-P/S-* A 5543
AFD 54-24-**-P/S-* 081	40,45	29,10	27,45	75,25	33,20	AFD 54-24-**-P/S-* A 5543

With potting cup

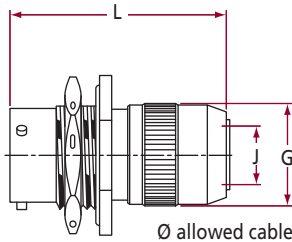

Nickel Plating Reference	G max.	J mini.	L max.	Olive Drab Cadmium Plating Reference
AFD 54-08-**-P/S-* 083	15,65	4,60	44,70	AFD 54-08-**-P/S-* A 5629
AFD 54-10-**-P/S-* 083	18,60	6,60	44,70	AFD 54-10-**-P/S-* A 5629
AFD 54-12-**-P/S-* 083	21,75	10,00	44,70	AFD 54-12-**-P/S-* A 5629
AFD 54-14-**-P/S-* 083	24,95	11,50	50,20	AFD 54-14-**-P/S-* A 5629
AFD 54-16-**-P/S-* 083	28,20	15,30	50,20	AFD 54-16-**-P/S-* A 5629
AFD 54-18-**-P/S-* 083	30,90	17,30	50,20	AFD 54-18-**-P/S-* A 5629
AFD 54-20-**-P/S-* 083	34,15	20,50	51,70	AFD 54-20-**-P/S-* A 5629
AFD 54-22-**-P/S-* 083	37,25	23,70	51,70	AFD 54-22-**-P/S-* A 5629
AFD 54-24-**-P/S-* 083	40,45	26,80	51,70	AFD 54-24-**-P/S-* A 5629

Fitting for thermo-shrink sleeve

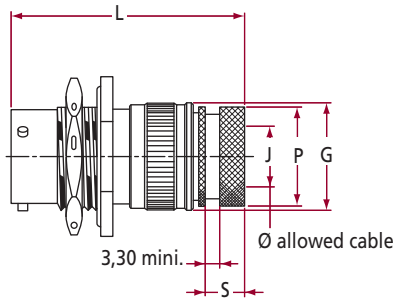

Nickel Plating Reference	G max.	J max.	L max.	P max.	S max.	Olive Drab Cadmium Plating Reference
AFD 54-08-**-P/S-* A 315	15,65	6,50	46,55	13,55	7,80	AFD 54-08-**-P/S-* A 5563
AFD 54-10-**-P/S-* A 315	18,60	9,20	46,55	15,40	7,80	AFD 54-10-**-P/S-* A 5563
AFD 54-12-**-P/S-* A 315	21,75	12,65	46,55	19,70	7,80	AFD 54-12-**-P/S-* A 5563
AFD 54-14-**-P/S-* A 315	24,95	14,50	46,55	21,30	7,80	AFD 54-14-**-P/S-* A 5563
AFD 54-16-**-P/S-* A 315	28,20	17,70	46,55	24,50	7,80	AFD 54-16-**-P/S-* A 5563
AFD 54-18-**-P/S-* A 315	30,90	19,70	46,55	26,50	7,80	AFD 54-18-**-P/S-* A 5563
AFD 54-20-**-P/S-* A 315	34,15	22,90	50,35	30,95	10,08	AFD 54-20-**-P/S-* A 5563
AFD 54-22-**-P/S-* A 315	37,25	26,05	51,00	34,45	10,65	AFD 54-22-**-P/S-* A 5563
AFD 54-24-**-P/S-* A 315	40,45	29,00	51,00	36,65	10,65	AFD 54-24-**-P/S-* A 5563

With grounding adaptor

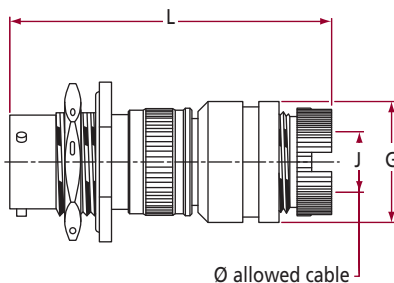

Nickel Plating Reference	G max.	J mini.	L max.	Olive Drab Cadmium Plating Reference
AFD 54-08-**-P/S-* A 564	18,00	6,80	65,90	AFD 54-08-**-P/S-* A 5534
AFD 54-10-**-P/S-* A 564	20,10	9,30	65,70	AFD 54-10-**-P/S-* A 5534
AFD 54-12-**-P/S-* A 564	24,40	12,75	65,60	AFD 54-12-**-P/S-* A 5534
AFD 54-14-**-P/S-* A 564	27,50	14,65	65,80	AFD 54-14-**-P/S-* A 5534
AFD 54-16-**-P/S-* A 564	30,85	17,80	65,60	AFD 54-16-**-P/S-* A 5534
AFD 54-18-**-P/S-* A 564	33,90	19,80	64,90	AFD 54-18-**-P/S-* A 5534
AFD 54-20-**-P/S-* A 564	37,10	23,00	67,25	AFD 54-20-**-P/S-* A 5534
AFD 54-22-**-P/S-* A 564	40,20	26,15	67,35	AFD 54-22-**-P/S-* A 5534
AFD 54-24-**-P/S-* A 564	43,40	29,10	68,00	AFD 54-24-**-P/S-* A 5534

Note : L dimension calculated for a braid of 1 m/m thickness

Plugs



Without backshell
 Nickel plating Mod. 1A
 Olive drab cadmium plating Mod. A 5324



With backshell
 Nickel plating without Mod.
 Olive drab cadmium plating Mod. A 231

Nickel Plating Reference	F max.	G max.	G1 max.	P max.	Olive Drab Cadmium Plating Reference
AFD 56-08-**-P/S-*	1 A 19,75	15,65	12,70	7,75	AFD 56-08-**-P/S-* A 231 A 5324
AFD 56-10-**-P/S-*	1 A 22,70	18,60	15,85	10,29	AFD 56-10-**-P/S-* A 231 A 5324
AFD 56-12-**-P/S-*	1 A 26,45	21,75	19,05	13,49	AFD 56-12-**-P/S-* A 231 A 5324
AFD 56-14-**-P/S-*	1 A 29,95	24,95	22,20	16,89	AFD 56-14-**-P/S-* A 231 A 5324
AFD 56-16-**-P/S-*	1 A 32,95	28,20	25,40	20,07	AFD 56-16-**-P/S-* A 231 A 5324
AFD 56-18-**-P/S-*	1 A 35,30	30,90	26,95	22,07	AFD 56-18-**-P/S-* A 231 A 5324
AFD 56-20-**-P/S-*	1 A 38,85	34,15	30,15	25,25	AFD 56-20-**-P/S-* A 231 A 5324
AFD 56-22-**-P/S-*	1 A 42,05	37,25	33,30	28,42	AFD 56-22-**-P/S-* A 231 A 5324
AFD 56-24-**-P/S-*	1 A 45,05	40,45	36,50	31,60	AFD 56-24-**-P/S-* A 231 A 5324

• With straight cable clamp



Nickel Plating Reference	G max.	J mini.	J1 max.	L max.	Olive Drab Cadmium Plating Reference
AFD 56-08-**-P/S-* 059	15,65	6,80	5,15	46,10	AFD 56-08-**-P/S-* A 5347
AFD 56-10-**-P/S-* 059	18,60	9,30	7,25	46,10	AFD 56-10-**-P/S-* A 5347
AFD 56-12-**-P/S-* 059	21,75	12,75	10,55	46,10	AFD 56-12-**-P/S-* A 5347
AFD 56-14-**-P/S-* 059	24,95	14,65	12,05	52,10	AFD 56-14-**-P/S-* A 5347
AFD 56-16-**-P/S-* 059	28,20	17,80	15,85	52,10	AFD 56-16-**-P/S-* A 5347
AFD 56-18-**-P/S-* 059	30,90	19,80	17,90	52,10	AFD 56-18-**-P/S-* A 5347
AFD 56-20-**-P/S-* 059	34,15	23,00	21,05	52,10	AFD 56-20-**-P/S-* A 5347
AFD 56-22-**-P/S-* 059	37,25	26,15	24,25	52,10	AFD 56-22-**-P/S-* A 5347
AFD 56-24-**-P/S-* 059	40,45	29,10	27,45	52,10	AFD 56-24-**-P/S-* A 5347

• With 90° end bell cable clamp

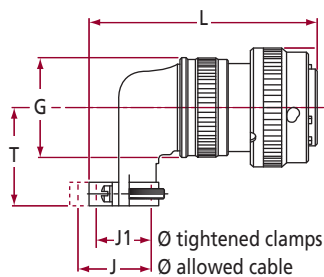

Nickel Plating Reference	G max.	J mini.	J1 max.	L max.	T max.	Olive Drab Cadmium Plating Reference
AFD 56-08-**-P/S-* 081	15,65	6,80	5,15	49,55	20,70	AFD 56-08-**-P/S-* A 5543
AFD 56-10-**-P/S-* 081	18,60	9,30	7,25	51,90	22,00	AFD 56-10-**-P/S-* A 5543
AFD 56-12-**-P/S-* 081	21,75	12,75	10,55	55,35	23,80	AFD 56-12-**-P/S-* A 5543
AFD 56-14-**-P/S-* 081	24,95	14,65	12,05	57,60	25,30	AFD 56-14-**-P/S-* A 5543
AFD 56-16-**-P/S-* 081	28,20	17,80	15,85	61,00	26,80	AFD 56-16-**-P/S-* A 5543
AFD 56-18-**-P/S-* 081	30,90	19,80	17,90	64,45	28,30	AFD 56-18-**-P/S-* A 5543
AFD 56-20-**-P/S-* 081	34,15	23,00	21,05	67,80	29,90	AFD 56-20-**-P/S-* A 5543
AFD 56-22-**-P/S-* 081	37,25	26,15	24,25	70,90	31,60	AFD 56-22-**-P/S-* A 5543
AFD 56-24-**-P/S-* 081	40,45	29,10	27,45	74,00	33,20	AFD 56-24-**-P/S-* A 5543

• With potting cup



Nickel Plating Reference	G max.	J mini.	L max.	Olive Drab Cadmium Plating Reference
AFD 56-08-**-P/S-* 083	15,65	4,60	45,45	AFD 56-08-**-P/S-* A 5629
AFD 56-10-**-P/S-* 083	18,60	6,60	45,45	AFD 56-10-**-P/S-* A 5629
AFD 56-12-**-P/S-* 083	21,75	10,00	45,45	AFD 56-12-**-P/S-* A 5629
AFD 56-14-**-P/S-* 083	24,95	11,50	50,95	AFD 56-14-**-P/S-* A 5629
AFD 56-16-**-P/S-* 083	28,20	15,30	50,95	AFD 56-16-**-P/S-* A 5629
AFD 56-18-**-P/S-* 083	30,90	17,30	50,95	AFD 56-18-**-P/S-* A 5629
AFD 56-20-**-P/S-* 083	34,15	20,50	50,95	AFD 56-20-**-P/S-* A 5629
AFD 56-22-**-P/S-* 083	37,25	23,70	50,95	AFD 56-22-**-P/S-* A 5629
AFD 56-24-**-P/S-* 083	40,45	26,80	50,95	AFD 56-24-**-P/S-* A 5629

• Fitting for thermo-shrink sleeve



Nickel Plating Reference	G max.	J max.	L max.	P max.	S max.	Olive Drab Cadmium Plating Reference
AFD 56-08-**-P/S-* A 315	15,65	6,50	46,80	13,55	7,80	AFD 56-08-**-P/S-* A 5563
AFD 56-10-**-P/S-* A 315	18,60	9,20	46,80	15,40	7,80	AFD 56-10-**-P/S-* A 5563
AFD 56-12-**-P/S-* A 315	21,75	12,65	46,80	19,70	7,80	AFD 56-12-**-P/S-* A 5563
AFD 56-14-**-P/S-* A 315	24,95	14,50	46,80	21,30	7,80	AFD 56-14-**-P/S-* A 5563
AFD 56-16-**-P/S-* A 315	28,20	17,70	46,80	24,50	7,80	AFD 56-16-**-P/S-* A 5563
AFD 56-18-**-P/S-* A 315	30,90	19,70	46,80	26,50	7,80	AFD 56-18-**-P/S-* A 5563
AFD 56-20-**-P/S-* A 315	34,15	22,90	49,10	30,95	10,08	AFD 56-20-**-P/S-* A 5563
AFD 56-22-**-P/S-* A 315	37,25	26,05	49,75	34,45	10,65	AFD 56-22-**-P/S-* A 5563
AFD 56-24-**-P/S-* A 315	40,45	29,00	49,75	36,65	10,65	AFD 56-24-**-P/S-* A 5563

• With grounding adaptor



Nickel Plating Reference	G max.	J mini.	L max.	Olive Drab Cadmium Plating Reference
AFD 56-08-**-P/S-* A 564	18,00	6,80	66,20	AFD 56-08-**-P/S-* A 5534
AFD 56-10-**-P/S-* A 564	20,10	9,30	66,00	AFD 56-10-**-P/S-* A 5534
AFD 56-12-**-P/S-* A 564	24,40	12,75	65,90	AFD 56-12-**-P/S-* A 5534
AFD 56-14-**-P/S-* A 564	27,50	14,65	66,10	AFD 56-14-**-P/S-* A 5534
AFD 56-16-**-P/S-* A 564	30,85	17,80	65,90	AFD 56-16-**-P/S-* A 5534
AFD 56-18-**-P/S-* A 564	33,90	19,80	65,20	AFD 56-18-**-P/S-* A 5534
AFD 56-20-**-P/S-* A 564	37,10	23,00	66,00	AFD 56-20-**-P/S-* A 5534
AFD 56-22-**-P/S-* A 564	40,20	26,15	66,10	AFD 56-22-**-P/S-* A 5534
AFD 56-24-**-P/S-* A 564	43,40	29,10	66,75	AFD 56-24-**-P/S-* A 5534

Note : L dimension calculated for a braid of 1 m/m thickness

• With RFI fingers

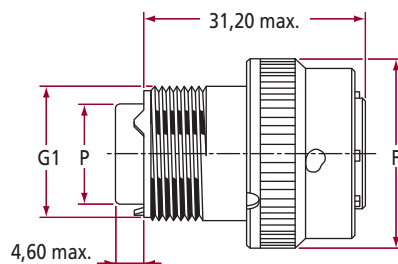

Without backshell
 Nickel plating Mod. 1A
 Olive drab cadmium plating Mod. A 5324



With backshell
 Nickel plating without Mod.
 Olive drab cadmium plating Mod. A 231

Nickel Plating Reference	1 A	F max.	G max.	G1 max.	P max.	Olive Drab Cadmium Plating Reference	A 231	A 5324
AFD 57-08-**-P/S-*	1 A	19,75	15,65	12,70	7,75	AFD 57-08-**-P/S-*	A 231	A 5324
AFD 57-10-**-P/S-*	1 A	22,70	18,60	15,85	10,29	AFD 57-10-**-P/S-*	A 231	A 5324
AFD 57-12-**-P/S-*	1 A	26,45	21,75	19,05	13,49	AFD 57-12-**-P/S-*	A 231	A 5324
AFD 57-14-**-P/S-*	1 A	29,95	24,95	22,20	16,89	AFD 57-14-**-P/S-*	A 231	A 5324
AFD 57-16-**-P/S-*	1 A	32,95	28,20	25,40	20,07	AFD 57-16-**-P/S-*	A 231	A 5324
AFD 57-18-**-P/S-*	1 A	35,30	30,90	26,95	22,07	AFD 57-18-**-P/S-*	A 231	A 5324
AFD 57-20-**-P/S-*	1 A	38,85	34,15	30,15	25,25	AFD 57-20-**-P/S-*	A 231	A 5324
AFD 57-22-**-P/S-*	1 A	42,05	37,25	33,30	28,42	AFD 57-22-**-P/S-*	A 231	A 5324
AFD 57-24-**-P/S-*	1 A	45,05	40,45	36,50	31,60	AFD 57-24-**-P/S-*	A 231	A 5324

• With straight cable clamp



Nickel Plating Reference	G max.	J mini.	J1 max.	L max.	Olive Drab Cadmium Plating Reference
AFD 57-08-**-P/S-* 059	15,65	6,80	5,15	46,10	AFD 57-08-**-P/S-* A 5347
AFD 57-10-**-P/S-* 059	18,60	9,30	7,25	46,10	AFD 57-10-**-P/S-* A 5347
AFD 57-12-**-P/S-* 059	21,75	12,75	10,55	46,10	AFD 57-12-**-P/S-* A 5347
AFD 57-14-**-P/S-* 059	24,95	14,65	12,05	52,10	AFD 57-14-**-P/S-* A 5347
AFD 57-16-**-P/S-* 059	28,20	17,80	15,85	52,10	AFD 57-16-**-P/S-* A 5347
AFD 57-18-**-P/S-* 059	30,90	19,80	17,90	52,10	AFD 57-18-**-P/S-* A 5347
AFD 57-20-**-P/S-* 059	34,15	23,00	21,05	52,10	AFD 57-20-**-P/S-* A 5347
AFD 57-22-**-P/S-* 059	37,25	26,15	24,25	52,10	AFD 57-22-**-P/S-* A 5347
AFD 57-24-**-P/S-* 059	40,45	29,10	27,45	52,10	AFD 57-24-**-P/S-* A 5347

• With 90° end bell cable clamp



Nickel Plating Reference	G max.	J mini.	J1 max.	L max.	T max.	Olive Drab Cadmium Plating Reference
AFD 57-08-**-P/S-* 081	15,65	6,80	5,15	49,55	20,70	AFD 57-08-**-P/S-* A 5543
AFD 57-10-**-P/S-* 081	18,60	9,30	7,25	51,90	22,00	AFD 57-10-**-P/S-* A 5543
AFD 57-12-**-P/S-* 081	21,75	12,75	10,55	55,35	23,80	AFD 57-12-**-P/S-* A 5543
AFD 57-14-**-P/S-* 081	24,95	14,65	12,05	57,60	25,30	AFD 57-14-**-P/S-* A 5543
AFD 57-16-**-P/S-* 081	28,20	17,80	15,85	61,00	26,80	AFD 57-16-**-P/S-* A 5543
AFD 57-18-**-P/S-* 081	30,90	19,80	17,90	64,45	28,30	AFD 57-18-**-P/S-* A 5543
AFD 57-20-**-P/S-* 081	34,15	23,00	21,05	67,80	29,90	AFD 57-20-**-P/S-* A 5543
AFD 57-22-**-P/S-* 081	37,25	26,15	24,25	70,90	31,60	AFD 57-22-**-P/S-* A 5543
AFD 57-24-**-P/S-* 081	40,45	29,10	27,45	74,00	33,20	AFD 57-24-**-P/S-* A 5543

• With potting cup



Nickel Plating Reference	G max.	J mini.	L max.	Olive Drab Cadmium Plating Reference
AFD 57-08-**-P/S-* 083	15,65	4,60	45,45	AFD 57-08-**-P/S-* A 5629
AFD 57-10-**-P/S-* 083	18,60	6,60	45,45	AFD 57-10-**-P/S-* A 5629
AFD 57-12-**-P/S-* 083	21,75	10,00	45,45	AFD 57-12-**-P/S-* A 5629
AFD 57-14-**-P/S-* 083	24,95	11,50	50,95	AFD 57-14-**-P/S-* A 5629
AFD 57-16-**-P/S-* 083	28,20	15,30	50,95	AFD 57-16-**-P/S-* A 5629
AFD 57-18-**-P/S-* 083	30,90	17,30	50,95	AFD 57-18-**-P/S-* A 5629
AFD 57-20-**-P/S-* 083	34,15	20,50	50,95	AFD 57-20-**-P/S-* A 5629
AFD 57-22-**-P/S-* 083	37,25	23,70	50,95	AFD 57-22-**-P/S-* A 5629
AFD 57-24-**-P/S-* 083	40,45	26,80	50,95	AFD 57-24-**-P/S-* A 5629

• Fitting for thermo-shrink sleeve

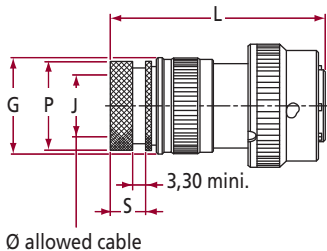

Nickel Plating Reference	G max.	J max.	L max.	P max.	S max.	Olive Drab Cadmium Plating Reference
AFD 57-08-**-P/S-* A 315	15,65	6,50	46,80	13,55	7,80	AFD 57-08-**-P/S-* A 5563
AFD 57-10-**-P/S-* A 315	18,60	9,20	46,80	15,40	7,80	AFD 57-10-**-P/S-* A 5563
AFD 57-12-**-P/S-* A 315	21,75	12,65	46,80	19,70	7,80	AFD 57-12-**-P/S-* A 5563
AFD 57-14-**-P/S-* A 315	24,95	14,50	46,80	21,30	7,80	AFD 57-14-**-P/S-* A 5563
AFD 57-16-**-P/S-* A 315	28,20	17,70	46,80	24,50	7,80	AFD 57-16-**-P/S-* A 5563
AFD 57-18-**-P/S-* A 315	30,90	19,70	46,80	26,50	7,80	AFD 57-18-**-P/S-* A 5563
AFD 57-20-**-P/S-* A 315	34,15	22,90	49,10	30,95	10,08	AFD 57-20-**-P/S-* A 5563
AFD 57-22-**-P/S-* A 315	37,25	26,05	49,75	34,45	10,65	AFD 57-22-**-P/S-* A 5563
AFD 57-24-**-P/S-* A 315	40,45	29,00	49,75	36,65	10,65	AFD 57-24-**-P/S-* A 5563

• With grounding adaptor



Nickel Plating Reference	G max.	J mini.	L max.	Olive Drab Cadmium Plating Reference
AFD 57-08-**-P/S-* A 564	18,00	6,80	66,20	AFD 57-08-**-P/S-* A 5534
AFD 57-10-**-P/S-* A 564	20,10	9,30	66,00	AFD 57-10-**-P/S-* A 5534
AFD 57-12-**-P/S-* A 564	24,40	12,75	65,90	AFD 57-12-**-P/S-* A 5534
AFD 57-14-**-P/S-* A 564	27,50	14,65	66,10	AFD 57-14-**-P/S-* A 5534
AFD 57-16-**-P/S-* A 564	30,85	17,80	65,90	AFD 57-16-**-P/S-* A 5534
AFD 57-18-**-P/S-* A 564	33,90	19,80	65,20	AFD 57-18-**-P/S-* A 5534
AFD 57-20-**-P/S-* A 564	37,10	23,00	66,00	AFD 57-20-**-P/S-* A 5534
AFD 57-22-**-P/S-* A 564	40,20	26,15	66,10	AFD 57-22-**-P/S-* A 5534
AFD 57-24-**-P/S-* A 564	43,40	29,10	66,75	AFD 57-24-**-P/S-* A 5534

Note : L dimension calculated for a braid of 1 m/m thickness

Large square flange receptacle



With backshell

Nickel plating without Mod.
Olive drab cadmium plating Mod. A 231

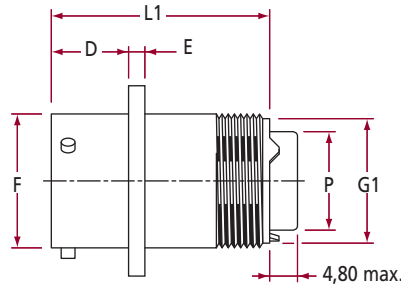

Without backshell

Nickel plating Mod. 1A
Olive drab cadmium plating Mod. A 5324

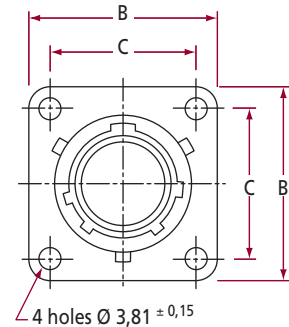

Nickel Plating Reference	B max.	C ± 0,1	D ± 0,15	E max.	F max.	G max.	G1 max.	L max.	L1 max.	P max.	Olive Drab Cadmium Plating Reference
AFD 58-08-**-P/S-*	1 A 27,05	18,64	11,89	1,95	12,03	15,65	12,70	36,85	30,85	7,75	AFD 58-08-**-P/S-*
AFD 58-10-**-P/S-*	1 A 28,95	20,62	11,89	1,95	15,01	18,60	15,85	36,85	30,85	10,29	AFD 58-10-**-P/S-*
AFD 58-12-**-P/S-*	1 A 32,15	23,82	11,89	1,95	19,07	21,75	19,05	36,85	30,85	13,49	AFD 58-12-**-P/S-*
AFD 58-14-**-P/S-*	1 A 34,50	26,22	11,89	1,95	22,24	24,95	22,20	36,85	30,85	16,89	AFD 58-14-**-P/S-*
AFD 58-16-**-P/S-*	1 A 36,90	28,56	11,89	1,95	25,42	28,20	25,40	36,85	30,85	20,07	AFD 58-16-**-P/S-*
AFD 58-18-**-P/S-*	1 A 38,90	30,58	11,89	1,95	28,60	30,90	26,95	36,85	30,85	22,07	AFD 58-18-**-P/S-*
AFD 58-20-**-P/S-*	1 A 42,85	32,96	14,30	2,55	31,77	34,15	30,15	38,40	32,35	25,25	AFD 58-20-**-P/S-*
AFD 58-22-**-P/S-*	1 A 44,85	34,96	14,30	2,55	34,94	37,25	33,30	38,40	32,35	28,42	AFD 58-22-**-P/S-*
AFD 58-24-**-P/S-*	1 A 48,00	38,10	15,37	2,55	38,12	40,45	36,50	38,40	32,35	31,60	AFD 58-24-**-P/S-*

Mounting styles

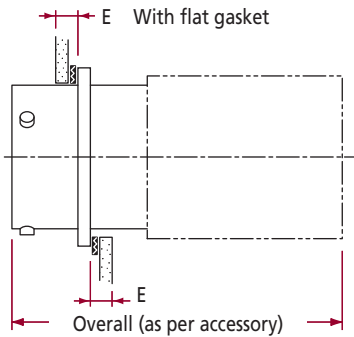

Overall (as per accessory)

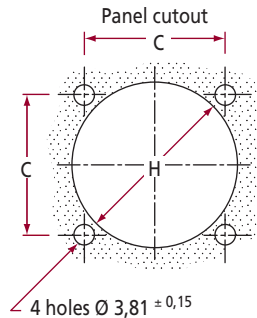

Size	C ± 0,1	H +0 -0,2	E max.
08	18,64	16,05	2,50
10	20,62	19,00	2,50
12	23,82	22,25	2,50
14	26,22	25,40	2,50
16	28,56	28,60	2,50
18	30,58	31,75	2,50
20	32,96	34,90	5,40
22	34,96	38,10	5,40
24	38,10	41,30	5,40

Flat gasket for square flange receptacle

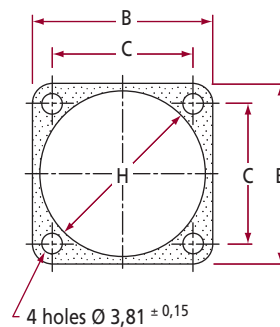
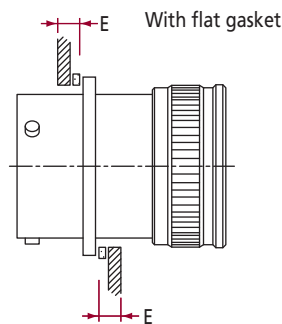

Front Flange Mounting					Rear Flange Mounting			
Size	Reference	H max.	B max.	C ± 0,1	E max.	H max.	Reference	Size
08	108-0003-08-A 624	12,50	21,00	15,08	2,50	13,20	108-0001-08-A 624	08
10	108-0003-10-A 624	15,40	24,20	18,26	2,50	16,40	108-0001-10-A 624	10
12	108-0001-12-A 624	19,50	26,55	20,62	2,50	19,50	108-0001-12-A 624	12
14	108-0001-14-A 624	22,70	28,95	23,02	2,50	22,70	108-0001-14-A 624	14
16	108-0001-16-A 624	25,90	31,30	24,58	2,50	25,90	108-0001-16-A 624	16
18	108-0003-18-A 624	29,10	33,70	26,98	2,50	27,50	108-0001-18-A 624	18
20	108-0003-20-A 624	32,30	36,85	29,36	5,40	30,60	108-0001-20-A 624	20
22	108-0003-22-A 624	35,40	39,95	31,75	5,40	33,50	108-0001-22-A 624	22
24	108-0003-24-A 624	38,60	43,15	34,92	5,40	37,00	108-0001-24-A 624	24

A 624 = Flat gasket resistant to oronite

Large square flange

With straight cable clamp



Nickel Plating Reference	G max.	J mini.	J1 max.	L max.	Olive Drab Cadmium Plating Reference
AFD 58-08-**-P/S-* 059	15,65	6,80	5,15	45,85	AFD 58-08-**-P/S-* A 5347
AFD 58-10-**-P/S-* 059	18,60	9,30	7,25	45,85	AFD 58-10-**-P/S-* A 5347
AFD 58-12-**-P/S-* 059	21,75	12,75	10,55	45,85	AFD 58-12-**-P/S-* A 5347
AFD 58-14-**-P/S-* 059	24,95	14,65	12,05	51,85	AFD 58-14-**-P/S-* A 5347
AFD 58-16-**-P/S-* 059	28,20	17,80	15,85	51,85	AFD 58-16-**-P/S-* A 5347
AFD 58-18-**-P/S-* 059	30,90	19,80	17,90	51,85	AFD 58-18-**-P/S-* A 5347
AFD 58-20-**-P/S-* 059	34,15	23,00	21,05	53,35	AFD 58-20-**-P/S-* A 5347
AFD 58-22-**-P/S-* 059	37,25	26,15	24,25	53,35	AFD 58-22-**-P/S-* A 5347
AFD 58-24-**-P/S-* 059	40,45	29,10	27,45	53,35	AFD 58-24-**-P/S-* A 5347

With 90° end bell cable clamp

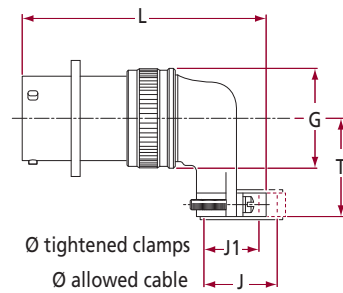

Nickel Plating Reference	G max.	J mini.	J1 max.	L max.	T max.	Olive Drab Cadmium Plating Reference
AFD 58-08-**-P/S-* 081	15,65	6,80	5,15	49,30	20,70	AFD 58-08-**-P/S-* A 5543
AFD 58-10-**-P/S-* 081	18,60	9,30	7,25	51,65	22,00	AFD 58-10-**-P/S-* A 5543
AFD 58-12-**-P/S-* 081	21,75	12,75	10,55	54,10	23,80	AFD 58-12-**-P/S-* A 5543
AFD 58-14-**-P/S-* 081	24,95	14,65	12,05	57,35	25,30	AFD 58-14-**-P/S-* A 5543
AFD 58-16-**-P/S-* 081	28,20	17,80	15,85	60,75	26,80	AFD 58-16-**-P/S-* A 5543
AFD 58-18-**-P/S-* 081	30,90	19,80	17,90	64,20	28,30	AFD 58-18-**-P/S-* A 5543
AFD 58-20-**-P/S-* 081	34,15	23,00	21,05	69,05	29,90	AFD 58-20-**-P/S-* A 5543
AFD 58-22-**-P/S-* 081	37,25	26,15	24,25	72,15	31,60	AFD 58-22-**-P/S-* A 5543
AFD 58-24-**-P/S-* 081	40,45	29,10	27,45	75,25	33,20	AFD 58-24-**-P/S-* A 5543

With potting cup

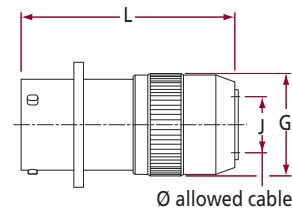

Nickel Plating Reference	G max.	J mini.	L max.	Olive Drab Cadmium Plating Reference
AFD 58-08-**-P/S-* 083	15,65	4,60	44,70	AFD 58-08-**-P/S-* A 5629
AFD 58-10-**-P/S-* 083	18,60	6,60	44,70	AFD 58-10-**-P/S-* A 5629
AFD 58-12-**-P/S-* 083	21,75	10,00	44,70	AFD 58-12-**-P/S-* A 5629
AFD 58-14-**-P/S-* 083	24,95	11,50	50,20	AFD 58-14-**-P/S-* A 5629
AFD 58-16-**-P/S-* 083	28,20	15,30	50,20	AFD 58-16-**-P/S-* A 5629
AFD 58-18-**-P/S-* 083	30,90	17,30	50,20	AFD 58-18-**-P/S-* A 5629
AFD 58-20-**-P/S-* 083	34,15	20,50	51,70	AFD 58-20-**-P/S-* A 5629
AFD 58-22-**-P/S-* 083	37,25	23,70	51,70	AFD 58-22-**-P/S-* A 5629
AFD 58-24-**-P/S-* 083	40,45	26,80	51,70	AFD 58-24-**-P/S-* A 5629

Fitting for thermo-shrink sleeve

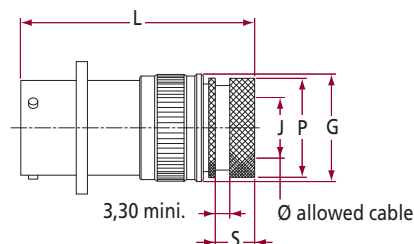

Nickel Plating Reference	G max.	J mini.	L max.	P max.	S max.	Olive Drab Cadmium Plating Reference
AFD 58-08-**-P/S-* A 315	15,65	6,50	46,55	13,55	7,80	AFD 58-08-**-P/S-* A 5563
AFD 58-10-**-P/S-* A 315	18,60	9,20	46,55	15,40	7,80	AFD 58-10-**-P/S-* A 5563
AFD 58-12-**-P/S-* A 315	21,75	12,65	46,55	19,70	7,80	AFD 58-12-**-P/S-* A 5563
AFD 58-14-**-P/S-* A 315	24,95	14,50	46,55	21,30	7,80	AFD 58-14-**-P/S-* A 5563
AFD 58-16-**-P/S-* A 315	28,20	17,70	46,55	24,50	7,80	AFD 58-16-**-P/S-* A 5563
AFD 58-18-**-P/S-* A 315	30,90	19,70	46,55	26,50	7,80	AFD 58-18-**-P/S-* A 5563
AFD 58-20-**-P/S-* A 315	34,15	22,90	50,35	30,95	10,08	AFD 58-20-**-P/S-* A 5563
AFD 58-22-**-P/S-* A 315	37,25	26,05	51,00	34,45	10,65	AFD 58-22-**-P/S-* A 5563
AFD 58-24-**-P/S-* A 315	40,45	29,00	51,00	36,65	10,65	AFD 58-24-**-P/S-* A 5563

With grounding adaptor

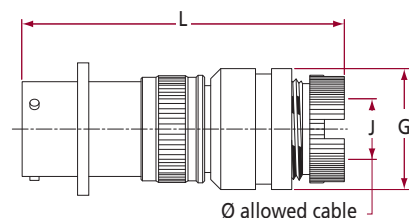

Nickel Plating Reference	G max.	J mini.	L max.	Olive Drab Cadmium Plating Reference
AFD 58-08-**-P/S-* A 564	18,00	6,80	65,90	AFD 58-08-**-P/S-* A 5534
AFD 58-10-**-P/S-* A 564	20,10	9,30	65,70	AFD 58-10-**-P/S-* A 5534
AFD 58-12-**-P/S-* A 564	24,40	12,75	65,60	AFD 58-12-**-P/S-* A 5534
AFD 58-14-**-P/S-* A 564	27,50	14,65	65,80	AFD 58-14-**-P/S-* A 5534
AFD 58-16-**-P/S-* A 564	30,85	17,80	65,60	AFD 58-16-**-P/S-* A 5534
AFD 58-18-**-P/S-* A 564	33,90	19,80	64,90	AFD 58-18-**-P/S-* A 5534
AFD 58-20-**-P/S-* A 564	37,10	23,00	67,25	AFD 58-20-**-P/S-* A 5534
AFD 58-22-**-P/S-* A 564	40,20	26,15	67,35	AFD 58-22-**-P/S-* A 5534
AFD 58-24-**-P/S-* A 564	43,40	29,10	68,00	AFD 58-24-**-P/S-* A 5534

Note : L dimension calculated for a braid of 1 m/m thickness

With backshell



Nickel Plating Reference	A max.	B max.	D ± 0,15	E max.	F max.	G max.	L max.	Olive Drab Cadmium Plating Reference
AFD 51-08-**-P/S-*	24,15	21,00	11,13	1,95	12,03	15,65	36,85	AFD 51-08-**-P/S-* A 231
AFD 51-10-**-P/S-*	27,30	24,20	11,13	1,95	15,01	18,60	36,85	AFD 51-10-**-P/S-* A 231
AFD 51-12-**-P/S-*	29,70	26,55	11,13	1,95	19,07	21,75	36,85	AFD 51-12-**-P/S-* A 231
AFD 51-14-**-P/S-*	32,05	28,95	11,13	1,95	22,24	24,95	36,85	AFD 51-14-**-P/S-* A 231
AFD 51-16-**-P/S-*	34,45	31,30	11,13	1,95	25,42	28,20	36,85	AFD 51-16-**-P/S-* A 231
AFD 51-18-**-P/S-*	36,85	33,70	11,13	1,95	28,60	30,90	36,85	AFD 51-18-**-P/S-* A 231
AFD 51-20-**-P/S-*	40,00	36,85	14,30	2,55	31,77	34,15	38,40	AFD 51-20-**-P/S-* A 231
AFD 51-22-**-P/S-*	43,20	39,95	14,30	2,55	34,94	37,25	38,40	AFD 51-22-**-P/S-* A 231
AFD 51-24-**-P/S-*	46,30	43,15	15,10	2,55	38,12	40,45	38,40	AFD 51-24-**-P/S-* A 231

With straight cable clamp



Nickel Plating Reference	A max.	B max.	D ± 0,15	E max.	F max.	G max.	J mini.	J1 max.	L max.	Olive Drab Cadmium Plating Reference
AFD 51-08-**-P/S*-059	24,15	21,00	11,13	1,95	12,03	15,65	6,80	5,15	45,85	AFD 51-08-**-P/S*-A 5347
AFD 51-10-**-P/S*-059	27,30	24,20	11,13	1,95	15,01	18,60	9,30	7,25	45,85	AFD 51-10-**-P/S*-A 5347
AFD 51-12-**-P/S*-059	29,70	26,55	11,13	1,95	19,07	21,75	12,75	10,55	45,85	AFD 51-12-**-P/S*-A 5347
AFD 51-14-**-P/S*-059	32,05	28,95	11,13	1,95	22,24	24,95	14,65	12,05	51,85	AFD 51-14-**-P/S*-A 5347
AFD 51-16-**-P/S*-059	34,45	31,30	11,13	1,95	25,42	28,20	17,80	15,85	51,85	AFD 51-16-**-P/S*-A 5347
AFD 51-18-**-P/S*-059	36,85	33,70	11,13	1,95	28,60	30,90	19,80	17,90	51,85	AFD 51-18-**-P/S*-A 5347
AFD 51-20-**-P/S*-059	40,00	36,85	14,30	2,55	31,77	34,15	23,00	21,05	53,35	AFD 51-20-**-P/S*-A 5347
AFD 51-22-**-P/S*-059	43,20	39,95	14,30	2,55	34,94	37,25	26,15	24,25	53,35	AFD 51-22-**-P/S*-A 5347
AFD 51-24-**-P/S*-059	46,30	43,15	15,10	2,55	38,12	40,45	29,10	27,45	53,35	AFD 51-24-**-P/S*-A 5347

AFD 56 / AFD 50



Size	E max.	K max.	L max.	L' max.	L1 max.	L1' max.
08 to 18	2,50	23,85	48,10	50,10	38,70	40,70
20 to 22	5,40	21,45	52,60	55,15	43,30	45,85
24	5,40	20,65	53,40	55,95	44,10	46,65

AFD 56 / AFD 54



Size	E max.	K max.	L max.	L1 max.
08 to 18	4,30	16,30	54,75	45,45
20 to 24	6,35	15,35	56,40	47,10

Backshell



Size	Nickel Plating Reference	Olive Drab Cadmium Reference
08	94002-08-3014	94002-08-A 231
10	94002-10-3014	94002-10-A 231
12	94002-12-3014	94002-12-A 231
14	94002-14-3014	94002-14-A 231
16	94002-16-3014	94002-16-A 231
18	94002-18-3014	94002-18-A 231
20	94002-20-3014	94002-20-A 231
22	94002-22-3014	94002-22-A 231
24	94002-24-3014	94002-24-A 231

Straight cable clamp



Size	Nickel Plating Reference	Olive Drab Cadmium Reference
08	94003-08-3014	94003-08-A 231
10	94003-10-3014	94003-10-A 231
12	94003-12-3014	94003-12-A 231
14	94003-14-3014	94003-14-A 231
16	94003-16-3014	94003-16-A 231
18	94003-18-3014	94003-18-A 231
20	94003-20-3014	94003-20-A 231
22	94003-22-3014	94003-22-A 231
24	94003-24-3014	94003-24-A 231

90° end bell cable clamp



Size	Nickel Plating Reference	Olive Drab Cadmium Reference
08	94004-08-3014	94004-08-A 231
10	94004-10-3014	94004-10-A 231
12	94004-12-3014	94004-12-A 231
14	94004-14-3014	94004-14-A 231
16	94004-16-3014	94004-16-A 231
18	94004-18-3014	94004-18-A 231
20	94004-20-3014	94004-20-A 231
22	94004-22-3014	94004-22-A 231
24	94004-24-3014	94004-24-A 231

Potting cup

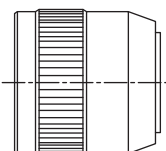

Size	Nickel Plating Reference	Olive Drab Cadmium Reference
08	006-0701-08-A 499	006-0701-08-A 231
10	006-0701-10-A 499	006-0701-10-A 231
12	006-0701-12-A 499	006-0701-12-A 231
14	006-0701-14-A 499	006-0701-14-A 231
16	006-0701-16-A 499	006-0701-16-A 231
18	006-0701-18-A 499	006-0701-18-A 231
20	006-0701-20-A 499	006-0701-20-A 231
22	006-0701-22-A 499	006-0701-22-A 231
24	006-0701-24-A 499	006-0701-24-A 231

Thermo-shrink sleeve



Size	Nickel Plating Reference	Olive Drab Cadmium Reference
08	004-0062-08-A 499	004-0062-08-A 231
10	004-0062-10-A 499	004-0062-10-A 231
12	004-0062-12-A 499	004-0062-12-A 231
14	004-0062-14-A 499	004-0062-14-A 231
16	004-0062-16-A 499	004-0062-16-A 231
18	004-0062-18-A 499	004-0062-18-A 231
20	004-0062-20-A 499	004-0062-20-A 231
22	004-0062-22-A 499	004-0062-22-A 231
24	004-0062-24-A 499	004-0062-24-A 231

Grounding adaptor



Size	Nickel Plating Reference	Olive Drab Cadmium Reference
08	014-1048-08-A 499	014-1048-08-A 231
10	014-1048-10-A 499	014-1048-10-A 231
12	014-1048-12-A 499	014-1048-12-A 231
14	014-1048-14-A 499	014-1048-14-A 231
16	014-1048-16-A 499	014-1048-16-A 231
18	014-1048-18-A 499	014-1048-18-A 231
20	014-1048-20-A 499	014-1048-20-A 231
22	014-1048-22-A 499	014-1048-22-A 231
24	014-1048-24-A 499	014-1048-24-A 231

Dummy receptacle for plugs

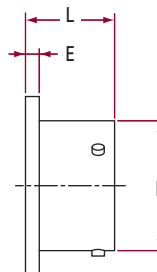

Nickel Plating Reference	B max.	C $\pm 0,1$	E max.	F max.	L max.	Olive Drab Cadmium Plating Reference
AFD 50-PR-08	21,00	15,08	1,95	12,03	14,70	AFD 50-PR-08-A 231
AFD 50-PR-10	24,20	18,26	1,95	15,01	14,70	AFD 50-PR-10-A 231
AFD 50-PR-12	26,55	20,62	1,95	19,07	14,70	AFD 50-PR-12-A 231
AFD 50-PR-14	28,95	23,02	1,95	22,24	14,70	AFD 50-PR-14-A 231
AFD 50-PR-16	31,30	24,58	1,95	25,42	14,70	AFD 50-PR-16-A 231
AFD 50-PR-18	33,70	26,98	1,95	28,60	14,70	AFD 50-PR-18-A 231
AFD 50-PR-20	36,85	29,36	2,55	31,77	17,20	AFD 50-PR-20-A 231
AFD 50-PR-22	39,95	31,76	2,55	34,94	17,20	AFD 50-PR-22-A 231
AFD 50-PR-24	43,15	34,92	2,55	38,12	17,20	AFD 50-PR-24-A 231

For receptacle mounting on square flange receptacle



Nickel Plating Reference		F max.	L max.	L1 ± 5	L2 max.	P max.	Olive Drab Cadmium Reference	
Nylon braid	Stainless chain						Nylon braid	Stainless chain
AFD B 50-08	AFD C 50-08	16,60	17,85	130,00	79,00	14,20	AFD B 50-08- A 231	AFD C 50-08-A 231
AFD B 50-10	AFD C 50-10	19,70	17,85	130,00	79,00	14,20	AFD B 50-10- A 231	AFD C 50-10-A 231
AFD B 50-12	AFD C 50-12	24,60	17,85	130,00	95,00	14,20	AFD B 50-12- A 231	AFD C 50-12-A 231
AFD B 50-14	AFD C 50-14	27,80	17,85	130,00	95,00	14,20	AFD B 50-14- A 231	AFD C 50-14-A 231
AFD B 50-16	AFD C 50-16	30,90	17,85	142,00	95,00	14,20	AFD B 50-16- A 231	AFD C 50-16-A 231
AFD B 50-18	AFD C 50-18	34,10	17,85	142,00	95,00	14,20	AFD B 50-18- A 231	AFD C 50-18-A 231
AFD B 50-20	AFD C 50-20	37,30	17,85	142,00	111,00	14,20	AFD B 50-20- A 231	AFD C 50-20-A 231
AFD B 50-22	AFD C 50-22	40,50	17,85	142,00	111,00	14,20	AFD B 50-22- A 231	AFD C 50-22-A 231
AFD B 50-24	AFD C 50-24	44,10	18,85	142,00	111,00	15,20	AFD B 50-24- A 231	AFD C 50-24-A 231

For receptacle mounting on single hole mounting



Nickel Plating Reference		F max.	G mini.	L max.	L1 ± 5	L2 max.	P max.	Olive Drab Cadmium Reference	
Nylon braid	Stainless chain							Nylon braid	Stainless chain
AFD B 50-54-08	AFD C 50-54-08	16,60	14,60	17,85	130,00	79,00	14,20	AFD B 50-54-08- A 231	AFD C 50-54-08-A 231
AFD B 50-54-10	AFD C 50-54-10	19,70	17,70	17,85	130,00	79,00	14,20	AFD B 50-54-10- A 231	AFD C 50-54-10-A 231
AFD B 50-54-12	AFD C 50-54-12	24,60	22,50	17,85	130,00	95,00	14,20	AFD B 50-54-12- A 231	AFD C 50-54-12-A 231
AFD B 50-54-14	AFD C 50-54-14	27,80	25,70	17,85	130,00	95,00	14,20	AFD B 50-54-14- A 231	AFD C 50-54-14-A 231
AFD B 50-54-16	AFD C 50-54-16	30,90	28,90	17,85	142,00	95,00	14,20	AFD B 50-54-16- A 231	AFD C 50-54-16-A 231
AFD B 50-54-18	AFD C 50-54-18	34,10	32,00	17,85	142,00	95,00	14,20	AFD B 50-54-18- A 231	AFD C 50-54-18-A 231
AFD B 50-54-20	AFD C 50-54-20	37,30	35,20	17,85	142,00	111,00	14,20	AFD B 50-54-20- A 231	AFD C 50-54-20-A 231
AFD B 50-54-22	AFD C 50-54-22	40,50	38,40	17,85	142,00	111,00	14,20	AFD B 50-54-22- A 231	AFD C 50-54-22-A 231
AFD B 50-54-24	AFD C 50-54-24	44,10	41,60	18,85	142,00	111,00	15,20	AFD B 50-54-24- A 231	AFD C 50-54-24-A 231

For plug attached to cable clamp



Nickel Plating Reference		A	B	F	L	L1	L2	P	Olive Drab Cadmium Reference	
Nylon braid	Stainless chain	max.	max.	max.	max.	± 5	max.	max.	Nylon braid	Stainless chain
AFD B 56-08	AFD C 56-08	18,30	16,10	12,03	18,65	130,00	95,00	14,40	AFD B 56-08-A 231	AFD C 56-08-A 231
AFD B 56-10	AFD C 56-10	21,50	18,10	15,01	18,65	130,00	95,00	14,40	AFD B 56-10-A 231	AFD C 56-10-A 231
AFD B 56-12	AFD C 56-12	25,40	22,10	19,07	18,65	130,00	111,00	14,40	AFD B 56-12-A 231	AFD C 56-12-A 231
AFD B 56-14	AFD C 56-14	28,60	24,10	22,24	18,65	130,00	111,00	14,40	AFD B 56-14-A 231	AFD C 56-14-A 231
AFD B 56-16	AFD C 56-16	31,80	27,10	25,42	18,65	142,00	111,00	14,40	AFD B 56-16-A 231	AFD C 56-16-A 231
AFD B 56-18	AFD C 56-18	34,90	30,10	28,60	18,65	142,00	111,00	14,40	AFD B 56-18-A 231	AFD C 56-18-A 231
AFD B 56-20	AFD C 56-20	38,10	33,10	31,77	20,25	142,00	127,00	16,00	AFD B 56-20-A 231	AFD C 56-20-A 231
AFD B 56-22	AFD C 56-22	41,30	36,10	34,94	20,25	142,00	127,00	16,00	AFD B 56-22-A 231	AFD C 56-22-A 231
AFD B 56-24	AFD C 56-24	44,50	41,10	38,12	21,10	142,00	127,00	16,80	AFD B 56-24-A 231	AFD C 56-24-A 231

For plug attached for plug

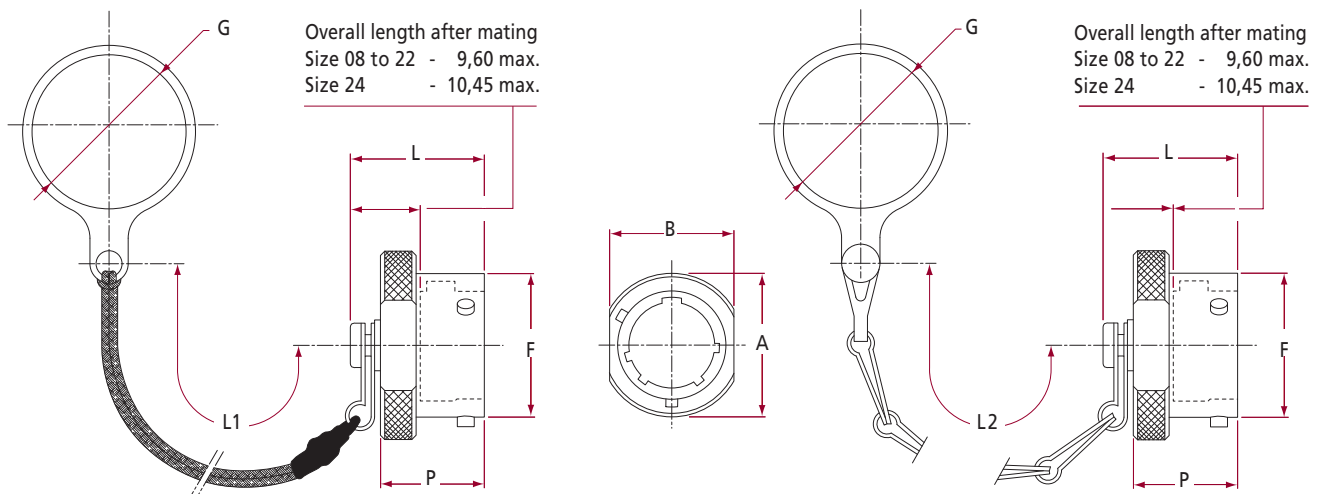

Nickel Plating Reference		A	B	F	G	L	L1	L2	P	Olive Drab Cadmium Reference	
Nylon braid	Stainless chain	max.	max.	max.	mini.	max.	± 5	max.	max.	Nylon braid	Stainless chain
AFD B 56-56-08	AFD C 56-56-08	18,30	16,10	12,03	12,45	18,65	130,00	79,00	14,40	AFD B 56-56-08-A 231	AFD C 56-56-08-A 231
AFD B 56-56-10	AFD C 56-56-10	21,50	18,10	15,01	15,70	18,65	130,00	79,00	14,40	AFD B 56-56-10-A 231	AFD C 56-56-10-A 231
AFD B 56-56-12	AFD C 56-56-12	25,40	22,10	19,07	18,85	18,65	130,00	95,00	14,40	AFD B 56-56-12-A 231	AFD C 56-56-12-A 231
AFD B 56-56-14	AFD C 56-56-14	28,60	24,10	22,24	22,10	18,65	130,00	95,00	14,40	AFD B 56-56-14-A 231	AFD C 56-56-14-A 231
AFD B 56-56-16	AFD C 56-56-16	31,80	27,10	25,42	25,50	18,65	142,00	95,00	14,40	AFD B 56-56-16-A 231	AFD C 56-56-16-A 231
AFD B 56-56-18	AFD C 56-56-18	34,90	30,10	28,60	27,35	18,65	142,00	95,00	14,40	AFD B 56-56-18-A 231	AFD C 56-56-18-A 231
AFD B 56-56-20	AFD C 56-56-20	38,10	33,10	31,77	30,40	20,25	142,00	111,00	16,00	AFD B 56-56-20-A 231	AFD C 56-56-20-A 231
AFD B 56-56-22	AFD C 56-56-22	41,30	36,10	34,94	33,30	20,25	142,00	111,00	16,00	AFD B 56-56-22-A 231	AFD C 56-56-22-A 231
AFD B 56-56-24	AFD C 56-56-24	44,50	41,10	38,12	36,80	21,10	142,00	111,00	16,80	AFD B 56-56-24-A 231	AFD C 56-56-24-A 231

Male contact

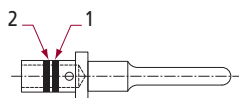

Female contact

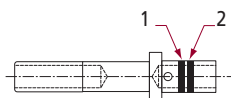

Wire strip length



CONTACTS							CABLES		
Commercial reference Codified	Former code	Type	AWG size	Index	Remarks	Color code 1 2	Section in mm ²	AWG wire	Ø over sheath
006-0937-20 A	0641-10-2059 C	P	20	-	-	red red	0,22 to 0,60	20 to 24	1,01 to 2,10
006-0912-20 A	0603-34-2059 C	S	20	-	-	red red	0,22 to 0,60	20 to 24	1,01 to 2,10
006-0972-20 A	0641-24-2059 C	P	20	-	reduced bucket contact	red black	0,055 to 0,15	26 to 30	1,01 to 2,10
006-0973-20 A	0603-21-2059 C	S	20	-	reduced bucket contact	red black	0,055 to 0,15	26 to 30	1,01 to 2,10
006-0044-20 A	DF 06-044-20 C	P	20	-	enlarged bucket contact	red purple	0,38 to 0,93	18 to 22	1,01 to 2,10
006-0055-20 A	DF 06-A 055-20 C	S	20	-	enlarged bucket contact	red purple	0,38 to 0,93	18 to 22	1,01 to 2,10
006-0982-20	0641-14-2000	P	20	-	chromel contact	mark Ch	0,22 to 0,60	20 to 24	1,01 to 2,10
006-0985-20	0603-16-2000	S	20	-	chromel contact	mark Ch	0,22 to 0,60	20 to 24	1,01 to 2,10
025-0404-20		P	20	-	chromel contact	mark Ch	0,38 to 0,93	18 to 22	1,01 to 2,10
025-0405-20		S	20	-	chromel contact	mark Ch	0,38 to 0,93	18 to 22	1,01 to 2,10
006-0983-20	0641-15-2000	P	20	-	alumel contact	mark Al	0,38 to 0,93	18 to 22	1,01 to 2,10
006-0984-20	0603-15-2000	S	20	-	alumel contact	mark Al	0,38 to 0,93	18 to 22	1,01 to 2,10
025-0402-20		P	20	-	alumel contact	mark Al	0,38 to 0,93	18 to 22	1,01 to 2,10
025-0403-20		S	20	-	alumel contact	mark Al	0,38 to 0,93	18 to 22	1,01 to 2,10
006-1060-20		P	20	-	constantan contact	- -	0,22 to 0,60	20 to 24	1,01 to 2,10
006-1062-20		S	20	-	constantan contact	- -	0,22 to 0,60	20 to 24	1,01 to 2,10
025-0406-20		P	20	-	constantan contact	- -	0,38 to 0,93	18 to 22	1,01 to 2,10
025-0407-20		S	20	-	constantan contact	- -	0,38 to 0,93	18 to 22	1,01 to 2,10
006-0937-16 A	0641-12-1659 C	P	16	-	-	blue blue	0,60 to 1,34	16 to 20	1,35 to 2,62
006-0912-16 A	0603-33-1659 C	S	16	-	-	blue blue	0,60 to 1,34	16 to 20	1,35 to 2,62
006-1102-16 A		P	16	-	enlarged bucket contact	blue orange	1,91	14	1,35 to 2,62
006-1104-16 A		S	16	-	enlarged bucket contact	blue orange	1,91	14	1,35 to 2,62
025-0870-16 A		P	16	-	reduced bucket contact	blue black	0,055 to 0,15	26 to 30	1,35 to 2,62
025-0871-16 A		S	16	-	reduced bucket contact	blue black	0,055 to 0,15	26 to 30	1,35 to 2,62
006-1168-16	109 026-16	P	16	-	reduced bucket contact	blue red	0,22 to 0,60	20 to 24	1,01 to 2,10
006-1169-16	109 027-16	S	16	-	reduced bucket contact	blue red	0,22 to 0,60	20 to 24	1,01 to 2,10
006-0937-12 A	0641-32-1259 C	P	12	-	-	yellow yellow	1,91 to 3,18	12 to 14	2,51 to 4,01
006-0912-12 A	0603-32-1259 C	S	12	-	-	yellow yellow	1,91 to 3,18	12 to 14	2,51 to 4,01
006-1157-12 A	109 028 A	P	12	-	reduced bucket contact	yellow blue	0,60 to 1,34	16 to 20	1,34 to 2,61
006-1159-12 A	109 029 A	S	12	-	reduced bucket contact	yellow blue	0,60 to 1,34	16 to 20	1,34 to 2,61
005-0893-08	101 -333-59	P	8	8	-	- -	5,30 to 8,98	8 to 10	3,80 to 5,15
005-0896-08	101 -334-59	S	8	8	-	- -	5,30 to 8,98	8 to 10	3,80 to 5,15
005-0257-08	DF 05-257-08	P	8	87	reduced bucket contact	- -	5,30	10	3,80 to 5,15
005-0258-08	DF 05-258-08	S	8	87	reduced bucket contact	- -	5,30	10	3,80 to 5,15
006-0041-08	DF 06-A 041-08	P	8	88	-	- -	8,98	8	3,80 to 5,15
006-0040-08	DF 06-A 040-08	S	8	88	-	- -	8,98	8	3,80 to 5,15

Note : Standard contacts supplied with connector
Reference to be order

Connector rear face



TOOLS						
Sealing plug		Crimping tool		Insertion and extraction tool	Extraction tool non wired contacts	
Reference	Color	Reference	Turret	Wired contacts	Reference	Alternate end
4113-4-2001	red	057-0461-00	057-0462-00	M 15570-20	M 15571	105910
4113-4-2001	red	057-0461-00	057-0462-00	M 15570-20	M 15571	105910
4113-4-2001	red	057-0461-00	057-0462-00	M 15570-20	M 15571	105910
4113-4-2001	red	057-0461-00	057-0462-00	M 15570-20	M 15571	105910
4113-4-2001	red	057-0461-00	057-0462-00	M 15570-20	M 15571	105910
4113-4-2001	red	057-0461-00	057-0462-00	M 15570-20	M 15571	105910
4113-4-2001	red	057-0461-00	057-0462-00	M 15570-20	M 15571	105910
4113-4-2001	red	057-0461-00	057-0462-00	M 15570-20	M 15571	105910
4113-4-2001	red	057-0461-00	057-0462-00	M 15570-20	M 15571	105910
0613-1-1601	blue	057-0461-00	057-0462-00	M 15570-16	M 15571	105911
0613-1-1601	blue	057-0461-00	057-0462-00	M 15570-16	M 15571	105911
0613-1-1601	blue	057-0461-00	057-0462-00	M 15570-16	M 15571	105911
0613-1-1601	blue	057-0461-00	057-0462-00	M 15570-16	M 15571	105911
0613-1-1201	yellow	057-0461-00	057-0462-00	M 15570-12	M 15571	105912
0613-1-1201	yellow	057-0461-00	057-0462-00	M 15570-12	M 15571	105912
0613-4-0000	green	057-0461-00	057-0462-00	M 15570-25 (insertion) M 15515-109 (extraction)	-	-
0613-4-0000	green	057-0461-00	057-0462-00	M 15570-25 (insertion) M 15515-109 (extraction)	-	-
0613-4-0000	green	057-0461-00	057-0462-00	M 15570-25 (insertion) M 15515-109 (extraction)	-	-



Wires used				Coax contact Index	CONTACTS							
Reference	G max.	H max.	J max.		Male contacts				Female contacts			
					Complete contact reference	Sub-assembly reference	Inner contact reference	Ø A mm	Complete contact reference	Sub-assembly reference	Inner contact reference	Ø A mm
RG 161/U RG 174/U RG 178/U RG 178 A/U RG 179/U RG 187/U RG 188/U RG 196/U				Standard	106467	106469	106472	0,81	106468	106470	106471	0,81
RG 180/U RG 195/U	3,94	2,62	0,76	1	0603-37-0000	106469	106472	0,81	0603-38-0000	106470	106471	0,81
Special	2,95	1,52	0,97	9	0603-39-0000	106469	0107-028-000	0,99	0603-40-0000	106470	4141-7-2600	0,99
50 PPDT	3,90	2	0,70	F1	DF 05-A065-00-0059	106469	106472	0,81	DF 05-A066-00-0059	106470	106471	0,81

Note : Standard contacts supplied with connector
 For wiring of coax contacts imperatively use the Directions for Wiring n° NC 025 011*

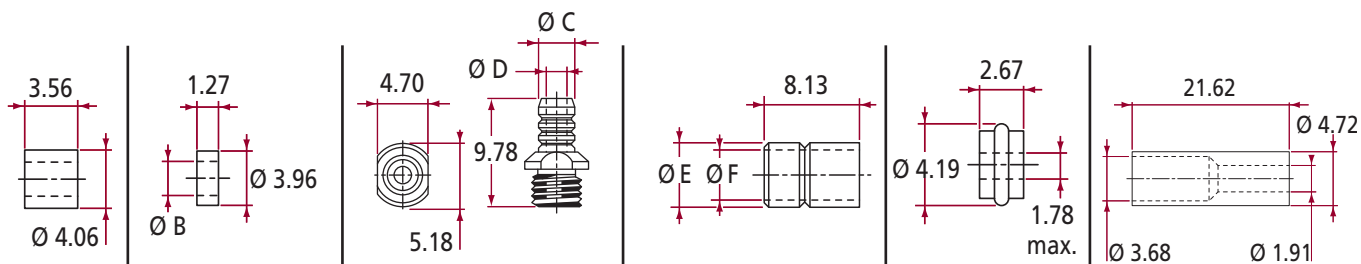

COMMON PARTS										
Grommet reference	Insert reference	Ø B ± 0,05	Supporting sleeve reference	Ø C ± 0,05	Ø D ± 0,02	Crimping sleeve reference	Ø E	Ø F	Sealing sleeve reference	Sealing sleeve reference
105172	0614-1-0000	1,78	105551	2,36	1,67	5121-3-2601	3,91	3,04	-	100368
105172	0614-1-0001	2,74	105552	3,51	2,74	5121-3-2606	5,13	4,11	-	-
105172	0614-1-0000	1,78	105551	2,36	1,67	5121-3-2601	3,91	3,04	-	100368
105172	0614-1-0001	2,74	DF 05-063-000	3,51	2,12	0108-002-001	5,10	4	207/8	-

TOOLS FOR COAX					
Coax index	External contact crimping tool	Positioner	Sleeve crimping tool	Insertion tool	Extraction tool
Standard	057-0463-00	057-0464-00	20053	M 15570-25	M 15570-25
1	057-0463-00	057-0464-00	20052	M 15570-25	M 15570-25
9	057-0463-00	057-0464-00	20053	M 15570-25	M 15570-25
F 1	057-0463-00	057-0464-00	20055	M 15570-25	M 15570-25

■ For cable clamp

Size shell	Main bushing	Middle bushing		
08	 10 006-0005-08			
10	 10 006-0005-10			
12	 10 006-0005-12	 Ø 5.6 47.5 006-0006-12		
14	 Ø 11.1 10 006-0005-14	 Ø 7.9 44 006-0006-14	 006-0006-12	
16	 Ø 11.1 10 006-0005-16	 006-0006-14	 006-0006-12	
18	 Ø 14.3 10 006-0005-18	 Ø 11.1 40.5 006-0006-18	 006-0006-14	 006-0006-12
20	 Ø 15.9 10 006-0005-20	 Ø 14.3 37 006-0006-20	 006-0006-18	 006-0006-14
22	 Ø 19 10 006-0005-22	 Ø 15.9 33.5 006-0006-22	 006-0006-20	 006-0006-18
24	 Ø 23.8 10 006-0005-24	 Ø 19 30 006-0006-24	 006-0006-22	 006-0006-20



Mechanical

Materials	Shell	: Steel
	Plating	: Tin over nickel plating
Insert		: Compression glass ; silicone gasket
Insert retention in shell		: The glass can withstand 70 bars of pressure differential without loss of mechanical or electrical characteristics
Contacts	Type	: Solder type
	Finish	: Gold as per MIL-G 45204
Durability		: 500 full coupling and uncoupling cycles
Temperature		: - 55° C to + 200° C
Air leakage		: Leakage inferior to $\leq 1 \times 10^{-7} \text{ cm}^3 / \text{hour}$ under a 1 bar differential pressure
Physical Shocks		: 50 G in the 3 axes

Electrical

Withstanding voltage	at sea level	: Service 1 : 1500 V 50 Hz (R.M.S) Service 2 : 2300 V 50 Hz (R.M.S)
	in altitude at 15000 m	: Service 1 : 500 V Service 2 : 750 V
	in altitude at 21000 m	: Service 1 : 375 V Service 2 : 500 V
	in altitude at 33000 m	: Service 1 : 200 V Service 2 : 200 V
Insulation resistance		: Higher than 5000 M Ω at 20° C at 65 % R.H
Contacts maximum current		: Size 20 : 5 A. Size 16 : 10 A. Size 12 : 17 A.
Contact millivolt drop		: Size 20 : 75 mv at 5 A. Size 16 : 100 mv at 10 A. Size 12 : 100 mv at 17 A.

Square flange receptacle

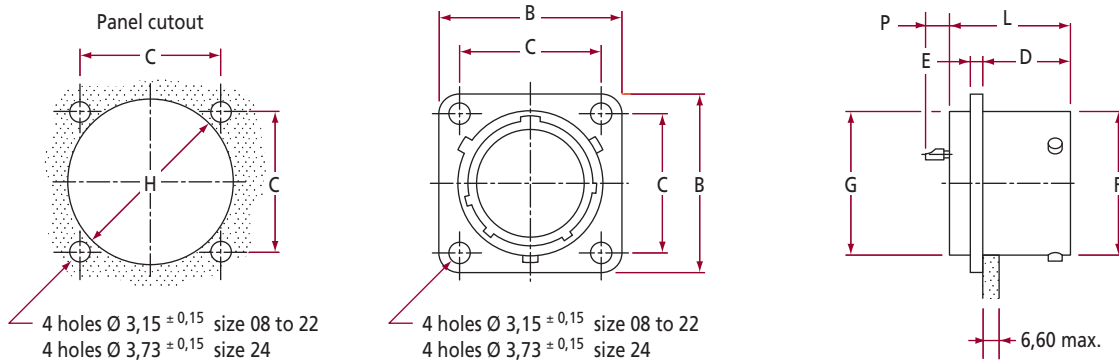

Reference	B	C	D	E	F	G	L	P max. Sizes		H
	max.	± 0,1	± 0,15	max.	max.	max.	max.	20	16-12	+0 -0,2
DBC 50H-08-**-P-*	21,00	15,08	14,95	1,60	12,03	14,30	20,35	4,55	6,30	14,70
DBC 50H-10-**-P-*	24,20	18,26	14,95	1,60	15,01	17,10	20,35	4,55	6,30	17,50
DBC 50H-12-**-P-*	26,55	20,62	14,95	1,60	19,07	19,90	20,35	4,55	6,30	20,30
DBC 50H-14-**-P-*	28,95	23,02	14,95	1,60	22,24	23,05	20,35	4,55	6,30	23,45
DBC 50H-16-**-P-*	31,30	24,58	14,95	1,60	25,42	26,25	20,35	4,55	6,30	26,65
DBC 50H-18-**-P-*	33,70	26,98	14,95	1,60	28,60	29,40	20,35	4,55	6,30	29,80
DBC 50H-20-**-P-*	36,85	29,36	16,55	2,40	31,77	31,80	21,95	4,55	6,30	32,20
DBC 50H-22-**-P-*	39,95	31,76	16,55	2,40	34,94	34,95	22,75	3,70	5,50	35,35
DBC 50H-24-**-P-*	43,15	34,92	16,55	2,40	38,12	38,15	22,75	3,70	5,50	38,55

Single hole receptacle

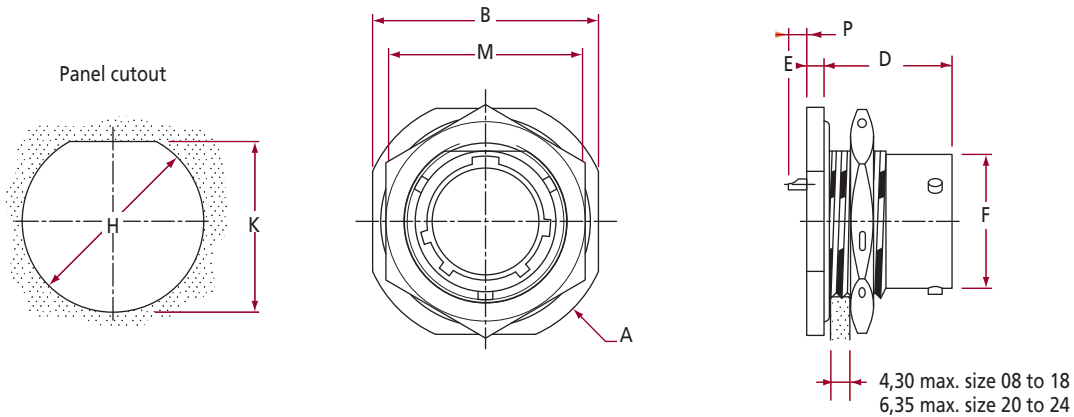

Reference	A	B	D	E	F	H	K	M	P max. Sizes	
	max.	max.	± 0,15	max.	max.	+0 -0,2	+0 -0,2	max.	20	16-12
DBC 54H-08-**-P-*	27,35	24,20	17,78	2,85	12,03	14,65	13,85	19,20	3,40	5,20
DBC 54H-10-**-P-*	30,55	27,35	17,78	2,85	15,01	17,80	17,05	22,37	3,40	5,20
DBC 54H-12-**-P-*	35,30	32,15	17,78	2,85	19,07	22,55	21,15	27,12	3,40	5,20
DBC 54H-14-**-P-*	38,50	35,30	17,78	2,85	22,24	25,70	24,30	30,30	3,40	5,20
DBC 54H-16-**-P-*	41,65	38,50	17,78	2,85	25,42	28,90	27,45	33,47	3,40	5,20
DBC 54H-18-**-P-*	44,80	41,65	17,78	2,85	28,60	32,05	30,65	36,67	3,40	5,20
DBC 54H-20-**-P-*	49,60	46,40	19,43	3,70	31,77	35,25	33,80	39,82	2,55	2,55
DBC 54H-22-**-P-*	52,75	49,60	19,43	3,70	34,94	38,40	37,00	43,02	2,55	2,55
DBC 54H-24-**-P-*	55,95	52,75	20,17	3,70	38,12	41,60	40,15	46,17	2,55	2,55

■ Solder receptacle

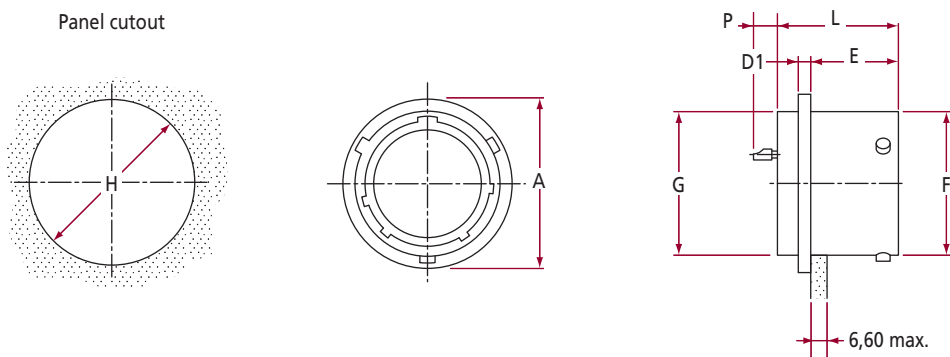

Reference	A	D1	E	F	G	H	L	P max. Sizes	
								20	16-12
DBC 53H-08-**-P-*	16,15	4,00	0,90	12,03	14,30	14,70	20,35	4,55	6,30
DBC 53H-10-**-P-*	19,30	4,00	0,90	15,01	17,50	17,10	20,35	4,55	6,30
DBC 53H-12-**-P-*	21,70	4,00	0,90	19,07	19,90	20,30	20,35	4,55	6,30
DBC 53H-14-**-P-*	24,90	4,00	0,90	22,24	23,45	23,05	20,35	4,55	6,30
DBC 53H-16-**-P-*	28,05	4,00	0,90	25,42	26,25	26,65	20,35	4,55	6,30
DBC 53H-18-**-P-*	31,20	4,00	0,90	28,60	29,40	29,80	20,35	4,55	6,30
DBC 53H-20-**-P-*	33,60	4,00	0,90	31,77	31,80	32,20	21,95	4,55	6,30
DBC 53H-22-**-P-*	36,80	4,80	0,90	34,94	34,95	35,35	22,75	3,70	5,50
DBC 53H-24-**-P-*	40,00	4,80	0,90	38,12	38,15	38,55	22,75	3,70	5,50



CONNECTEURS ELECTRIQUES DEUTSCH

17, rue Lavoisier z.i. n° 2 B.P. 117 27091 EVREUX CEDEX 09 (FRANCE) - Tél.: +33 (0)2 32 23 57 00 - Fax : +33 (0)2 32 23 58 00
E-mail : ced@deutsch.net - Web : www.deutsch.net - Réf.: CC 011-21 E Edition Mars 2008