

## Features

- Surface mount
- 1:1 Impedance ratio
- Centre tap on Secondary
- Suitable for DOCSIS 3.0
- 260°C reflow compatible
- RoHS\* compliant, lead free
- Available on tape and reel.

## Description

M/A Com's MABA-007532-CF18A0 is a 1:1 RF Flux coupled transformer in a low cost, surface mount package. Ideally suited for broadband CATV applications.

## Schematic

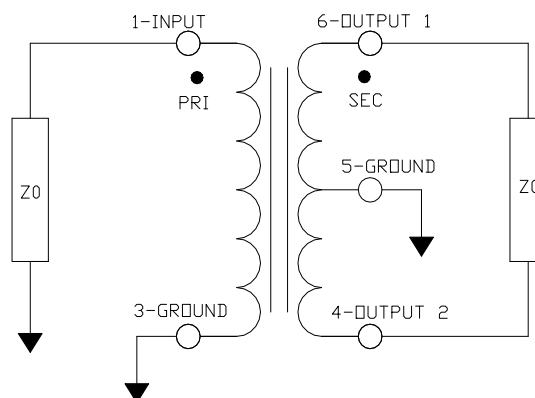

## Case style: SM-138

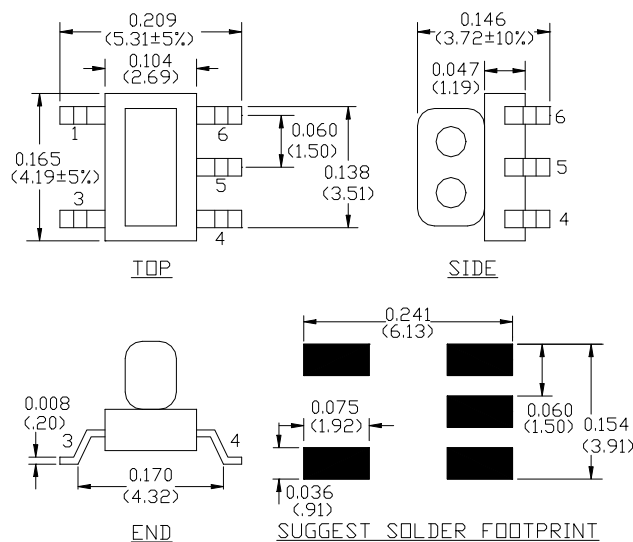

## Pin configuration

Pin no.	Function
1	Primary Dot
3	Primary
4	Secondary
5	Secondary Centre Tap
6	Secondary dot

Dimensions in inches [mm] Tolerance: .xx ± .02, .xxx ± .010, unless otherwise stated

## Ordering information

Part number	Description
MABA-007532-CF18A0	2000 piece reel
MABA-007532-CF18TB	Customer Test Board

Note: Reference Application Note **M513** for reel size information.

\* Restrictions on Hazardous Substances, European Union Directive 2002/95/EC.

1

**ADVANCED:** Data Sheets contain information regarding a product M/A-COM Technology Solutions is considering for development. Performance is based on target specifications, simulated results, and/or prototype measurements. Commitment to develop is not guaranteed.  
**PRELIMINARY:** Data Sheets contain information regarding a product M/A-COM Technology Solutions has under development. Performance is based on engineering tests. Specifications are typical. Mechanical outline has been fixed. Engineering samples and/or test data may be available. Commitment to produce in volume is not guaranteed.

• **North America** Tel: 800.366.2266 • **Europe** Tel: +353.21.244.6400  
 • **India** Tel: +91.80.4155721 • **China** Tel: +86.21.2407.1588  
 Visit [www.macomtech.com](http://www.macomtech.com) for additional data sheets and product information.

M/A-COM Technology Solutions Inc. and its affiliates reserve the right to make changes to the product(s) or information contained herein without notice.

Transformer, 1:1 Flux Coupled Transformer  
5 to 200 MHz

M/A-COM Products  
Released, Rev. V2

**Electrical Specifications:  $T_A = 25^\circ\text{C}$ , 0dBm,  $Z_0 = 75\Omega$**

Parameter	Test Conditions	Units	Min	Typ	Max
Insertion Loss	5 - 60 MHz	dB	-	0.3	0.5
	60 - 150 MHz	dB	-	0.4	0.8
	150 - 200 MHz	dB	-	0.7	1.1
Amplitude Unbalance (Nominal 0dB)	5 - 60 MHz	dB	-	0.0	$\pm 0.1$
	60 - 200 MHz	dB	-	0.2	$\pm 0.6$
Phase Unbalance (Nominal 180°)	5 - 60 MHz	°	-	0.1	$\pm 2.0$
	60 - 200 MHz	°	-	0.3	$\pm 4.0$
Input Return Loss	5 - 60 MHz	dB	20	31	-
	60 - 200 MHz	dB	10	17	-

## Absolute Maximum Ratings <sup>1,2</sup>

Parameter	Absolute maximum
Input power	At least +28dBm (631mW)
DC current (tested at 5V)	At least 600mA
Operating Temperature	-40°C to +85°C
Storage Temperature	-55°C to +100°C

1. Exceeding any one or combination of these limits may cause permanent damage to this device.
2. M/A-COM does not recommend sustained operation near these survivability limits.

Transformer, 1:1 Flux Coupled Transformer  
5 to 200 MHz

M/A-COM Products  
Released, Rev. V2

Typical Performance Curves:  $T_A = 25^\circ\text{C}$ , 0dBm,  $Z_0 = 75\Omega$

Insertion Loss 1: (Pin 1 to 6)

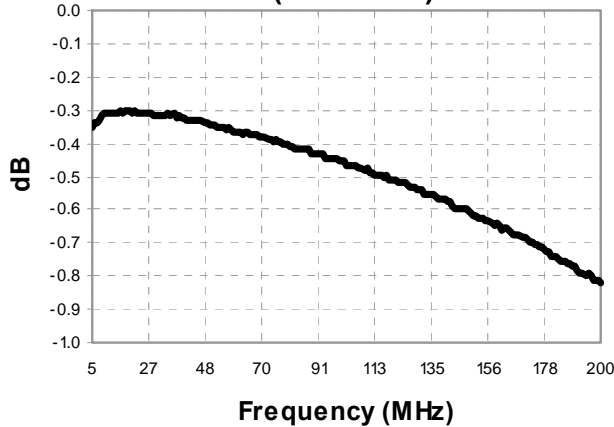

Insertion Loss 2: (Pin 1 to 4)

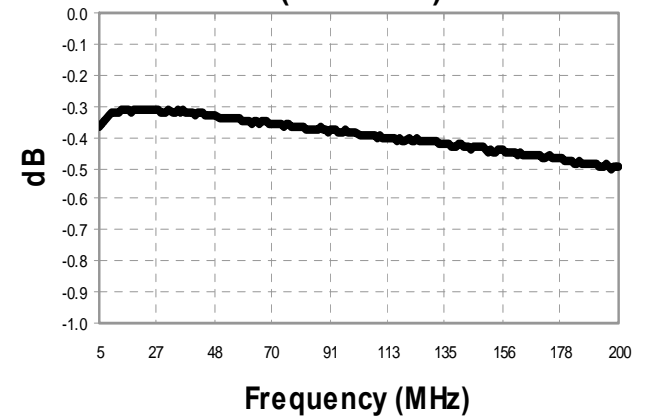

Amplitude Balance

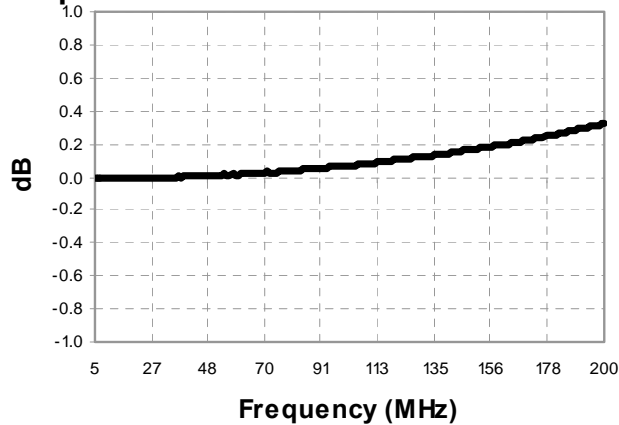

Phase Balance

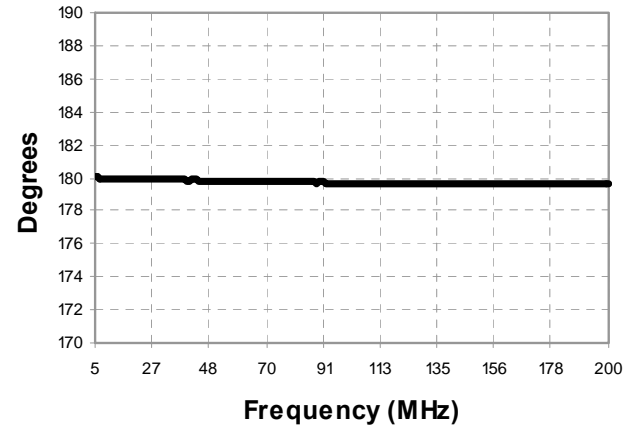

Return Loss: Input

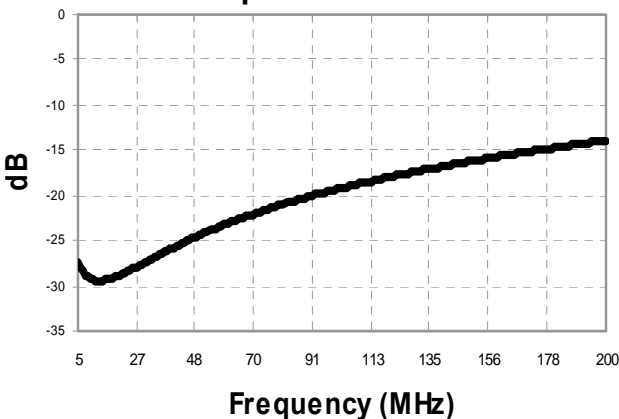

**ADVANCED:** Data Sheets contain information regarding a product M/A-COM Technology Solutions is considering for development. Performance is based on target specifications, simulated results, and/or prototype measurements. Commitment to develop is not guaranteed.

**PRELIMINARY:** Data Sheets contain information regarding a product M/A-COM Technology Solutions has under development. Performance is based on engineering tests. Specifications are typical. Mechanical outline has been fixed. Engineering samples and/or test data may be available. Commitment to produce in volume is not guaranteed.

• **North America** Tel: 800.366.2266 • **Europe** Tel: +353.21.244.6400  
 • **India** Tel: +91.80.4155721 • **China** Tel: +86.21.2407.1588  
 Visit [www.macomtech.com](http://www.macomtech.com) for additional data sheets and product information.

M/A-COM Technology Solutions Inc. and its affiliates reserve the right to make changes to the product(s) or information contained herein without notice.

# Mouser Electronics

Authorized Distributor

Click to View Pricing, Inventory, Delivery & Lifecycle Information:

[MACOM:](#)

[MABA-007532-CF18A0](#)