

# LM2670 SIMPLE SWITCHER® Power Converter, High-Efficiency, 3A, Step-Down Voltage Regulator With Sync

## 1 Features

- Efficiency up to 94%
- Simple and easy to design with (using off-the-shelf external components)
- 150mΩ DMOS output switch
- 3.3V, 5V, 12V fixed output and adjustable (1.2V to 37V) versions
- 50μA standby current when switched OFF
- ±2% maximum output tolerance over full line and load conditions
- 8V to 40V wide Input voltage range
- External sync clock capability (280kHz to 400kHz)
- 260kHz fixed frequency internal oscillator
- –40 to 125°C operating junction temperature range
- Create a custom design using the [LM2670](#) with the [WEBENCH® Power Designer](#)

## 2 Applications

- Simple-to-design, high efficiency (> 90%) step-down switching regulators
- Efficient System preregulator for linear voltage regulators
- Battery chargers
- Communications and radio equipment regulator with synchronized clock frequency

## 3 Description

The LM2670 series of regulators are monolithic, integrated circuits, which provide all of the active functions for a step-down (buck) switching regulator capable of driving up to 3A loads with excellent line and load regulation characteristics. High efficiency (>90%) is obtained through the use of a low ON-resistance DMOS power switch. The series consists of fixed output voltages of 3.3V, 5V, and 12V output version.

The SIMPLE SWITCHER® power converter concept provides for a complete design using a minimum number of external components. The switching clock frequency can be provided by an internal fixed frequency oscillator (260kHz) or from an externally provided clock in the range of 280kHz to 400kHz which allows the use of physically smaller sized components. A family of standard inductors for use with the LM2670 are available from several manufacturers to greatly simplify the design process. The external sync clock provides direct and precise control of the output ripple frequency for consistent filtering or frequency spectrum positioning.

The LM2670 series also has built-in thermal shutdown, current limiting, and an ON and OFF control input that can power down the regulator to a low 50μA quiescent current standby condition. The output voltage is specified to a ±2% tolerance.

### Package Information

PART NUMBER	PACKAGE <sup>(1)</sup>	PACKAGE SIZE <sup>(2)</sup>
LM2670	KTW (TO-263, 7)	10.1mm × 15.24mm
	NDZ (TO-220, 7)	10.16mm × 8.13mm
	NHM (VSON, 14)	6mm × 5mm

(1) For more information, see [Section 10](#).

(2) The package size (length × width) is a nominal value and includes pins, where applicable.

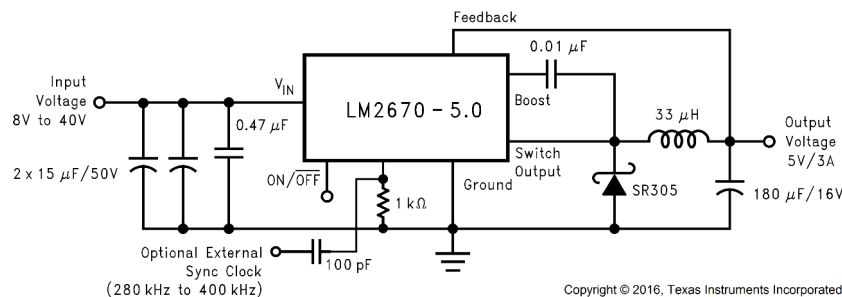

Copyright © 2016, Texas Instruments Incorporated

### Typical Application



## Table of Contents

<b>1 Features</b> .....	1	6.3 Feature Description.....	11
<b>2 Applications</b> .....	1	6.4 Device Functional Modes.....	13
<b>3 Description</b> .....	1	<b>7 Application and Implementation</b> .....	14
<b>4 Pin Configuration and Functions</b> .....	3	7.1 Application Information.....	14
<b>5 Specifications</b> .....	4	7.2 Typical Applications.....	17
5.1 Absolute Maximum Ratings.....	4	7.3 Power Supply Recommendations.....	29
5.2 ESD Ratings.....	4	7.4 Layout.....	29
5.3 Recommended Operating Conditions.....	4	<b>8 Device and Documentation Support</b> .....	31
5.4 Thermal Information.....	5	8.1 Device Support.....	31
5.5 Electrical Characteristics – 3.3 V.....	5	8.2 Documentation Support.....	31
5.6 Electrical Characteristics – 5 V.....	5	8.3 Receiving Notification of Documentation Updates... 31	
5.7 Electrical Characteristics – 12 V.....	6	8.4 Support Resources.....	31
5.8 Electrical Characteristics – ADJ.....	6	8.5 Trademarks.....	31
5.9 Electrical Characteristics – All Output Voltage Versions.....	6	8.6 Electrostatic Discharge Caution.....	32
5.10 Typical Characteristics.....	8	8.7 Glossary.....	32
<b>6 Detailed Description</b> .....	11	<b>9 Revision History</b> .....	33
6.1 Overview.....	11	<b>10 Mechanical, Packaging, and Orderable Information</b> .....	33
6.2 Functional Block Diagram.....	11	10.1 DAP (VSON Package).....	33

## 4 Pin Configuration and Functions

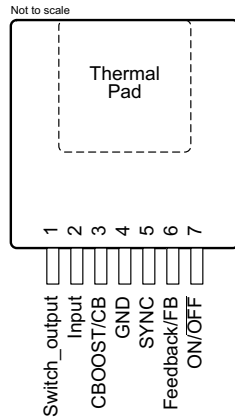

Figure 4-1. KTW Package 7-Pin TO-263 (Top View)

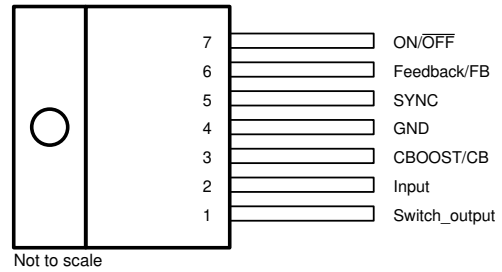

Figure 4-2. NDZ Package 7-Pin TO-220 (Top View)

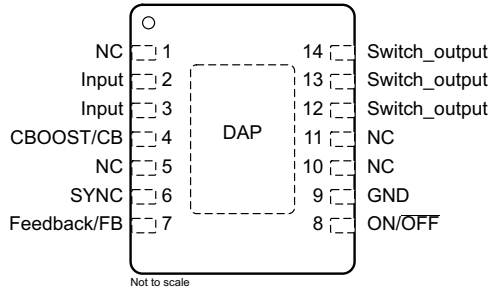

Figure 4-3. NHM Package 14-Pin VSON (Top View)

Table 4-1. Pin Functions

NAME	PIN		TYPE <sup>(1)</sup>	DESCRIPTION
	TO-263, TO-220	VSON		
Switch output	1	12, 13, 14	O	Source pin of the internal High Side FET. This is a switching node. Attached this pin to an inductor and the cathode of the external diode.
Input	2	2, 3	I	Supply input pin to collector pin of high side FET. Connect to power supply and input bypass capacitors $C_{IN}$ . Path from VIN pin to high frequency bypass $C_{IN}$ and GND must be as short as possible.
CBOOST/CB	3	4	I	Boot-strap capacitor connection for high-side driver. Connect a high-quality, 100-nF capacitor from CB to VSW Pin.
GND	4	9	—	Power ground pins. Connect to system ground. Ground pins of $C_{IN}$ and $C_{OUT}$ . Path to CIN must be as short as possible.
SYNC	5	6	I	Synchronization pin. Use this pin to synchronize the frequency to an external clock. The external frequency must be higher than the LM2670 internal oscillation frequency.
Feedback/FB	6	7	I	Feedback sense input pin. Connect to the midpoint of feedback divider to set $V_{OUT}$ for ADJ version or connect this pin directly to the output capacitor for a fixed output version.
ON/ OFF	7	8	I	Enable input to the voltage regulator. High = ON and low = OFF. Pull this pin high or float to enable the regulator.
NC	—	1, 5, 10, 11	—	No connect pins
DAP	—	—	—	All DAP, tab, and paddle connections are at ground potential and must be connected to system ground to allow for correct thermal and electrical performance.

(1) I - input, O = output

## 5 Specifications

### 5.1 Absolute Maximum Ratings

See (1) (2)

		MIN	MAX	UNIT
Input supply voltage			45	V
Soft-start pin voltage		-0.1	6	V
Switch voltage to ground <sup>(3)</sup>		-1	$V_{IN}$	V
Boost pin voltage			$V_{SW} + 8$	V
Feedback pin voltage		-0.3	14	V
Power dissipation		Internally Limited		
Soldering temperature	Wave, 4 s		260	°C
	Infrared, 10 s		240	
	Vapor phase, 75 s		219	
Storage temperature, $T_{stg}$		-65	150	°C

- (1) Stresses beyond those listed under *Absolute Maximum Ratings* may cause permanent damage to the device. These are stress ratings only, which do not imply functional operation of the device at these or any other conditions beyond those indicated under *Recommended Operating Conditions*. Exposure to absolute-maximum-rated conditions for extended periods may affect device reliability.
- (2) If Military/Aerospace specified devices are required, please contact the Texas Instruments Sales Office/Distributors for availability and specifications.
- (3) The absolute maximum specification of the *Switch Voltage to Ground* applies to DC voltage. An extended negative voltage limit of -10 V applies to a pulse of up to 20 ns, -6 V of 60 ns and -3 V of up to 100 ns.

### 5.2 ESD Ratings

			VALUE	UNIT
$V_{(ESD)}$	Electrostatic discharge	Human-body model (HBM), per ANSI/ESDA/JEDEC JS-001 <sup>(1) (2)</sup>	±2000	V

- (1) JEDEC document JEP155 states that 500-V HBM allows safe manufacturing with a standard ESD control process.
- (2) ESD was applied using the human-body model, a 100-pF capacitor discharged through a 1.5-k $\Omega$  resistor into each pin.

### 5.3 Recommended Operating Conditions

		MIN	MAX	UNIT
Supply voltage		8	40	V
Junction temperature, $T_J$		-40	125	°C

## 5.4 Thermal Information

THERMAL METRIC <sup>(1)</sup>		LM2670			UNIT	
		NDZ (TO-220)	KTW (TO-263)	NHM (VSON)		
		7 PINS	7 PINS	14 PINS		
R <sub>θJA</sub>	Junction-to-ambient thermal resistance	See <sup>(2)</sup>	65	—	—	°C/W
		See <sup>(3)</sup>	45	—	—	
		See <sup>(4)</sup>	—	56	—	
		See <sup>(5)</sup>	—	35	—	
		See <sup>(6)</sup>	—	26	—	
		See <sup>(7)</sup>	—	—	55	
		See <sup>(8)</sup>	—	—	29	
R <sub>θJC(top)</sub>	Junction-to-case (top) thermal resistance		2	2	—	°C/W

- (1) For more information about traditional and new thermal metrics, see the [Semiconductor and IC Package Thermal Metrics application note](#).
- (2) Junction to ambient thermal resistance (no external heat sink) for the 7-lead TO-220 package mounted vertically, with ½ inch leads in a socket, or on a PCB with minimum copper area.
- (3) Junction to ambient thermal resistance (no external heat sink) for the 7-lead TO-220 package mounted vertically, with ½ inch leads soldered to a PCB containing approximately 4 square inches of (1 oz.) copper area surrounding the leads.
- (4) Junction to ambient thermal resistance for the 7-lead DDPAK mounted horizontally against a PCB area of 0.136 square inches (the same size as the DDPAK package) of 1 oz (0.0014 in thick) copper.
- (5) Junction to ambient thermal resistance for the 7-lead DDPAK mounted horizontally against a PCB area of 0.4896 square inches (3.6 times the area of the DDPAK package) of 1 oz (0.0014 in thick) copper.
- (6) Junction to ambient thermal resistance for the 7-lead DDPAK mounted horizontally against a PCB copper area of 1.0064 square inches (7.4 times the area of the DDPAK 3 package) of 1 oz (0.0014 in thick) copper. Additional copper area reduces thermal resistance further.
- (7) Junction to ambient thermal resistance for the 14-lead VSON mounted on a PCB copper area equal to the die attach paddle.
- (8) Junction to ambient thermal resistance for the 14-lead VSON mounted on a PCB copper area using 12 vias to a second layer of copper equal to die attach paddle. Additional copper area reduces thermal resistance further. For layout recommendations, see Application Note [AN-1187 Leadless Leadfram Package \(LLP\)](#).

## 5.5 Electrical Characteristics – 3.3 V

Specifications apply for T<sub>A</sub> = T<sub>J</sub> = 25°C unless otherwise noted.

PARAMETER	TEST CONDITIONS	MIN <sup>(1)</sup>	TYP <sup>(2)</sup>	MAX <sup>(1)</sup>	UNIT	
V <sub>OUT</sub>	Output voltage V <sub>IN</sub> = 8 V to 40 V, 100 mA ≤ I <sub>OUT</sub> ≤ 3 A		3.234	3.3	3.366	V
		over the entire junction temperature range of operation –40°C to 125°C	3.201		3.399	
η	Efficiency V <sub>IN</sub> = 12 V, I <sub>LOAD</sub> = 3 A		86%			

- (1) All room temperature limits are 100% tested during production with T<sub>A</sub> = T<sub>J</sub> = 25°C. All limits at temperature extremes are specified through correlation using standard Quality Control (SQC) methods. All limits are used to calculate Average Outgoing Quality Level (AOQL).
- (2) Typical values are determined with T<sub>A</sub> = T<sub>J</sub> = 25°C and represent the most likely norm.

## 5.6 Electrical Characteristics – 5 V

PARAMETER	TEST CONDITIONS	MIN <sup>(1)</sup>	TYP <sup>(2)</sup>	MAX <sup>(1)</sup>	UNIT	
V <sub>OUT</sub>	Output voltage V <sub>IN</sub> = 8 V to 40 V, 100 mA ≤ I <sub>OUT</sub> ≤ 3 A		4.9	5	5.1	V
		over the entire junction temperature range of operation –40°C to 125°C	4.85		5.15	
η	Efficiency V <sub>IN</sub> = 12 V, I <sub>LOAD</sub> = 3 A		88%			

- (1) All room temperature limits are 100% tested during production with T<sub>A</sub> = T<sub>J</sub> = 25°C. All limits at temperature extremes are specified through correlation using standard Quality Control (SQC) methods. All limits are used to calculate Average Outgoing Quality Level (AOQL).
- (2) Typical values are determined with T<sub>A</sub> = T<sub>J</sub> = 25°C and represent the most likely norm.

## 5.7 Electrical Characteristics – 12 V

PARAMETER	TEST CONDITIONS	MIN <sup>(1)</sup>	TYP <sup>(2)</sup>	MAX <sup>(1)</sup>	UNIT
V <sub>OUT</sub> Output voltage	V <sub>IN</sub> = 15 V to 40 V, 100 mA ≤ I <sub>OUT</sub> ≤ 3 A over the entire junction temperature range of operation –40°C to 125°C	11.76	12	12.24	V
		11.64		12.36	
η Efficiency	V <sub>IN</sub> = 24 V, I <sub>LOAD</sub> = 3 A		94%		

(1) All room temperature limits are 100% tested during production with T<sub>A</sub> = T<sub>J</sub> = 25°C. All limits at temperature extremes are specified through correlation using standard Quality Control (SQC) methods. All limits are used to calculate Average Outgoing Quality Level (AOQL).

(2) Typical values are determined with T<sub>A</sub> = T<sub>J</sub> = 25°C and represent the most likely norm.

## 5.8 Electrical Characteristics – ADJ

PARAMETER	TEST CONDITIONS	MIN <sup>(1)</sup>	TYP <sup>(2)</sup>	MAX <sup>(1)</sup>	UNIT
V <sub>FB</sub> Feedback voltage	V <sub>IN</sub> = 8 V to 40 V, 100 mA ≤ I <sub>OUT</sub> ≤ 3 A V <sub>OUT</sub> programmed for 5V Over the entire junction temperature range of operation –40°C to 125°C	1.186	1.21	1.234	V
		1.174		1.246	
η Efficiency	V <sub>IN</sub> = 12 V, I <sub>LOAD</sub> = 3 A		88%		

## 5.9 Electrical Characteristics – All Output Voltage Versions

Specifications are for T<sub>A</sub> = T<sub>J</sub> = 25°C unless otherwise specified. Unless otherwise specified V<sub>IN</sub> = 12 V for the 3.3 V, 5 V and Adjustable versions, and V<sub>IN</sub> = 24 V for the 12 V version.

PARAMETER	TEST CONDITIONS	MIN	TYP	MAX	UNIT
<b>DEVICE PARAMETERS</b>					
I <sub>Q</sub> Quiescent current	V <sub>FEEDBACK</sub> = 8 V for 3.3-V, 5-V, and ADJ versions, V <sub>FEEDBACK</sub> = 15 V for 12-V Versions		4.2	6	mA
I <sub>STBY</sub> Standby quiescent current	ON/ OFF pin = 0 V over the entire junction temperature range of operation –40°C to 125°C		50	100	μA
				150	
I <sub>CL</sub> Current limit	over the entire junction temperature range of operation – 40°C to 125°C		3.8	4.5	A
			3.6	5.4	
I <sub>L</sub> Output leakage current	V <sub>IN</sub> = 40 V, soft-start pin = 0 V	V <sub>SWITCH</sub> = 0 V		200	μA
		V <sub>SWITCH</sub> = –1 V		16	15
R <sub>DS(ON)</sub> Switch ON-resistance	I <sub>SWITCH</sub> = 3 A		0.15	0.17	Ω
	over the entire junction temperature range of operation –40°C to 125°C			0.29	
f <sub>O</sub> Oscillator frequency	Measured at switch pin over the entire junction temperature range of operation –40°C to 125°C		260		kHz
			225	280	
D Duty cycle	Maximum duty cycle		91%		
	Minimum duty cycle		0%		
I <sub>BIAS</sub> Feedback bias current	V <sub>FEEDBACK</sub> = 1.3 V, ADJ version only		85		nA
V <sub>ON/OFF</sub> ON/OFF threshold voltage	over the entire junction temperature range of operation – 40°C to 125°C		1.4		V
			0.8	2	
I <sub>ON/OFF</sub> ON/OFF input current	ON/ OFF pin = 0 V over the entire junction temperature range of operation –40°C to 125°C		20		μA
				45	

Specifications are for  $T_A = T_J = 25^\circ\text{C}$  unless otherwise specified. Unless otherwise specified  $V_{IN} = 12\text{ V}$  for the 3.3 V, 5 V and Adjustable versions, and  $V_{IN} = 24\text{ V}$  for the 12 V version.

PARAMETER		TEST CONDITIONS	MIN	TYP	MAX	UNIT
$F_{\text{SYNC}}$	Synchronization frequency	$V_{\text{SYNC}}$ (pin 5) = 3.5 V, 50% duty cycle		400		kHz
$V_{\text{SYNC}}$	SYNC threshold voltage			1.4		V

### 5.10 Typical Characteristics

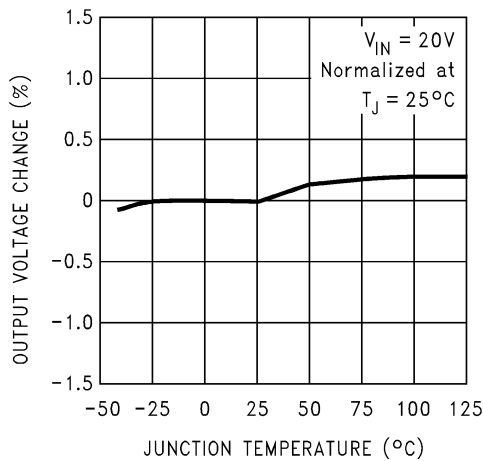

**Figure 5-1. Normalized Output Voltage**

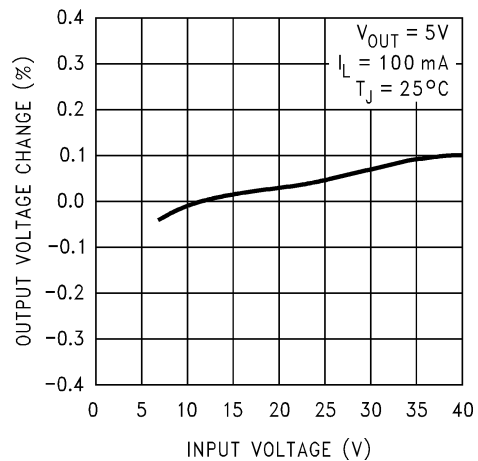

**Figure 5-2. Line Regulation**

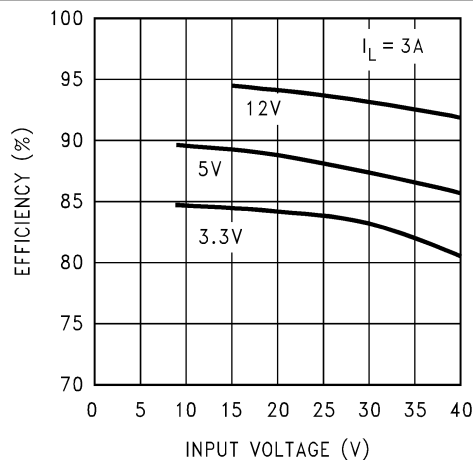

**Figure 5-3. Efficiency vs Input Voltage**

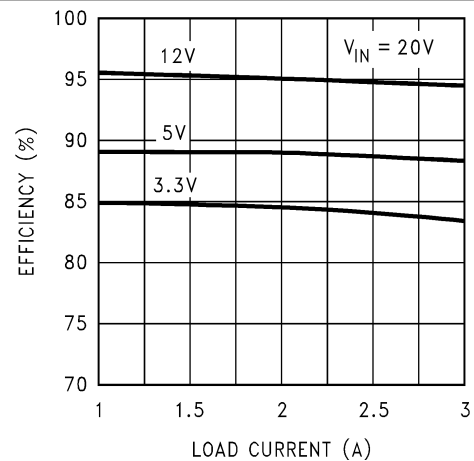

**Figure 5-4. Efficiency vs I\_LOAD**

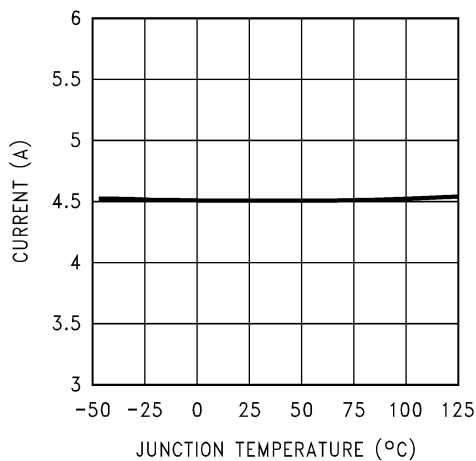

**Figure 5-5. Switch Current Limit**

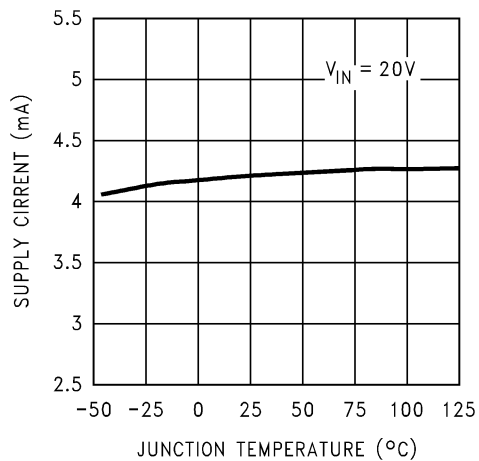

**Figure 5-6. Operating Quiescent Current**

### 5.10 Typical Characteristics (continued)

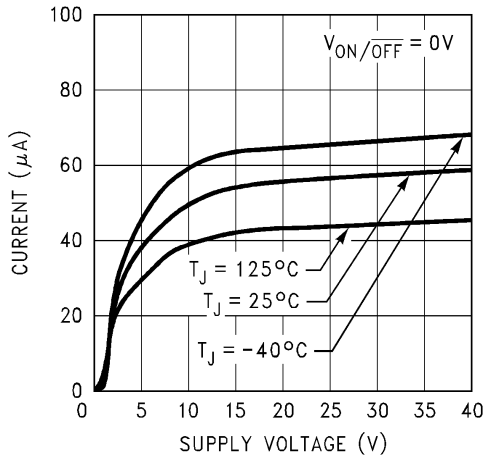

Figure 5-7. Standby Quiescent Current

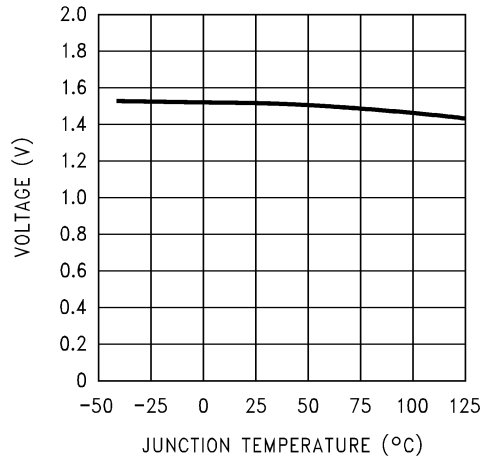

Figure 5-8. ON/OFF Threshold Voltage

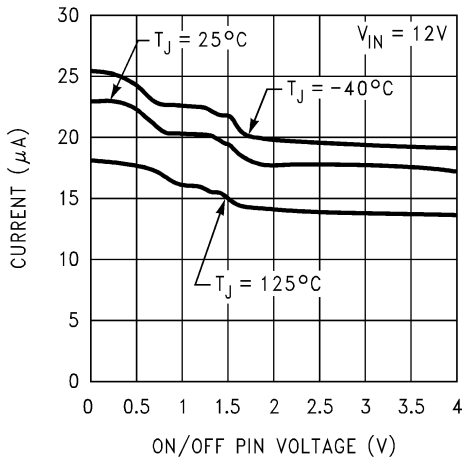

Figure 5-9. ON/OFF Pin Current (Sourcing)

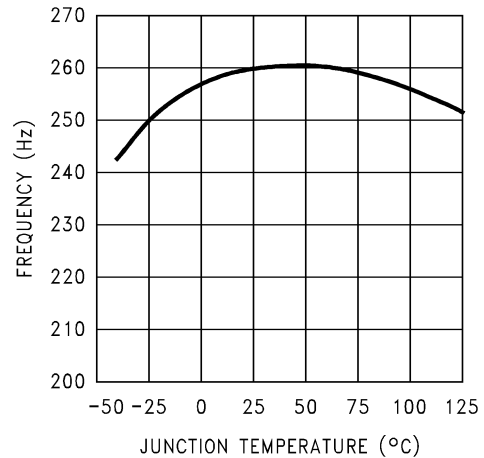

Figure 5-10. Switching Frequency

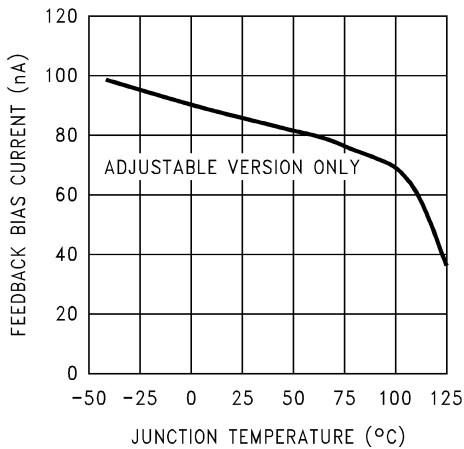
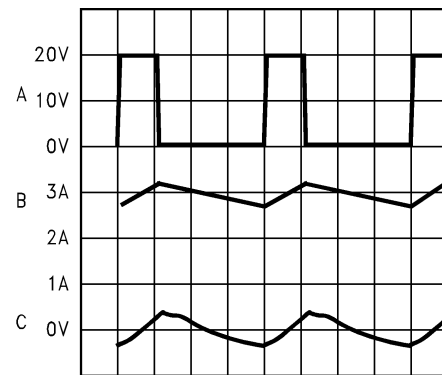

Figure 5-11. Feedback Pin Bias Current



Continuous Mode Switching Waveforms  $V_{IN} = 20\text{ V}$ ,  $V_{OUT} = 5\text{ V}$ ,  $I_{LOAD} = 3\text{ A}$ ,  $L = 33\text{ }\mu\text{H}$ ,  $C_{OUT} = 200\text{ }\mu\text{F}$ ,  $C_{OUT-ESR} = 26\text{ m}\Omega$   
 A:  $V_{SW}$  Pin Voltage, 10 V/div  
 B: Inductor Current, 1 A/div  
 C: Output Ripple Voltage, 20 mV/div AC-Coupled

Figure 5-12. Horizontal Time Base: 1  $\mu\text{s}$ /div

## 5.10 Typical Characteristics (continued)

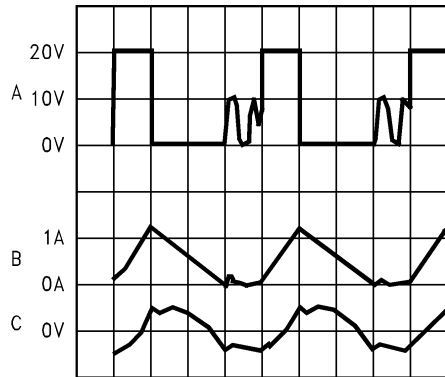

1  $\mu\text{sec}/\text{Div}$

Discontinuous Mode Switching Waveforms  $V_{\text{IN}} = 20\text{ V}$ ,  $V_{\text{OUT}} = 5\text{ V}$ ,  $I_{\text{LOAD}} = 500\text{ mA}$   $L = 10\text{ }\mu\text{H}$ ,  $C_{\text{OUT}} = 400\text{ }\mu\text{F}$ ,  $C_{\text{OUT}}\text{ESR} = 13\text{ m}\Omega$

A:  $V_{\text{SW}}$  Pin Voltage, 10 V/div

B: Inductor Current, 1 A/div

C: Output Ripple Voltage, 20 mV/div AC-Coupled

**Figure 5-13. Horizontal Time Base: 1  $\mu\text{s}/\text{div}$**

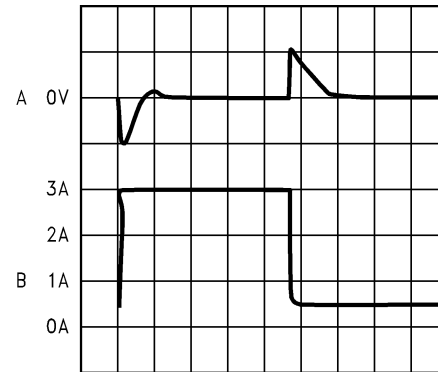

100  $\mu\text{sec}/\text{Div}$

Load Transient Response for Continuous Mode  $V_{\text{IN}} = 20\text{ V}$ ,  $V_{\text{OUT}} = 5\text{ V}$   $L = 33\text{ }\mu\text{H}$ ,  $C_{\text{OUT}} = 200\text{ }\mu\text{F}$ ,  $C_{\text{OUT}}\text{ESR} = 26\text{ m}\Omega$

A: Output Voltage, 100 mV/div, AC-Coupled

B: Load Current: 500-mA to 3-A Load Pulse

**Figure 5-14. Horizontal Time Base: 100  $\mu\text{s}/\text{div}$**

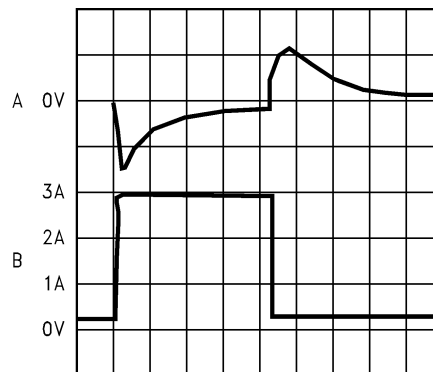

200  $\mu\text{sec}/\text{Div}$

Load Transient Response for Discontinuous Mode  $V_{\text{IN}} = 20\text{ V}$ ,  $V_{\text{OUT}} = 5\text{ V}$ ,  $L = 10\text{ }\mu\text{H}$ ,  $C_{\text{OUT}} = 400\text{ }\mu\text{F}$ ,  $C_{\text{OUT}}\text{ESR} = 13\text{ m}\Omega$

A: Output Voltage, 100 mV/div, AC-Coupled

B: Load Current: 200-mA to 3-A Load Pulse

**Figure 5-15. Horizontal Time Base: 200  $\mu\text{s}/\text{div}$**

## 6 Detailed Description

### 6.1 Overview

The LM2670 provides all of the active functions required for a step-down (buck) switching regulator. The internal power switch is a DMOS power MOSFET to provide power supply designs with high current capability, up to 3 A, and highly efficient operation.

The design support WEBENCH, can also be used to provide instant component selection, circuit performance calculations for evaluation, a bill of materials component list and a circuit schematic for LM2670.

### 6.2 Functional Block Diagram

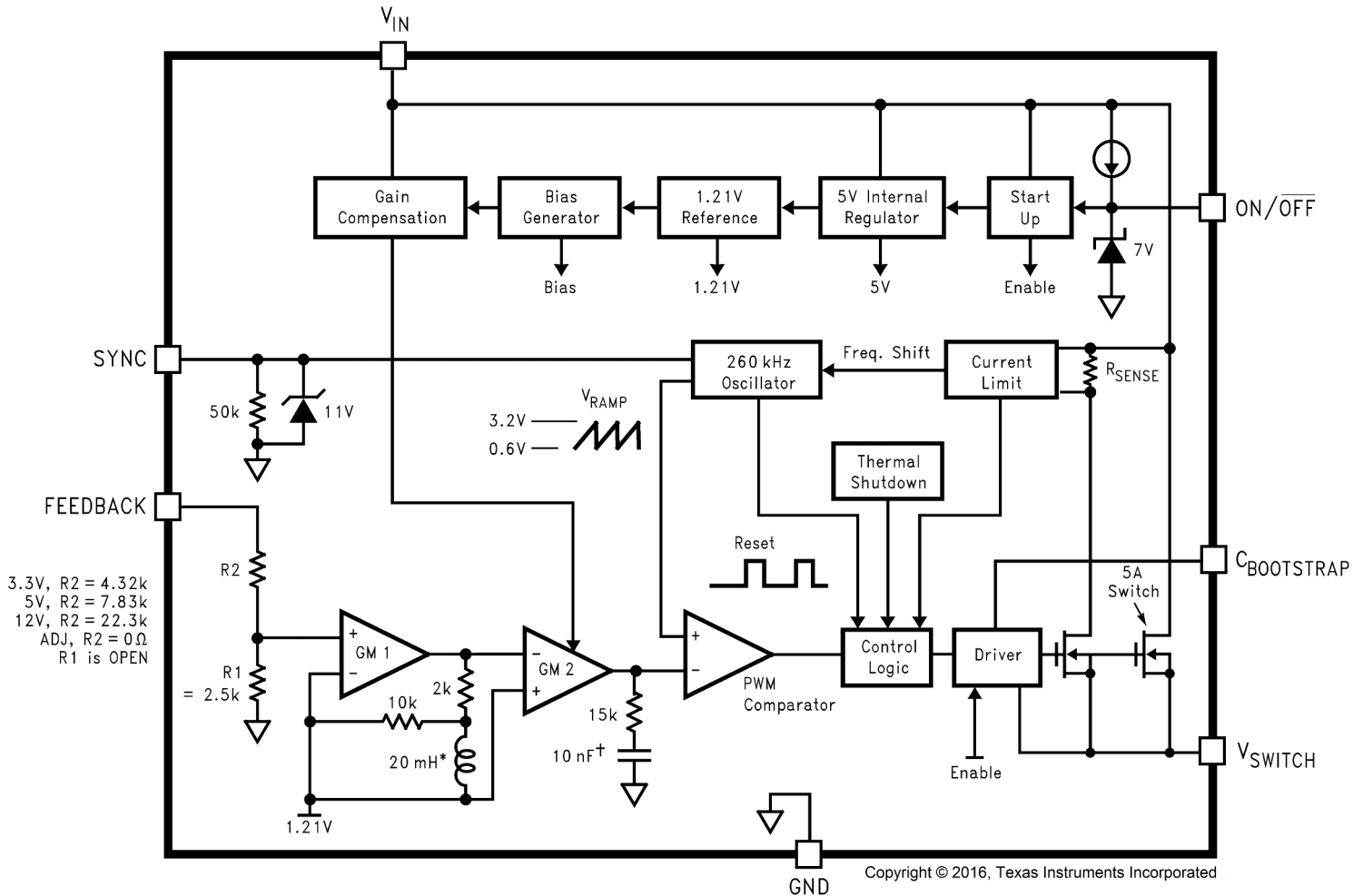

\* Active Inductor Patent Number 5,514,947 † Active Capacitor Patent Number 5,382,918

### 6.3 Feature Description

#### 6.3.1 Switch Output

This is the output of a power MOSFET switch connected directly to the input voltage. The switch provides energy to an inductor, an output capacitor, and the load circuitry under control of an internal pulse-width-modulator (PWM). The PWM controller is internally clocked by a fixed 260-kHz oscillator. In a standard step-down application the duty cycle (Time ON/Time OFF) of the power switch is proportional to the ratio of the power supply output voltage to the input voltage. The voltage on pin 1 switches between  $V_{IN}$  (switch ON) and below ground by the voltage drop of the external Schottky diode (switch OFF).

### 6.3.2 Input

The input voltage for the power supply is connected to pin 2. In addition to providing energy to the load the input voltage also provides bias for the internal circuitry of the LM2670. For ensured performance the input voltage must be in the range of 8 V to 40 V. For best performance of the power supply the input pin must always be bypassed with an input capacitor located close to pin 2.

### 6.3.3 C Boost

A capacitor must be connected from pin 3 to the switch output, pin 1. This capacitor boosts the gate drive to the internal MOSFET above  $V_{IN}$  to fully turn it ON. This minimizes conduction losses in the power switch to maintain high efficiency. The recommended value for C Boost is 0.01  $\mu$ F.

### 6.3.4 Ground

This is the ground reference connection for all components in the power supply. In fast-switching, high-current applications such as those implemented with the LM2670, TI recommends using a broad ground plane to minimize signal coupling throughout the circuit.

### 6.3.5 SYNC

This input allows control of the switching clock frequency. If left open-circuited the regulator will be switched at the internal oscillator frequency, between 225 kHz and 280 kHz. An external clock can be used to force the switching frequency and thereby control the output ripple frequency of the regulator. This capability provides for consistent filtering of the output ripple from system to system as well as precise frequency spectrum positioning of the ripple frequency which is often desired in communications and radio applications. This external frequency must be greater than the LM2670 internal oscillator frequency, which can be as high as 280 kHz, to prevent an erroneous reset of the internal ramp oscillator and PWM control of the power switch. The ramp oscillator is reset on the positive going edge of the sync input signal. TI recommends that the external TTL or CMOS compatible clock (between 0 V and a level greater than 3 V) be AC-coupled to the sync input through a 100-pf capacitor and a 1-k $\Omega$  resistor to ground at pin 5 as shown in [Figure 7-6](#).

When the SYNC function is used, current limit frequency foldback is not active. Therefore, the device may not be fully protected against extreme output short-circuit conditions. See [Additional Application Information](#).

### 6.3.6 Feedback

This is the input to a two-stage high gain amplifier, which drives the PWM controller. It is necessary to connect pin 6 to the actual output of the power supply to set the DC output voltage. For the fixed output devices (3.3-V, 5-V, and 12-V outputs), a direct wire connection to the output is all that is required as internal gain setting resistors are provided inside the LM2670. For the adjustable output version two external resistors are required to set the DC output voltage. For stable operation of the power supply it is important to prevent coupling of any inductor flux to the feedback input.

### 6.3.7 ON/OFF

This input provides an electrical ON/OFF control of the power supply. Connecting this pin to ground or to any voltage less than 0.8 V will completely turn OFF the regulator. The current drain from the input supply when OFF is only 50  $\mu$ A. Pin 7 has an internal pull-up current source of approximately 20  $\mu$ A and a protection clamp Zener diode of 7 V to ground. When electrically driving the ON/  $\overline{\text{OFF}}$  pin the high voltage level for the ON condition must not exceed the 6-V absolute maximum limit. When ON/OFF control is not required pin 7 must be left open circuited.

## 6.4 Device Functional Modes

### 6.4.1 Shutdown Mode

The ON/  $\overline{\text{OFF}}$  pin provides electrical ON and OFF control for the LM2670. When the voltage of this pin is lower than 1.4 V, the device is shutdown mode. The typical standby current in this mode is 50  $\mu\text{A}$ .

### 6.4.2 Active Mode

When the voltage of the ON/  $\overline{\text{OFF}}$  pin is higher than 1.4 V, the device starts switching and the output voltage rises until it reaches a normal regulation voltage.

## 7 Application and Implementation

### Note

Information in the following applications sections is not part of the TI component specification, and TI does not warrant its accuracy or completeness. TI's customers are responsible for determining suitability of components for their purposes, as well as validating and testing their design implementation to confirm system functionality.

### 7.1 Application Information

#### 7.1.1 Design Considerations

Power supply design using the LM2670 is greatly simplified by using recommended external components. A wide range of inductors, capacitors and Schottky diodes from several manufacturers have been evaluated for use in designs that cover the full range of capabilities (input voltage, output voltage, and load current) of the LM2670. A simple design procedure using nomographs and component tables provided in this data sheet leads to a working design with very little effort. Alternately, the WEBENCH® software can be used to generate complete designs. When generating a design, the WEBENCH software uses iterative design procedure and accesses comprehensive databases of components. See [ti.com](http://ti.com) for more details.

The individual components from the various manufacturers called out for use are still just a small sample of the vast array of components available in the industry. While these components are recommended, they are not exclusively the only components for use in a design. After a close comparison of component specifications, equivalent devices from other manufacturers can be substituted for use in an application.

Important considerations for each external component and an explanation of how the nomographs and selection tables were developed follows.

#### 7.1.2 Inductor

The inductor is the key component in a switching regulator. For efficiency the inductor stores energy during the switch ON time and then transfers energy to the load while the switch is OFF.

Nomographs are used to select the inductance value required for a given set of operating conditions. The nomographs assume that the circuit is operating in continuous mode (the current flowing through the inductor never falls to zero). The magnitude of inductance is selected to maintain a maximum ripple current of 30% of the maximum load current. If the ripple current exceeds this 30% limit the next larger value is selected.

The inductors offered have been specifically manufactured to provide proper operation under all operating conditions of input and output voltage and load current. Several part types are offered for a given amount of inductance. Both surface mount and through-hole devices are available. The inductors from each of the three manufacturers have unique characteristics.

- Renco: ferrite stick core inductors; benefits are typically lowest cost and can withstand ripple and transient peak currents above the rated value. These inductors have an external magnetic field, which can generate EMI.
- Pulse Engineering: powdered iron toroid core inductors; these also can withstand higher than rated currents and, being toroid inductors, have low EMI.
- Coilcraft: ferrite drum core inductors; these are the smallest physical size inductors and are available only as surface mount components. These inductors also generate EMI but less than stick inductors.

#### 7.1.3 Output Capacitor

The output capacitor acts to smooth the DC output voltage and also provides energy storage. Selection of an output capacitor, with an associated equivalent series resistance (ESR), impacts both the amount of output ripple voltage and stability of the control loop.

The output ripple voltage of the power supply is the product of the capacitor ESR and the inductor ripple current. The capacitor types recommended in the tables were selected for having low ESR ratings.

In addition, both surface mount tantalum capacitors and through-hole aluminum electrolytic capacitors are offered as solutions.

Impacting frequency stability of the overall control loop, the output capacitance, in conjunction with the inductor, creates a double pole inside the feedback loop. In addition the capacitance and the ESR value create a zero. These frequency response effects together with the internal frequency compensation circuitry of the LM2670 modify the gain and phase shift of the closed-loop system.

As a general rule for stable switching regulator circuits it is desired to have the unity gain bandwidth of the circuit to be limited to no more than one-sixth of the controller switching frequency. With the fixed 260-kHz switching frequency of the LM2670, the output capacitor is selected to provide a unity gain bandwidth of 40 kHz maximum. Each recommended capacitor value has been chosen to achieve this result.

In some cases multiple capacitors are required either to reduce the ESR of the output capacitor, to minimize output ripple (a ripple voltage of 1% of  $V_{OUT}$  or less is the assumed performance condition), or to increase the output capacitance to reduce the closed loop unity gain bandwidth (to less than 40 kHz). When parallel combinations of capacitors are required it has been assumed that each capacitor is the exact same part type.

The RMS current and working voltage (WV) ratings of the output capacitor are also important considerations. In a typical step-down switching regulator, the inductor ripple current (set to be no more than 30% of the maximum load current by the inductor selection) is the current that flows through the output capacitor. The capacitor RMS current rating must be greater than this ripple current. The voltage rating of the output capacitor must be greater than 1.3 times the maximum output voltage of the power supply. If operation of the system at elevated temperatures is required, the capacitor voltage rating can be de-rated to less than the nominal room temperature rating. Careful inspection of the manufacturer's specification for de-rating of working voltage with temperature is important.

#### **7.1.4 Input Capacitor**

Fast changing currents in high current switching regulators place a significant dynamic load on the unregulated power source. An input capacitor helps to provide additional current to the power supply as well as smooth out input voltage variations.

Like the output capacitor, the key specifications for the input capacitor are RMS current rating and working voltage. The RMS current flowing through the input capacitor is equal to one-half of the maximum DC load current so the capacitor must be rated to handle this. Paralleling multiple capacitors proportionally increases the current rating of the total capacitance. The voltage rating must also be selected to be 1.3 times the maximum input voltage. Depending on the unregulated input power source, under light load conditions the maximum input voltage can be significantly higher than normal operation. Consider when selecting an input capacitor.

The input capacitor must be placed very close to the input pin of the LM2670. Due to relative high current operation with fast transient changes, the series inductance of input connecting wires or PCB traces can create ringing signals at the input terminal which can possibly propagate to the output or other parts of the circuitry. It can be necessary in some designs to add a small valued (0.1  $\mu$ F to 0.47  $\mu$ F) ceramic type capacitor in parallel with the input capacitor to prevent or minimize any ringing.

#### **7.1.5 Catch Diode**

When the power switch in the LM2670 turns OFF, the current through the inductor continues to flow. The path for this current is through the diode connected between the switch output and ground. This forward biased diode clamps the switch output to a voltage less than ground. This negative voltage must be greater than  $-1$  V so a low voltage drop (particularly at high current levels) Schottky diode is recommended. Total efficiency of the entire power supply is significantly impacted by the power lost in the output catch diode. The average current through the catch diode is dependent on the switch duty cycle (D) and is equal to the load current times (1-D). Use of a diode rated for much higher current than is required by the actual application helps to minimize the voltage drop and power loss in the diode.

During the switch ON time the diode is reversed biased by the input voltage. The reverse voltage rating of the diode must be at least 1.3 times greater than the maximum input voltage.

### 7.1.6 Boost Capacitor

The boost capacitor creates a voltage used to overdrive the gate of the internal power MOSFET. This improves efficiency by minimizing the on resistance of the switch and associated power loss. For all applications, TI recommends using a 0.01- $\mu$ F, 50-V ceramic capacitor.

### 7.1.7 Sync Components

When synchronizing the LM2670 with an external clock it is recommended to connect the clock to pin 5 through a series 100-pf capacitor and connect a 1-k $\Omega$  resistor to ground from pin 5. This RC network creates a short 100-ns pulse on each positive edge of the clock to reset the internal ramp oscillator. The reset time of the oscillator is approximately 300 ns.

### 7.1.8 Additional Application Information

When the output voltage is greater than approximately 6 V, and the duty cycle at minimum input voltage is greater than approximately 50%, the designer must exercise caution in selection of the output filter components. When an application designed to these specific operating conditions is subjected to a current limit fault condition, it can be possible to observe a large hysteresis in the current limit. This can affect the output voltage of the device until the load current is reduced sufficiently to allow the current limit protection circuit to reset itself.

Under current limiting conditions, the LM267x is designed to respond in the following manner:

1. At the moment when the inductor current reaches the current limit threshold, the ON-pulse is immediately terminated. This happens for any application condition.
2. However, the current limit block is also designed to momentarily reduce the duty cycle to below 50% to avoid subharmonic oscillations, which can cause the inductor to saturate.
3. Thereafter, once the inductor current falls below the current limit threshold, there is a small relaxation time during which the duty cycle progressively rises back above 50% to the value required to achieve regulation.

If the output capacitance is sufficiently *large*, it can be possible that as the output tries to recover, the output capacitor charging current is large enough to repeatedly re-trigger the current limit circuit before the output has fully settled. This condition is exacerbated with higher output voltage settings because the energy requirement of the output capacitor varies as the square of the output voltage ( $\frac{1}{2} CV^2$ ), thus requiring an increased charging current.

A simple test to determine if this condition might exist for a suspect application is to apply a short circuit across the output of the converter, and then remove the shorted output condition. In an application with properly selected external components, the output recovers smoothly.

Practical values of external components that have been experimentally found to work well under these specific operating conditions are  $C_{OUT} = 47 \mu\text{F}$ ,  $L = 22 \mu\text{H}$ . It must be noted that even with these components, for a device's current limit of  $I_{CLIM}$ , the maximum load current under which the possibility of the large current limit hysteresis can be minimized is  $I_{CLIM} / 2$ . For example, if the input is 24 V and the set output voltage is 18 V, then for a desired maximum current of 1.5 A, the current limit of the chosen switcher must be confirmed to be at least 3 A.

Under extreme overcurrent or short-circuit conditions, the LM267X employs frequency foldback in addition to the current limit. If the cycle-by-cycle inductor current increases above the current limit threshold (due to short circuit or inductor saturation for example) the switching frequency is automatically reduced to protect the IC. Frequency below 100 kHz is typical for an extreme short-circuit condition.

## 7.2 Typical Applications

### 7.2.1 Typical Application for All Output Voltage Versions

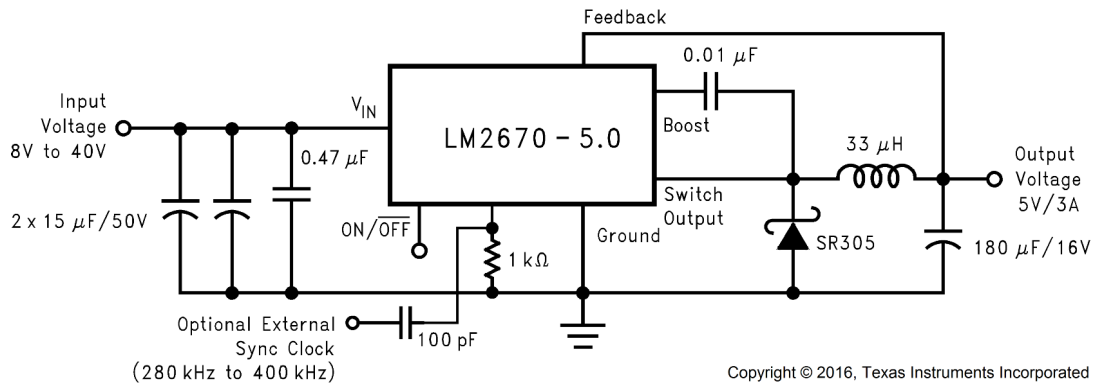

**Figure 7-1. Basic Circuit for All Output Voltage Versions**

#### 7.2.1.1 Design Requirements

Select the power supply operating conditions and the maximum output current and follow below procedures to find the external components for LM2670

#### 7.2.1.2 Detailed Design Procedure

Using the nomographs and tables in this data sheet (or use the available design software at [www.ti.com](http://www.ti.com)) a complete step-down regulator can be designed in a few simple steps.

**Step 1:** Define the power supply operating conditions:

- Required output voltage
- Maximum DC input voltage
- Maximum output load current

**Step 2:** Set the output voltage by selecting a fixed output LM2670 (3.3-V, 5-V, or 12-V applications) or determine the required feedback resistors for use with the adjustable LM2670–ADJ

**Step 3:** Determine the inductor required by using one of the four nomographs, [Figure 7-2](#) through [Figure 7-5](#). [Table 7-3](#) provides a specific manufacturer and part number for the inductor.

**Step 4:** Using [Table 7-5](#) and [Table 7-6](#) (fixed output voltage) or [Table 7-9](#) and [Table 7-10](#) (adjustable output voltage), determine the output capacitance required for stable operation. [Table 7-1](#) or [Table 7-2](#) provide the specific capacitor type from the manufacturer of choice.

**Step 5:** Determine an input capacitor from [Table 7-7](#) or [Table 7-8](#) for fixed output voltage applications. Use [Table 7-1](#) or [Table 7-2](#) to find the specific capacitor type. For adjustable output circuits select a capacitor from [Table 7-1](#) or [Table 7-2](#) with a sufficient working voltage (WV) rating greater than  $V_{IN\ max}$ , and an RMS current rating greater than one-half the maximum load current (2 or more capacitors in parallel can be required).

**Step 6:** Select a diode from [Table 7-4](#). The current rating of the diode must be greater than  $I_{LOAD\ max}$  and the reverse voltage rating must be greater than  $V_{IN\ max}$ .

**Step 7:** Include a 0.01-µF, 50-V capacitor for  $C_{BOOST}$  in the design.

## 7.2.1.2.1 Capacitor Selection Guides

Table 7-1. Input and Output Capacitor Codes—Surface Mount

CAPACITOR REFERENCE CODE	SURFACE MOUNT								
	AVX TPS SERIES			SPRAGUE 594D SERIES			KEMET T495 SERIES		
	C (µF)	WV (V)	I <sub>rms</sub> (A)	C (µF)	WV (V)	I <sub>rms</sub> (A)	C (µF)	WV (V)	I <sub>rms</sub> (A)
C1	330	6.3	1.15	120	6.3	1.1	100	6.3	0.82
C2	100	10	1.1	220	6.3	1.4	220	6.3	1.1
C3	220	10	1.15	68	10	1.05	330	6.3	1.1
C4	47	16	0.89	150	10	1.35	100	10	1.1
C5	100	16	1.15	47	16	1	150	10	1.1
C6	33	20	0.77	100	16	1.3	220	10	1.1
C7	68	20	0.94	180	16	1.95	33	20	0.78
C8	22	25	0.77	47	20	1.15	47	20	0.94
C9	10	35	0.63	33	25	1.05	68	20	0.94
C10	22	35	0.66	68	25	1.6	10	35	0.63
C11	—	—	—	15	35	0.75	22	35	0.63
C12	—	—	—	33	35	1	4.7	50	0.66
C13	—	—	—	15	50	0.9	—	—	—

Table 7-2. Input and Output Capacitor Codes—Through Hole

CAPACITOR REFERENCE CODE	THROUGH HOLE											
	SANYO OS-CON SA SERIES			SANYO MV-GX SERIES			NICHICON PL SERIES			PANASONIC HFQ SERIES		
	C (µF)	WV (V)	I <sub>rms</sub> (A)	C (µF)	WV (V)	I <sub>rms</sub> (A)	C (µF)	WV (V)	I <sub>rms</sub> (A)	C (µF)	WV (V)	I <sub>rms</sub> (A)
C1	47	6.3	1	1000	6.3	0.8	680	10	0.8	82	35	0.4
C2	150	6.3	1.95	270	16	0.6	820	10	0.98	120	35	0.44
C3	330	6.3	2.45	470	16	0.75	1000	10	1.06	220	35	0.76
C4	100	10	1.87	560	16	0.95	1200	10	1.28	330	35	1.01
C5	220	10	2.36	820	16	1.25	2200	10	1.71	560	35	1.4
C6	33	16	0.96	1000	16	1.3	3300	10	2.18	820	35	1.62
C7	100	16	1.92	150	35	0.65	3900	10	2.36	1000	35	1.73
C8	150	16	2.28	470	35	1.3	6800	10	2.68	2200	35	2.8
C9	100	20	2.25	680	35	1.4	180	16	0.41	56	50	0.36
C10	47	25	2.09	1000	35	1.7	270	16	0.55	100	50	0.5
C11	—	—	—	220	63	0.76	470	16	0.77	220	50	0.92
C12	—	—	—	470	63	1.2	680	16	1.02	470	50	1.44
C13	—	—	—	680	63	1.5	820	16	1.22	560	50	1.68
C14	—	—	—	1000	63	1.75	1800	16	1.88	1200	50	2.22
C15	—	—	—	—	—	—	220	25	0.63	330	63	1.42
C16	—	—	—	—	—	—	220	35	0.79	1500	63	2.51
C17	—	—	—	—	—	—	560	35	1.43	—	—	—
C18	—	—	—	—	—	—	2200	35	2.68	—	—	—
C19	—	—	—	—	—	—	150	50	0.82	—	—	—
C20	—	—	—	—	—	—	220	50	1.04	—	—	—
C21	—	—	—	—	—	—	330	50	1.3	—	—	—
C22	—	—	—	—	—	—	100	63	0.75	—	—	—
C23	—	—	—	—	—	—	390	63	1.62	—	—	—
C24	—	—	—	—	—	—	820	63	2.22	—	—	—
C25	—	—	—	—	—	—	1200	63	2.51	—	—	—

### 7.2.1.2.2 Inductor Selection Guides

For Continuous Mode Operation

**Table 7-3. Inductor Manufacturer Part Numbers**

INDUCTOR REFERENCE NUMBER	INDUCTANCE (μH)	CURRENT (A)	RENCO		PULSE ENGINEERING		COILCRAFT
			THROUGH HOLE	SURFACE MOUNT	THROUGH HOLE	SURFACE MOUNT	SURFACE MOUNT
L23	33	1.35	RL-5471-7	RL1500-33	PE-53823	PE-53823S	DO3316-333
L24	22	1.65	RL-1283-22-43	RL1500-22	PE-53824	PE-53824S	DO3316-223
L25	15	2	RL-1283-15-43	RL1500-15	PE-53825	PE-53825S	DO3316-153
L29	100	1.41	RL-5471-4	RL-6050-100	PE-53829	PE-53829S	DO5022P-104
L30	68	1.71	RL-5471-5	RL6050-68	PE-53830	PE-53830S	DO5022P-683
L31	47	2.06	RL-5471-6	RL6050-47	PE-53831	PE-53831S	DO5022P-473
L32	33	2.46	RL-5471-7	RL6050-33	PE-53932	PE-53932S	DO5022P-333
L33	22	3.02	RL-1283-22-43	RL6050-22	PE-53933	PE-53933S	DO5022P-223
L34	15	3.65	RL-1283-15-43	—	PE-53934	PE-53934S	DO5022P-153
L38	68	2.97	RL-5472-2	—	PE-54038	PE-54038S	—
L39	47	3.57	RL-5472-3	—	PE-54039	PE-54039S	—
L40	33	4.26	RL-1283-33-43	—	PE-54040	PE-54040S	—
L41	22	5.22	RL-1283-22-43	—	PE-54041	P0841	—
L44	68	3.45	RL-5473-3	—	PE-54044	—	—
L45	10	4.47	RL-1283-10-43	—	—	P0845	DO5022P-103HC

**Table 7-4. Schottky Diode Selection Table**

REVERSE VOLTAGE (V)	SURFACE MOUNT		THROUGH HOLE	
	3 A	5 A OR MORE	3 A	5 A OR MORE
20	SK32	—	1N5820	—
			SR302	
30	SK33	MBRD835L	1N5821	—
	30WQ03F		31DQ03	
40	SK34	MBRB1545CT	1N5822	—
	30BQ040		MBR340	MBR745
	30WQ04F	6TQ045S	31DQ04	80SQ045
	MBRS340		SR403	6TQ045
	MBRD340			
50 or more	SK35	—	MBR350	—
	30WQ05F		31DQ05	
			SR305	

### 7.2.1.2.3 Custom Design with WEBENCH® Tools

[Click here](#) to create a custom design using the LM2670 devices with the WEBENCH Power Designer.

1. Start by entering the input voltage ( $V_{IN}$ ), output voltage ( $V_{OUT}$ ), and output current ( $I_{OUT}$ ) requirements.
2. Optimize the design for key parameters such as efficiency, footprint, and cost using the optimizer dial.
3. Compare the generated design with other possible solutions from Texas Instruments.

The WEBENCH Power Designer provides a customized schematic along with a list of materials with real-time pricing and component availability.

In most cases, these actions are available:

**LM2670**

SNVS036L – APRIL 2000 – REVISED JUNE 2025

- Run electrical simulations to see important waveforms and circuit performance
- Run thermal simulations to understand board thermal performance
- Export customized schematic and layout into popular CAD formats
- Print PDF reports for the design, and share the design with colleagues

 Get more information about WEBENCH tools at [www.ti.com/WEBENCH](http://www.ti.com/WEBENCH).

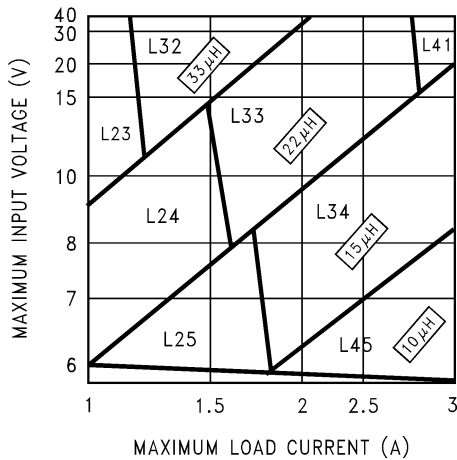
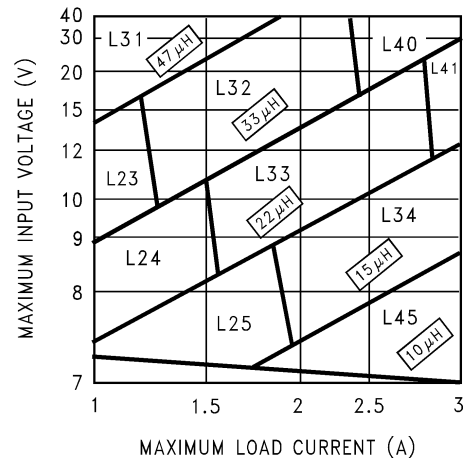
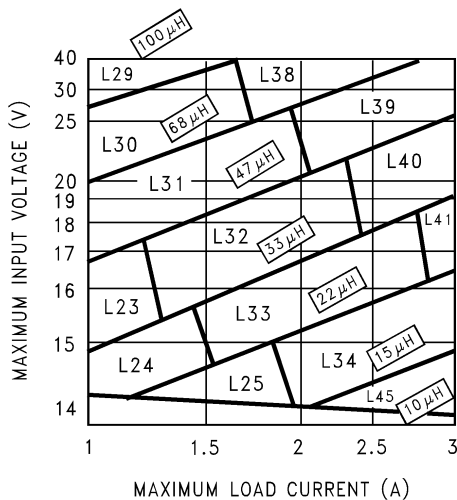
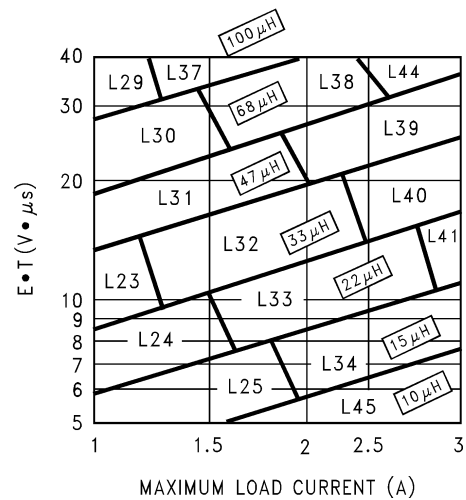
**7.2.1.3 Application Curves**

**Figure 7-2. LM2670 – 3.3 V**

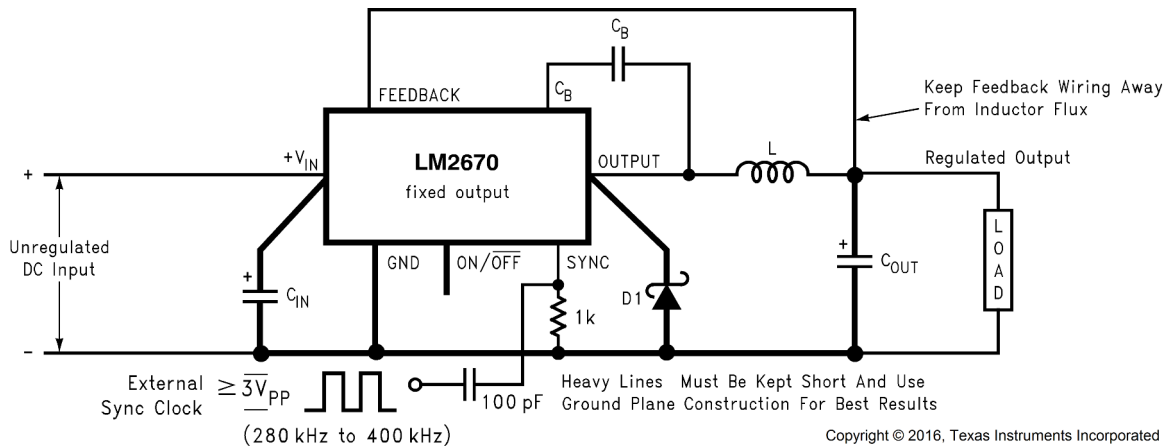
**Figure 7-3. LM2670 – 5 V**

**Figure 7-4. LM2670 – 12 V**

**Figure 7-5. LM2670 – Adjustable**

## 7.2.2 Fixed Output Voltage Application



**Figure 7-6. Basic Circuit for Fixed Output Voltage Applications**

### 7.2.2.1 Design Requirements

Select the power supply operating conditions and the maximum output current and follow below procedures to find the external components for LM2670

### 7.2.2.2 Detailed Design Procedure

A system logic power supply bus of 3.3 V is to be generated from a wall adapter which provides an unregulated DC voltage of 13 V to 16 V. The maximum load current is 2.5 A. Through-hole components are preferred.

**Step 1:** Operating conditions are:

- $V_{OUT} = 3.3\text{ V}$
- $V_{IN\text{ max}} = 16\text{ V}$
- $I_{LOAD\text{ max}} = 2.5\text{ A}$

**Step 2:** Select an LM2670T-3.3. The output voltage will have a tolerance of  $\pm 2\%$  at room temperature and  $\pm 3\%$  over the full operating temperature range.

**Step 3:** Use the nomograph for the 3.3-V device, [Figure 7-2](#). The intersection of the 16 V horizontal line ( $V_{IN\text{ max}}$ ) and the 2.5 A vertical line ( $I_{LOAD\text{ max}}$ ) indicates that L33, a 22- $\mu\text{H}$  inductor, is required.

From [Table 7-3](#), L33 in a through-hole component is available from Renco with part number RL-1283-22-43 or part number PE-53933 from Pulse Engineering.

**Step 4:** Use [Table 7-5](#) or [Table 7-6](#) to determine an output capacitor. With a 3.3-V output and a 22- $\mu\text{H}$  inductor there are four through-hole output capacitor solutions with the number of same type capacitors to be paralleled and an identifying capacitor code given. [Table 7-1](#) or [Table 7-2](#) provide the actual capacitor characteristics. Any of the following choices will work in the circuit:

- 1  $\times$  220- $\mu\text{F}$ , 10-V Sanyo OS-CON (code C5)
- 1  $\times$  1000- $\mu\text{F}$ , 35-V Sanyo MV-GX (code C10)
- 1  $\times$  2200- $\mu\text{F}$ , 10-V Nichicon PL (code C5)
- 1  $\times$  1000- $\mu\text{F}$ , 35-V Panasonic HFQ (code C7)

**Step 5:** Use [Table 7-7](#) or [Table 7-8](#) to select an input capacitor. With 3.3-V output and 22  $\mu\text{H}$  there are three through-hole solutions. These capacitors provide a sufficient voltage rating and an rms current rating greater than 1.25 A ( $1/2 I_{LOAD\text{ max}}$ ). Again using [Table 7-1](#) or [Table 7-2](#) for specific component characteristics the following choices are suitable:

- 1  $\times$  1000- $\mu\text{F}$ , 63-V Sanyo MV-GX (code C14)
- 1  $\times$  820- $\mu\text{F}$ , 63-V Nichicon PL (code C24)
- 1  $\times$  560- $\mu\text{F}$ , 50-V Panasonic HFQ (code C13)

**Step 6:** From [Table 7-4](#) a 3-A Schottky diode must be selected. For through-hole components 20-V rated diodes are sufficient, and 2 part types are suitable:

- 1N5820
- SR302

**Step 7:** A 0.01- $\mu$ F capacitor is used for  $C_{\text{BOOST}}$ .

#### 7.2.2.2.1 Capacitor Selection Guides

**Table 7-5. Output Capacitors for Fixed Output Voltage Application—Surface Mount**

OUTPUT VOLTAGE (V) <sup>(1) (2)</sup>	INDUCTANCE ( $\mu$ H)	SURFACE MOUNT					
		AVX TPS SERIES		SPRAGUE 594D SERIES		KEMET T495 SERIES	
		NO.	C CODE	NO.	C CODE	NO.	C CODE
3.3	10	4	C2	3	C1	4	C4
	15	4	C2	3	C1	4	C4
	22	3	C2	2	C7	3	C4
	33	2	C2	2	C6	2	C4
5	10	4	C2	4	C6	4	C4
	15	3	C2	2	C7	3	C4
	22	3	C2	2	C7	3	C4
	33	2	C2	2	C3	2	C4
	47	2	C2	1	C7	2	C4
12	10	4	C5	3	C6	5	C9
	15	3	C5	2	C7	4	C8
	22	2	C5	2	C6	3	C8
	33	2	C5	1	C7	2	C8
	47	2	C4	1	C6	2	C8
	68	1	C5	1	C5	2	C7
	100	1	C4	1	C5	1	C8

- (1) No. represents the number of identical capacitor types to be connected in parallel  
(2) C Code indicates the Capacitor Reference number in [Table 7-1](#) or [Table 7-2](#) for identifying the specific component from the manufacturer

**Table 7-6. Output Capacitors for Fixed Output Voltage Application—Through Hole**

OUTPUT VOLTAGE (V) <sup>(1) (2)</sup>	INDUCTANCE ( $\mu$ H)	THROUGH HOLE							
		SANYO OS-CON SA SERIES		SANYO MV-GX SERIES		NICHICON PL SERIES		PANASONIC HFQ SERIES	
		NO.	C CODE	NO.	C CODE	NO.	C CODE	NO.	C CODE
3.3	10	1	C3	1	C10	1	C6	2	C6
	15	1	C3	1	C10	1	C6	2	C5
	22	1	C5	1	C10	1	C5	1	C7
	33	1	C2	1	C10	1	C13	1	C5
5	10	2	C4	1	C10	1	C6	2	C5
	15	1	C5	1	C10	1	C5	1	C6
	22	1	C5	1	C5	1	C5	1	C5
	33	1	C4	1	C5	1	C13	1	C5
	47	1	C4	1	C4	1	C13	2	C3

**Table 7-6. Output Capacitors for Fixed Output Voltage Application—Through Hole (continued)**

OUTPUT VOLTAGE (V) (1) (2)	INDUCTANCE (μH)	THROUGH HOLE							
		SANYO OS-CON SA SERIES		SANYO MV-GX SERIES		NICHICON PL SERIES		PANASONIC HFQ SERIES	
		NO.	C CODE	NO.	C CODE	NO.	C CODE	NO.	C CODE
12	10	2	C7	1	C5	1	C18	2	C5
	15	1	C8	1	C5	1	C17	1	C5
	22	1	C7	1	C5	1	C13	1	C5
	33	1	C7	1	C3	1	C11	1	C4
	47	1	C7	1	C3	1	C10	1	C3
	68	1	C7	1	C2	1	C10	1	C3
	100	1	C7	1	C2	1	C9	1	C1

- (1) No. represents the number of identical capacitor types to be connected in parallel
- (2) C Code indicates the Capacitor Reference number in Table 7-1 or Table 7-2 for identifying the specific component from the manufacturer

**Table 7-7. Input Capacitors for Fixed Output Voltage Application—Surface Mount**

OUTPUT VOLTAGE (V) (1) (2) (3)	INDUCTANCE (μH)	SURFACE MOUNT					
		AVX TPS SERIES		SPRAGUE 594D SERIES		KEMET T495 SERIES	
		NO.	C CODE	NO.	C CODE	NO.	C CODE
3.3	10	2	C5	1	C7	2	C8
	15	3	C9	1	C10	3	C10
	22	See <sup>(4)</sup>	See <sup>(4)</sup>	2	C13	3	C12
	33	See <sup>(4)</sup>	See <sup>(4)</sup>	2	C13	2	C12
5	10	2	C5	1	C7	2	C8
	15	2	C5	1	C7	2	C8
	22	3	C10	2	C12	3	C11
	33	See <sup>(4)</sup>	See <sup>(4)</sup>	2	C13	3	C12
	47	See <sup>(4)</sup>	See <sup>(4)</sup>	1	C13	2	C12
12	10	2	C7	2	C10	2	C7
	15	2	C7	2	C10	2	C7
	22	3	C10	2	C12	3	C10
	33	3	C10	2	C12	3	C10
	47	See <sup>(4)</sup>	See <sup>(4)</sup>	2	C13	3	C12
	68	See <sup>(4)</sup>	See <sup>(4)</sup>	2	C13	2	C12
	100	See <sup>(4)</sup>	See <sup>(4)</sup>	1	C13	2	C12

- (1) Assumes worst case maximum input voltage and load current for a given inductance value
- (2) No. represents the number of identical capacitor types to be connected in parallel
- (3) C Code indicates the Capacitor Reference number in Table 7-1 or Table 7-2 for identifying the specific component from the manufacturer
- (4) Check voltage rating of capacitors to be greater than application input voltage

**Table 7-8. Input Capacitors for Fixed Output Voltage Application—Through Hole**

OUTPUT VOLTAGE (V) (1) (2) (3)	INDUCTANCE (μH)	THROUGH HOLE							
		SANYO OS-CON SA SERIES		SANYO MV-GX SERIES		NICHICON PL SERIES		PANASONIC HFQ SERIES	
		NO.	C CODE	NO.	C CODE	NO.	C CODE	NO.	C CODE
3.3	10	1	C7	2	C4	1	C5	1	C6
	15	1	C10	1	C10	1	C18	1	C6
	22	See <sup>(4)</sup>	See <sup>(4)</sup>	1	C14	1	C24	1	C13
	33	See <sup>(4)</sup>	See <sup>(4)</sup>	1	C12	1	C20	1	C12

**Table 7-8. Input Capacitors for Fixed Output Voltage Application—Through Hole (continued)**

OUTPUT VOLTAGE (V) (1) (2) (3)	INDUCTANCE (μH)	THROUGH HOLE							
		SANYO OS-CON SA SERIES		SANYO MV-GX SERIES		NICHICON PL SERIES		PANASONIC HFQ SERIES	
		NO.	C CODE	NO.	C CODE	NO.	C CODE	NO.	C CODE
5	10	1	C7	2	C4	1	C14	1	C6
	15	1	C7	2	C4	1	C14	1	C6
	22	See <sup>(4)</sup>	See <sup>(4)</sup>	1	C10	1	C18	1	C13
	33	See <sup>(4)</sup>	See <sup>(4)</sup>	1	C14	1	C23	1	C13
	47	See <sup>(4)</sup>	See <sup>(4)</sup>	1	C12	1	C20	1	C12
12	10	1	C9	1	C10	1	C18	1	C6
	15	1	C10	1	C10	1	C18	1	C6
	22	1	C10	1	C10	1	C18	1	C6
	33	See <sup>(4)</sup>	See <sup>(4)</sup>	1	C10	1	C18	1	C6
	47	See <sup>(4)</sup>	See <sup>(4)</sup>	1	C13	1	C23	1	C13
	68	See <sup>(4)</sup>	See <sup>(4)</sup>	1	C12	1	C21	1	C12
	100	See <sup>(4)</sup>	See <sup>(4)</sup>	1	C11	1	C22	1	C11

- (1) Assumes worst case maximum input voltage and load current for a given inductance value
- (2) No. represents the number of identical capacitor types to be connected in parallel
- (3) C Code indicates the Capacitor Reference number in [Table 7-1](#) or [Table 7-2](#) for identifying the specific component from the manufacturer
- (4) Check voltage rating of capacitors to be greater than application input voltage

### 7.2.3 Adjustable Output Voltage Application

Locate the Programming Resistors near the Feedback Pin Using Short Leads

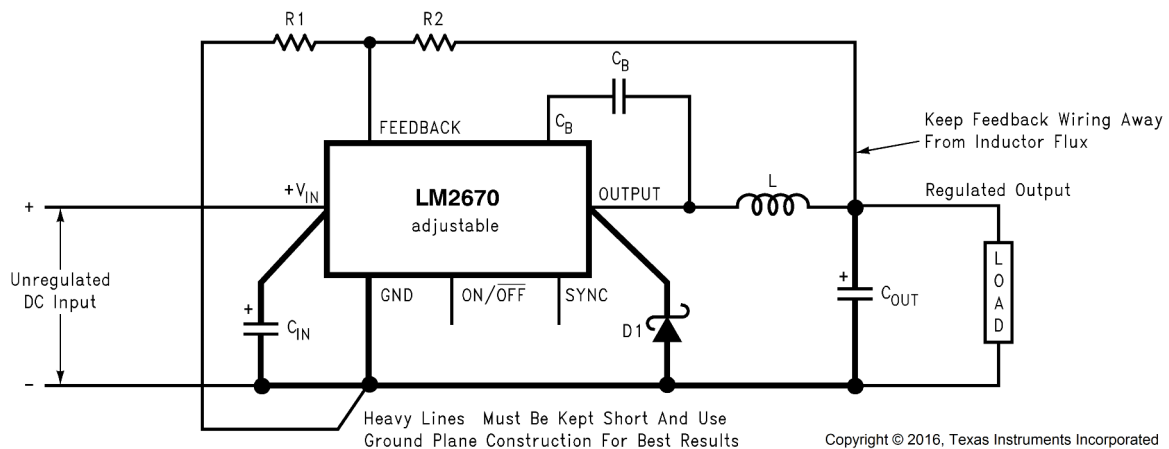
**Figure 7-7. Basic Circuit for Adjustable Output Voltage Applications**

#### 7.2.3.1 Design Requirements

Select the power supply operating conditions and the maximum output current and follow below procedures to find the external components for LM2670

#### 7.2.3.2 Detailed Design Procedure

In this example, it is desired to convert the voltage from a two battery automotive power supply (voltage range of 20 V to 28 V, typical in large truck applications) to the 14.8-VDC alternator supply typically used to power electronic equipment from single battery 12-V vehicle systems. The load current required is 2 A maximum. It is also desired to implement the power supply with all surface mount components.

**Step 1:** Operating conditions are:

- $V_{OUT} = 14.8\text{ V}$
- $V_{IN}$  maximum = 28 V
- $I_{LOAD}$  maximum = 2 A

**Step 2:** Select an LM2670S-ADJ. To set the output voltage to 14.9 V, two resistors need to be chosen (R1 and R2 in [Figure 7-7](#)). For the adjustable device the output voltage is set by the following relationship:

$$V_{OUT} = V_{FB} \left( 1 + \frac{R_2}{R_1} \right) \quad (1)$$

where

- $V_{FB}$  is the feedback voltage of typically 1.21 V

A recommended value to use for R1 is 1 k $\Omega$ . In this example then R2 is determined to be:

$$R_2 = R_1 \left( \frac{V_{OUT}}{V_{FB}} - 1 \right) = 1\text{ k}\Omega \left( \frac{14.8\text{ V}}{1.21\text{ V}} - 1 \right) \quad (2)$$

$$R_2 = 11.23\text{ k}\Omega$$

The closest standard 1% tolerance value to use is 11.3 k $\Omega$

This is set the nominal output voltage to 14.88 V which is within 0.5% of the target value.

**Step 3:** To use the nomograph for the adjustable device, [Figure 7-5](#), requires a calculation of the inductor Volt • microsecond constant ( $E \cdot T$  expressed in  $V \cdot \mu\text{S}$ ) from the following formula:

$$E \cdot T = (V_{IN(MAX)} - V_{OUT} - V_{SAT}) \cdot \frac{V_{OUT} + V_D}{V_{IN(MAX)} - V_{SAT} + V_D} \cdot \frac{1000}{260} (V \cdot \mu\text{s}) \quad (3)$$

where

- $V_{SAT}$  is the voltage drop across the internal power switch which is  $R_{ds(ON)}$  times  $I_{LOAD}$

In this example this can be typically  $0.15\ \Omega \times 2\text{ A}$  or 0.3 V and  $V_D$  is the voltage drop across the forward biased Schottky diode, typically 0.5 V. The switching frequency of 260 kHz is the nominal value to use to estimate the ON time of the switch during which energy is stored in the inductor.

For this example  $E \cdot T$  is found to be:

$$E \cdot T = (28 - 14.8 - 0.3) \cdot \frac{14.8 + 0.5}{28 - 0.3 + 0.5} \cdot \frac{1000}{260} (V \cdot \mu\text{s}) \quad (4)$$

$$E \cdot T = (12.9\text{ V}) \cdot \frac{15.3}{28.2} \cdot 3.85 (V \cdot \mu\text{s}) = 26.9 (V \cdot \mu\text{s}) \quad (5)$$

Using [Figure 7-5](#), the intersection of 27  $V \cdot \mu\text{S}$  horizontally and the 2 A vertical line ( $I_{LOAD}$  max) indicates that L38, a 68- $\mu\text{H}$  inductor, must be used.

From [Table 7-3](#), L38 in a surface mount component is available from Pulse Engineering with part number PE-54038S.

**Step 4:** Use [Table 7-9](#) or [Table 7-10](#) to determine an output capacitor. With a 14.8-V output the 12.5 to 15 V row is used and with a 68- $\mu\text{H}$  inductor there are three surface mount output capacitor solutions. [Table 7-1](#) or [Table 7-2](#) provides the actual capacitor characteristics based on the C Code number. Any of the following choices can be used:

- 1  $\times$  33- $\mu\text{F}$ , 20-V AVX TPS (code C6)
- 1  $\times$  47- $\mu\text{F}$ , 20-V Sprague 594 (code C8)

- 1 × 47- $\mu$ F, 20-V Kemet T495 (code C8)

---

**Note**

When using the adjustable device in low voltage applications (less than 3-V output), if the nomograph, [Figure 7-5](#), selects an inductance of 22  $\mu$ H or less, [Table 7-9](#) and [Table 7-10](#) do not provide an output capacitor solution. With these conditions the number of output capacitors required for stable operation becomes impractical. TI recommends using either a 33- $\mu$ H or 47- $\mu$ H inductor and the output capacitors from [Table 7-9](#) or [Table 7-10](#).

---

**Step 5:** An input capacitor for this example will require at least a 35-V WV rating with an RMS current rating of 1 A ( $1/2 I_{OUT\ max}$ ). From [Table 7-1](#) or [Table 7-2](#) it can be seen that C12, a 33- $\mu$ F, 35-V capacitor from Sprague, has the required voltage and current rating of the surface mount components.

**Step 6:** From [Table 7-4](#) a 3-A Schottky diode must be selected. For surface mount diodes with a margin of safety on the voltage rating one of five diodes can be used:

- SK34
- 30BQ040
- 30WQ04F
- MBRS340
- MBRD340

**Step 7:** A 0.01- $\mu$ F capacitor is used for  $C_{BOOST}$ .

**7.2.3.2.1 Capacitor Selection Guides**

**Table 7-9. Output Capacitors for Adjustable Output Voltage Applications—Surface Mount**

OUTPUT VOLTAGE (V) <sup>(1) (2)</sup>	INDUCTANCE (μH)	SURFACE MOUNT					
		AVX TPS SERIES		SPRAGUE 594D SERIES		KEMET T495 SERIES	
		NO.	C CODE	NO.	C CODE	NO.	C CODE
1.21 to 2.5	33 <sup>(3)</sup>	7	C1	6	C2	7	C3
	47 <sup>(3)</sup>	5	C1	4	C2	5	C3
2.5 to 3.75	33 <sup>(3)</sup>	4	C1	3	C2	4	C3
	47 <sup>(3)</sup>	3	C1	2	C2	3	C3
3.75 to 5	22	4	C1	3	C2	4	C3
	33	3	C1	2	C2	3	C3
	47	2	C1	2	C2	2	C3
5 to 6.25	22	3	C2	1	C3	3	C4
	33	2	C2	2	C3	2	C4
	47	2	C2	2	C3	2	C4
	68	1	C2	1	C3	1	C4
6.25 to 7.5	22	3	C2	1	C4	3	C4
	33	2	C2	1	C3	2	C4
	47	1	C3	1	C4	1	C6
	68	1	C2	1	C3	1	C4
7.5 to 10	33	2	C5	1	C6	2	C8
	47	1	C5	1	C6	2	C8
	68	1	C5	1	C6	1	C8
	100	1	C4	1	C5	1	C8
10 to 12.5	33	1	C5	1	C6	2	C8
	47	1	C5	1	C6	2	C8
	68	1	C5	1	C6	1	C8
	100	1	C5	1	C6	1	C8
12.5 to 15	33	1	C6	1	C8	1	C8
	47	1	C6	1	C8	1	C8
	68	1	C6	1	C8	1	C8
	100	1	C6	1	C8	1	C8
15 to 20	33	1	C8	1	C10	2	C10
	47	1	C8	1	C9	2	C10
	68	1	C8	1	C9	2	C10
	100	1	C8	1	C9	1	C10
20 to 30	33	2	C9	2	C11	2	C11
	47	1	C10	1	C12	1	C11
	68	1	C9	1	C12	1	C11
	100	1	C9	1	C12	1	C11
30 to 37	10	No Values Available		4	C13	8	C12
	15			3	C13	5	C12
	22			2	C13	4	C12
	33			1	C13	3	C12
	47			1	C13	2	C12
	68			1	C13	2	C12

- (1) No. represents the number of identical capacitor types to be connected in parallel
- (2) C Code indicates the Capacitor Reference number in [Table 7-1](#) or [Table 7-2](#) for identifying the specific component from the manufacturer
- (3) Set to a higher value for a practical design solution.

**Table 7-10. Output Capacitors for Adjustable Output Voltage Applications—Through Hole**

OUTPUT VOLTAGE (V) <sup>(1) (2)</sup>	INDUCTANCE ( $\mu$ H)	THROUGH HOLE							
		SANYO OS-CON SA SERIES		SANYO MV-GX SERIES		NICHICON PL SERIES		PANASONIC HFQ SERIES	
		NO.	C CODE	NO.	C CODE	NO.	C CODE	NO.	C CODE
1.21 to 2.5	33 <sup>(3)</sup>	2	C3	5	C1	5	C3	3	C
	47 <sup>(3)</sup>	2	C2	4	C1	3	C3	2	C5
2.5 to 3.75	33 <sup>(3)</sup>	1	C3	3	C1	3	C1	2	C5
	47 <sup>(3)</sup>	1	C2	2	C1	2	C3	1	C5
3.75 to 5	22	1	C3	3	C1	3	C1	2	C5
	33	1	C2	2	C1	2	C1	1	C5
	47	1	C2	2	C1	1	C3	1	C5
5 to 6.25	22	1	C5	2	C6	2	C3	2	C5
	33	1	C4	1	C6	2	C1	1	C5
	47	1	C4	1	C6	1	C3	1	C5
	68	1	C4	1	C6	1	C1	1	C5
6.25 to 7.5	22	1	C5	1	C6	2	C1	1	C5
	33	1	C4	1	C6	1	C3	1	C5
	47	1	C4	1	C6	1	C1	1	C5
	68	1	C4	1	C2	1	C1	1	C5
7.5 to 10	33	1	C7	1	C6	1	C14	1	C5
	47	1	C7	1	C6	1	C14	1	C5
	68	1	C7	1	C2	1	C14	1	C2
	100	1	C7	1	C2	1	C14	1	C2
10 to 12.5	33	1	C7	1	C6	1	C14	1	C5
	47	1	C7	1	C2	1	C14	1	C5
	68	1	C7	1	C2	1	C9	1	C2
	100	1	C7	1	C2	1	C9	1	C2
12.5 to 15	33	1	C9	1	C10	1	C15	1	C2
	47	1	C9	1	C10	1	C15	1	C2
	68	1	C9	1	C10	1	C15	1	C2
	100	1	C9	1	C10	1	C15	1	C2
15 to 20	33	1	C10	1	C7	1	C15	1	C2
	47	1	C10	1	C7	1	C15	1	C2
	68	1	C10	1	C7	1	C15	1	C2
	100	1	C10	1	C7	1	C15	1	C2
20 to 30	33	No Values Available		1	C7	1	C16	1	C2
	47			1	C7	1	C16	1	C2
	68			1	C7	1	C16	1	C2
	100			1	C7	1	C16	1	C2
30 to 37	10	No Values Available		1	C12	1	C20	1	C10
	15			1	C11	1	C20	1	C11
	22			1	C11	1	C20	1	C10
	33			1	C11	1	C20	1	C10
	47			1	C11	1	C20	1	C10
	68			1	C11	1	C20	1	C10

- (1) No. represents the number of identical capacitor types to be connected in parallel  
(2) C Code indicates the Capacitor Reference number in [Table 7-1](#) or [Table 7-2](#) for identifying the specific component from the manufacturer  
(3) Set to a higher value for a practical design solution.

### 7.3 Power Supply Recommendations

The LM2670 is designed to operate from an input voltage supply up to 40 V. This input supply must be well regulated and able to withstand maximum input current and maintain a stable voltage.

### 7.4 Layout

#### 7.4.1 Layout Guidelines

Board layout is critical for the proper operation of switching power supplies. First, the ground plane area must be sufficient for thermal dissipation purposes. Second, appropriate guidelines must be followed to reduce the effects of switching noise. Switch mode converters are very fast switching devices. In such cases, the rapid increase of input current combined with the parasitic trace inductance generates unwanted  $L di/dt$  noise spikes. The magnitude of this noise tends to increase as the output current increases. This noise can turn into electromagnetic interference (EMI) and can also cause problems in device performance. Therefore, take care in layout to minimize the effect of this switching noise. The most important layout rule is to keep the AC current loops as small as possible. [Figure 7-8](#) shows the current flow in a buck converter. The top schematic shows a dotted line which represents the current flow during the top switch ON-state. The middle schematic shows the current flow during the top switch OFF-state. The bottom schematic shows the currents referred to as ac currents. These AC currents are the most critical because they are changing in a very short time period. The dotted lines of the bottom schematic are the traces to keep as short and wide as possible. This also yields a small loop area reducing the loop inductance. To avoid functional problems due to layout, review the PCB layout example. Best results are achieved if the placement of the LM2679 device, the bypass capacitor, the Schottky diode, RFBB, RFBT, and the inductor are placed as shown in the example. Note that, in the layout shown, R1 = RFBB and R2 = RFBT. TI also recommends using 2-oz. copper boards or heavier to help thermal dissipation and to reduce the parasitic inductances of board traces. See application note [AN-1229 SIMPLE SWITCHER® PCB Layout Guidelines](#) for more information.

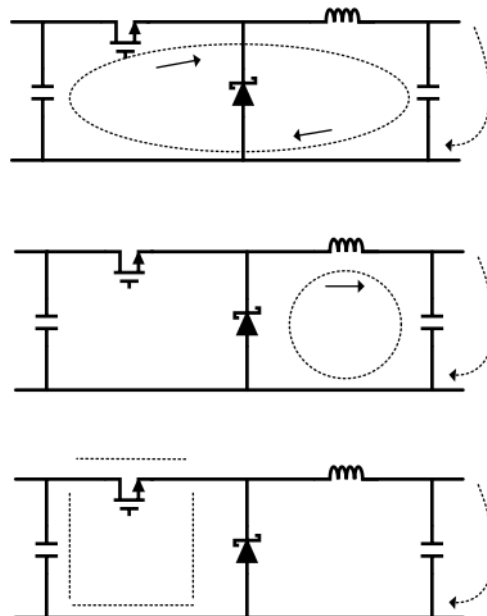

**Figure 7-8. Typical Current Flow on a Buck Converter**

### 7.4.2 Layout Example

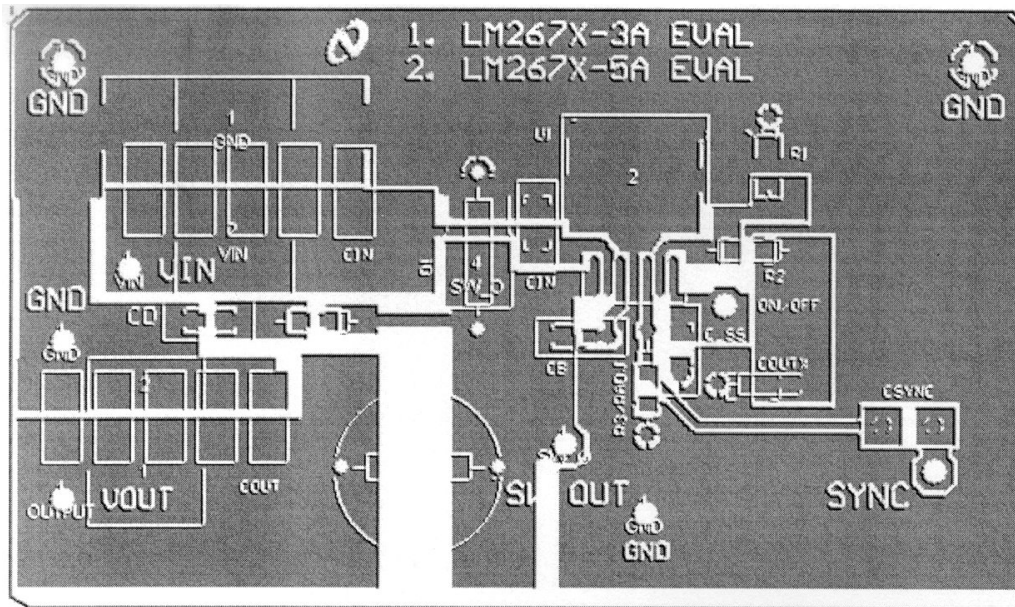

Figure 7-9. Top Layer Foil Pattern of Printed-Circuit Board

## 8 Device and Documentation Support

### 8.1 Device Support

#### 8.1.1 Third-Party Products Disclaimer

TI'S PUBLICATION OF INFORMATION REGARDING THIRD-PARTY PRODUCTS OR SERVICES DOES NOT CONSTITUTE AN ENDORSEMENT REGARDING THE SUITABILITY OF SUCH PRODUCTS OR SERVICES OR A WARRANTY, REPRESENTATION OR ENDORSEMENT OF SUCH PRODUCTS OR SERVICES, EITHER ALONE OR IN COMBINATION WITH ANY TI PRODUCT OR SERVICE.

#### 8.1.2 Development Support

For development support see the following:

- For TI's WEBENCH Design Environment, visit the [WEBENCH Design Center](#)

##### 8.1.2.1 Custom Design with WEBENCH® Tools

[Click here](#) to create a custom design using the LM2670 devices with the WEBENCH Power Designer.

1. Start by entering the input voltage ( $V_{IN}$ ), output voltage ( $V_{OUT}$ ), and output current ( $I_{OUT}$ ) requirements.
2. Optimize the design for key parameters such as efficiency, footprint, and cost using the optimizer dial.
3. Compare the generated design with other possible solutions from Texas Instruments.

The WEBENCH Power Designer provides a customized schematic along with a list of materials with real-time pricing and component availability.

In most cases, these actions are available:

- Run electrical simulations to see important waveforms and circuit performance
- Run thermal simulations to understand board thermal performance
- Export customized schematic and layout into popular CAD formats
- Print PDF reports for the design, and share the design with colleagues

Get more information about WEBENCH tools at [www.ti.com/WEBENCH](http://www.ti.com/WEBENCH).

### 8.2 Documentation Support

#### 8.2.1 Related Documentation

For related documentation, see the following:

- Texas Instruments, [AN-1187 Leadless Leadframe Package \(LLP\) application note](#)
- Texas Instruments, [AN-1229 SIMPLE SWITCHER® PCB Layout Guidelines application note](#)

### 8.3 Receiving Notification of Documentation Updates

To receive notification of documentation updates, navigate to the device product folder on [ti.com](http://ti.com). Click on *Notifications* to register and receive a weekly digest of any product information that has changed. For change details, review the revision history included in any revised document.

### 8.4 Support Resources

[TI E2E™ support forums](#) are an engineer's go-to source for fast, verified answers and design help — straight from the experts. Search existing answers or ask your own question to get the quick design help you need.

Linked content is provided "AS IS" by the respective contributors. They do not constitute TI specifications and do not necessarily reflect TI's views; see TI's [Terms of Use](#).

### 8.5 Trademarks

TI E2E™ is a trademark of Texas Instruments.

SIMPLE SWITCHER® and WEBENCH® are registered trademarks of Texas Instruments.

All trademarks are the property of their respective owners.

## 8.6 Electrostatic Discharge Caution



This integrated circuit can be damaged by ESD. Texas Instruments recommends that all integrated circuits be handled with appropriate precautions. Failure to observe proper handling and installation procedures can cause damage.

ESD damage can range from subtle performance degradation to complete device failure. Precision integrated circuits may be more susceptible to damage because very small parametric changes could cause the device not to meet its published specifications.

## 8.7 Glossary

### [TI Glossary](#)

This glossary lists and explains terms, acronyms, and definitions.

## 9 Revision History

NOTE: Page numbers for previous revisions may differ from page numbers in the current version.

<b>Changes from Revision K (June 2016) to Revision L (June 2025)</b>	<b>Page</b>
• Updated the numbering format for tables, figures, and cross-references throughout the document.....	1
• Added information relating to WEBENCH.....	1
• Added approved noun following the SIMPLE SWITCHER trademark throughout the document.....	1
• Added information surrounding proper DAP connection.....	3
• Updated the device name listed in the <i>Thermal Information</i> table to LM2670.....	5
• Changed listed test condition parameter from 5A to 3A.....	5
• Deleted RADJ specification.....	5
• Changed listed test condition parameter from 5A to 3A.....	5
• Changed listed test condition parameter from 5A to 3A.....	6
• Added <i>Electrical Characteristics table</i> for ADJ variant.....	6
• Changed lswitch test condition parameter from 5A to 3A.....	6
• Added information relating to WEBENCH.....	14
• Added information relating to WEBENCH.....	19
• Added information relating to WEBENCH.....	31

---

<b>Changes from Revision J (April 2013) to Revision K (June 2016)</b>	<b>Page</b>
• Added <i>ESD Ratings table, Feature Description section, Device Functional Modes, Application and Implementation section, Power Supply Recommendations section, Layout section, Device and Documentation Support section, and Mechanical, Packaging, and Orderable Information section</i> .....	1
• Removed all references to Computer Design Software <b>LM267X Made Simple</b> (Version 6.0).....	1

---

## 10 Mechanical, Packaging, and Orderable Information

The following pages include mechanical, packaging, and orderable information. This information is the most current data available for the designated devices. This data is subject to change without notice and revision of this document. For browser-based versions of this data sheet, refer to the left-hand navigation.

### 10.1 DAP (VSON Package)

The Die Attach Pad (DAP) can and must be connected to PCB Ground plane or island. For CAD and assembly guidelines see [Application Note AN-1187](http://www.ti.com/lscs/ti/analog/powermanagement/power_portal.page) at [www.ti.com/lscs/ti/analog/powermanagement/power\\_portal.page](http://www.ti.com/lscs/ti/analog/powermanagement/power_portal.page).

**PACKAGING INFORMATION**

Orderable part number	Status (1)	Material type (2)	Package   Pins	Package qty   Carrier	RoHS (3)	Lead finish/ Ball material (4)	MSL rating/ Peak reflow (5)	Op temp (°C)	Part marking (6)
<a href="#">LM2670S-12/NOPB</a>	Active	Production	DDPAK/TO-263 (KTW)   7	45   TUBE	ROHS Exempt	SN	Level-3-245C-168 HR	-40 to 125	LM2670 S-12
LM2670S-12/NOPB.B	Active	Production	DDPAK/TO-263 (KTW)   7	45   TUBE	ROHS Exempt	SN	Level-3-245C-168 HR	-40 to 125	LM2670 S-12
<a href="#">LM2670S-3.3/NOPB</a>	Active	Production	DDPAK/TO-263 (KTW)   7	45   TUBE	ROHS Exempt	SN	Level-3-245C-168 HR	-40 to 125	LM2670 S-3.3
LM2670S-3.3/NOPB.B	Active	Production	DDPAK/TO-263 (KTW)   7	45   TUBE	ROHS Exempt	SN	Level-3-245C-168 HR	-40 to 125	LM2670 S-3.3
<a href="#">LM2670S-5.0/NOPB</a>	Active	Production	DDPAK/TO-263 (KTW)   7	45   TUBE	ROHS Exempt	SN	Level-3-245C-168 HR	-40 to 125	LM2670 S-5.0
LM2670S-5.0/NOPB.B	Active	Production	DDPAK/TO-263 (KTW)   7	45   TUBE	ROHS Exempt	SN	Level-3-245C-168 HR	-40 to 125	LM2670 S-5.0
<a href="#">LM2670S-ADJ/NOPB</a>	Active	Production	DDPAK/TO-263 (KTW)   7	45   TUBE	ROHS Exempt	SN	Level-3-245C-168 HR	-40 to 125	LM2670 S-ADJ
LM2670S-ADJ/NOPB.B	Active	Production	DDPAK/TO-263 (KTW)   7	45   TUBE	ROHS Exempt	SN	Level-3-245C-168 HR	-40 to 125	LM2670 S-ADJ
<a href="#">LM2670SD-12/NOPB</a>	Active	Production	VSON (NHM)   14	250   SMALL T&R	Yes	SN	Level-1-260C-UNLIM	-40 to 125	S0002LB
LM2670SD-12/NOPB.B	Active	Production	VSON (NHM)   14	250   SMALL T&R	Yes	SN	Level-1-260C-UNLIM	-40 to 125	S0002LB
<a href="#">LM2670SD-3.3/NOPB</a>	Active	Production	VSON (NHM)   14	250   SMALL T&R	Yes	SN	Level-1-260C-UNLIM	-40 to 125	S0002NB
LM2670SD-3.3/NOPB.B	Active	Production	VSON (NHM)   14	250   SMALL T&R	Yes	SN	Level-1-260C-UNLIM	-40 to 125	S0002NB
<a href="#">LM2670SD-5.0/NOPB</a>	Active	Production	VSON (NHM)   14	250   SMALL T&R	Yes	SN	Level-1-260C-UNLIM	-40 to 125	S0002PB
LM2670SD-5.0/NOPB.B	Active	Production	VSON (NHM)   14	250   SMALL T&R	Yes	SN	Level-1-260C-UNLIM	-40 to 125	S0002PB
<a href="#">LM2670SD-ADJ/NOPB</a>	Active	Production	VSON (NHM)   14	250   SMALL T&R	Yes	SN	Level-1-260C-UNLIM	-40 to 125	S0002RB
LM2670SD-ADJ/NOPB.B	Active	Production	VSON (NHM)   14	250   SMALL T&R	Yes	SN	Level-1-260C-UNLIM	-40 to 125	S0002RB
<a href="#">LM2670SDX-3.3/NOPB</a>	Active	Production	VSON (NHM)   14	2500   LARGE T&R	Yes	SN	Level-1-260C-UNLIM	-40 to 125	S0002NB
LM2670SDX-3.3/NOPB.B	Active	Production	VSON (NHM)   14	2500   LARGE T&R	Yes	SN	Level-1-260C-UNLIM	-40 to 125	S0002NB
<a href="#">LM2670SDX-5.0/NOPB</a>	Active	Production	VSON (NHM)   14	2500   LARGE T&R	Yes	SN	Level-1-260C-UNLIM	-40 to 125	S0002PB
LM2670SDX-5.0/NOPB.B	Active	Production	VSON (NHM)   14	2500   LARGE T&R	Yes	SN	Level-1-260C-UNLIM	-40 to 125	S0002PB
<a href="#">LM2670SDX-ADJ/NOPB</a>	Active	Production	VSON (NHM)   14	2500   LARGE T&R	Yes	SN	Level-1-260C-UNLIM	-40 to 125	S0002RB
LM2670SDX-ADJ/NOPB.B	Active	Production	VSON (NHM)   14	2500   LARGE T&R	Yes	SN	Level-1-260C-UNLIM	-40 to 125	S0002RB

Orderable part number	Status (1)	Material type (2)	Package   Pins	Package qty   Carrier	RoHS (3)	Lead finish/ Ball material (4)	MSL rating/ Peak reflow (5)	Op temp (°C)	Part marking (6)
<a href="#">LM2670SX-12/NOPB</a>	Active	Production	DDPAK/TO-263 (KTW)   7	500   LARGE T&R	ROHS Exempt	SN	Level-3-245C-168 HR	-40 to 125	LM2670 S-12
LM2670SX-12/NOPB.B	Active	Production	DDPAK/TO-263 (KTW)   7	500   LARGE T&R	ROHS Exempt	SN	Level-3-245C-168 HR	-40 to 125	LM2670 S-12
<a href="#">LM2670SX-3.3/NOPB</a>	Active	Production	DDPAK/TO-263 (KTW)   7	500   LARGE T&R	ROHS Exempt	SN	Level-3-245C-168 HR	-40 to 125	LM2670 S-3.3
LM2670SX-3.3/NOPB.B	Active	Production	DDPAK/TO-263 (KTW)   7	500   LARGE T&R	ROHS Exempt	SN	Level-3-245C-168 HR	-40 to 125	LM2670 S-3.3
<a href="#">LM2670SX-5.0/NOPB</a>	Active	Production	DDPAK/TO-263 (KTW)   7	500   LARGE T&R	ROHS Exempt	SN	Level-3-245C-168 HR	-40 to 125	LM2670 S-5.0
LM2670SX-5.0/NOPB.B	Active	Production	DDPAK/TO-263 (KTW)   7	500   LARGE T&R	ROHS Exempt	SN	Level-3-245C-168 HR	-40 to 125	LM2670 S-5.0
<a href="#">LM2670SX-ADJ/NOPB</a>	Active	Production	DDPAK/TO-263 (KTW)   7	500   LARGE T&R	ROHS Exempt	SN	Level-3-245C-168 HR	-40 to 125	LM2670 S-ADJ
LM2670SX-ADJ/NOPB.B	Active	Production	DDPAK/TO-263 (KTW)   7	500   LARGE T&R	ROHS Exempt	SN	Level-3-245C-168 HR	-40 to 125	LM2670 S-ADJ
<a href="#">LM2670T-12/NOPB</a>	Active	Production	TO-220 (NDZ)   7	45   TUBE	Yes	SN	Level-1-NA-UNLIM	-40 to 125	LM2670 T-12
LM2670T-12/NOPB.B	Active	Production	TO-220 (NDZ)   7	45   TUBE	Yes	SN	Level-1-NA-UNLIM	-40 to 125	LM2670 T-12
<a href="#">LM2670T-3.3/NOPB</a>	Active	Production	TO-220 (NDZ)   7	45   TUBE	Yes	SN	Level-1-NA-UNLIM	-40 to 125	LM2670 T-3.3
LM2670T-3.3/NOPB.B	Active	Production	TO-220 (NDZ)   7	45   TUBE	Yes	SN	Level-1-NA-UNLIM	-40 to 125	LM2670 T-3.3
<a href="#">LM2670T-5.0/NOPB</a>	Active	Production	TO-220 (NDZ)   7	45   TUBE	Yes	SN	Level-1-NA-UNLIM	-40 to 125	LM2670 T-5.0
LM2670T-5.0/NOPB.B	Active	Production	TO-220 (NDZ)   7	45   TUBE	Yes	SN	Level-1-NA-UNLIM	-40 to 125	LM2670 T-5.0
<a href="#">LM2670T-ADJ/NOPB</a>	Active	Production	TO-220 (NDZ)   7	45   TUBE	Yes	SN	Level-1-NA-UNLIM	-40 to 125	LM2670 T-ADJ
LM2670T-ADJ/NOPB.B	Active	Production	TO-220 (NDZ)   7	45   TUBE	Yes	SN	Level-1-NA-UNLIM	-40 to 125	LM2670 T-ADJ

<sup>(1)</sup> **Status:** For more details on status, see our [product life cycle](#).

- (2) **Material type:** When designated, preproduction parts are prototypes/experimental devices, and are not yet approved or released for full production. Testing and final process, including without limitation quality assurance, reliability performance testing, and/or process qualification, may not yet be complete, and this item is subject to further changes or possible discontinuation. If available for ordering, purchases will be subject to an additional waiver at checkout, and are intended for early internal evaluation purposes only. These items are sold without warranties of any kind.
- (3) **RoHS values:** Yes, No, RoHS Exempt. See the [TI RoHS Statement](#) for additional information and value definition.
- (4) **Lead finish/Ball material:** Parts may have multiple material finish options. Finish options are separated by a vertical ruled line. Lead finish/Ball material values may wrap to two lines if the finish value exceeds the maximum column width.
- (5) **MSL rating/Peak reflow:** The moisture sensitivity level ratings and peak solder (reflow) temperatures. In the event that a part has multiple moisture sensitivity ratings, only the lowest level per JEDEC standards is shown. Refer to the shipping label for the actual reflow temperature that will be used to mount the part to the printed circuit board.
- (6) **Part marking:** There may be an additional marking, which relates to the logo, the lot trace code information, or the environmental category of the part.

Multiple part markings will be inside parentheses. Only one part marking contained in parentheses and separated by a "~" will appear on a part. If a line is indented then it is a continuation of the previous line and the two combined represent the entire part marking for that device.

**Important Information and Disclaimer:** The information provided on this page represents TI's knowledge and belief as of the date that it is provided. TI bases its knowledge and belief on information provided by third parties, and makes no representation or warranty as to the accuracy of such information. Efforts are underway to better integrate information from third parties. TI has taken and continues to take reasonable steps to provide representative and accurate information but may not have conducted destructive testing or chemical analysis on incoming materials and chemicals. TI and TI suppliers consider certain information to be proprietary, and thus CAS numbers and other limited information may not be available for release.

In no event shall TI's liability arising out of such information exceed the total purchase price of the TI part(s) at issue in this document sold by TI to Customer on an annual basis.

**TAPE AND REEL INFORMATION**

**QUADRANT ASSIGNMENTS FOR PIN 1 ORIENTATION IN TAPE**



\*All dimensions are nominal

Device	Package Type	Package Drawing	Pins	SPQ	Reel Diameter (mm)	Reel Width W1 (mm)	A0 (mm)	B0 (mm)	K0 (mm)	P1 (mm)	W (mm)	Pin1 Quadrant
LM2670SD-12/NOPB	VSON	NHM	14	250	178.0	16.4	5.3	6.3	1.5	12.0	16.0	Q1
LM2670SD-3.3/NOPB	VSON	NHM	14	250	178.0	16.4	5.3	6.3	1.5	12.0	16.0	Q1
LM2670SD-5.0/NOPB	VSON	NHM	14	250	178.0	16.4	5.3	6.3	1.5	12.0	16.0	Q1
LM2670SD-ADJ/NOPB	VSON	NHM	14	250	178.0	16.4	5.3	6.3	1.5	12.0	16.0	Q1
LM2670SDX-3.3/NOPB	VSON	NHM	14	2500	330.0	16.4	5.3	6.3	1.5	12.0	16.0	Q1
LM2670SDX-5.0/NOPB	VSON	NHM	14	2500	330.0	16.4	5.3	6.3	1.5	12.0	16.0	Q1
LM2670SDX-ADJ/NOPB	VSON	NHM	14	2500	330.0	16.4	5.3	6.3	1.5	12.0	16.0	Q1
LM2670SX-12/NOPB	DDPAK/ TO-263	KTW	7	500	330.0	24.4	10.75	14.85	5.0	16.0	24.0	Q2
LM2670SX-3.3/NOPB	DDPAK/ TO-263	KTW	7	500	330.0	24.4	10.75	14.85	5.0	16.0	24.0	Q2
LM2670SX-5.0/NOPB	DDPAK/ TO-263	KTW	7	500	330.0	24.4	10.75	14.85	5.0	16.0	24.0	Q2
LM2670SX-ADJ/NOPB	DDPAK/ TO-263	KTW	7	500	330.0	24.4	10.75	14.85	5.0	16.0	24.0	Q2

**TAPE AND REEL BOX DIMENSIONS**

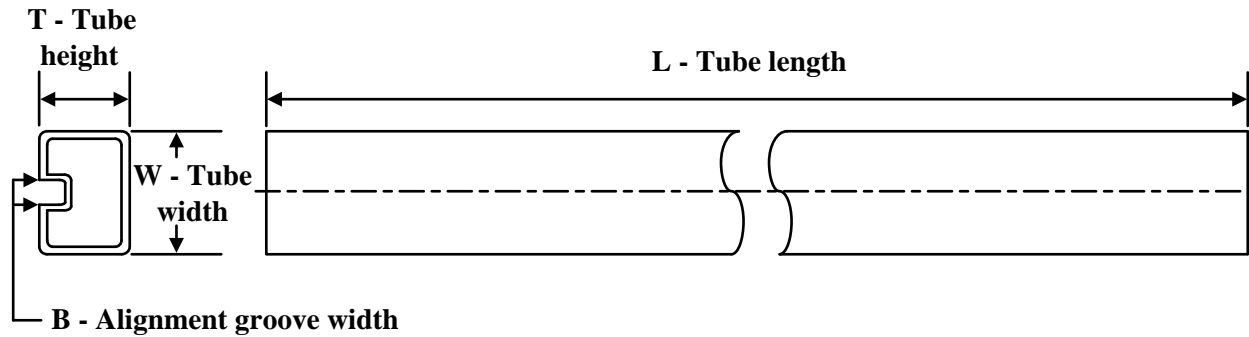

\*All dimensions are nominal

Device	Package Type	Package Drawing	Pins	SPQ	Length (mm)	Width (mm)	Height (mm)
LM2670SD-12/NOPB	VSON	NHM	14	250	210.0	185.0	35.0
LM2670SD-3.3/NOPB	VSON	NHM	14	250	210.0	185.0	35.0
LM2670SD-5.0/NOPB	VSON	NHM	14	250	210.0	185.0	35.0
LM2670SD-ADJ/NOPB	VSON	NHM	14	250	210.0	185.0	35.0
LM2670SDX-3.3/NOPB	VSON	NHM	14	2500	367.0	367.0	35.0
LM2670SDX-5.0/NOPB	VSON	NHM	14	2500	367.0	367.0	35.0
LM2670SDX-ADJ/NOPB	VSON	NHM	14	2500	367.0	367.0	35.0
LM2670SX-12/NOPB	DDPAK/TO-263	KTW	7	500	356.0	356.0	45.0
LM2670SX-3.3/NOPB	DDPAK/TO-263	KTW	7	500	356.0	356.0	45.0
LM2670SX-5.0/NOPB	DDPAK/TO-263	KTW	7	500	356.0	356.0	45.0
LM2670SX-ADJ/NOPB	DDPAK/TO-263	KTW	7	500	356.0	356.0	45.0

**TUBE**

\*All dimensions are nominal

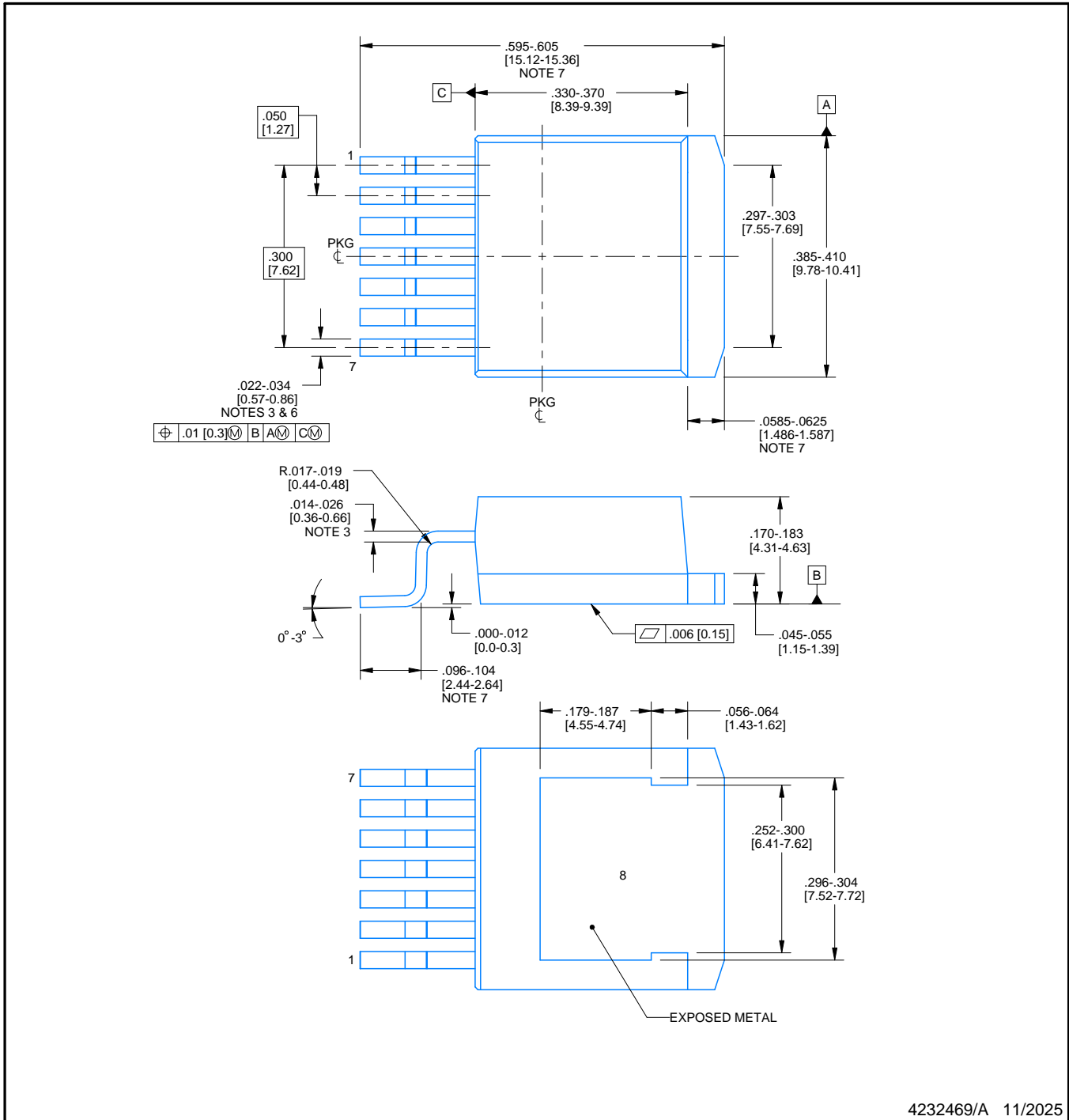
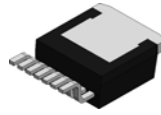
Device	Package Name	Package Type	Pins	SPQ	L (mm)	W (mm)	T (μm)	B (mm)
LM2670S-12/NOPB	KTW	TO-263	7	45	502	25	8204.2	9.19
LM2670S-12/NOPB.B	KTW	TO-263	7	45	502	25	8204.2	9.19
LM2670S-3.3/NOPB	KTW	TO-263	7	45	502	25	8204.2	9.19
LM2670S-3.3/NOPB.B	KTW	TO-263	7	45	502	25	8204.2	9.19
LM2670S-5.0/NOPB	KTW	TO-263	7	45	502	25	8204.2	9.19
LM2670S-5.0/NOPB.B	KTW	TO-263	7	45	502	25	8204.2	9.19
LM2670S-ADJ/NOPB	KTW	TO-263	7	45	502	25	8204.2	9.19
LM2670S-ADJ/NOPB.B	KTW	TO-263	7	45	502	25	8204.2	9.19
LM2670T-12/NOPB	NDZ	TO-220	7	45	502	30	30048.2	10.74
LM2670T-12/NOPB.B	NDZ	TO-220	7	45	502	30	30048.2	10.74
LM2670T-3.3/NOPB	NDZ	TO-220	7	45	502	30	30048.2	10.74
LM2670T-3.3/NOPB.B	NDZ	TO-220	7	45	502	30	30048.2	10.74
LM2670T-5.0/NOPB	NDZ	TO-220	7	45	502	30	30048.2	10.74
LM2670T-5.0/NOPB.B	NDZ	TO-220	7	45	502	30	30048.2	10.74
LM2670T-ADJ/NOPB	NDZ	TO-220	7	45	502	30	30048.2	10.74
LM2670T-ADJ/NOPB.B	NDZ	TO-220	7	45	502	30	30048.2	10.74



4232469/A 11/2025

NOTES:

1. All linear dimensions are in inches [millimeters]. Any dimensions in parenthesis are for reference only. Dimensioning and tolerancing per ASME Y14.5M.
2. This drawing is subject to change without notice.
3. Lead width and height dimensions apply to the plated lead.
4. Leads are not allowed above the Datum B.
5. Stand-off height is measured from lead tip with reference to Datum B.
6. Lead width dimension does not include dambar protrusion. Allowable dambar protrusion shall not cause the lead width to exceed the maximum width dimension by more than 0.003".
7. Falls within JEDEC MO-169 with the exception of the dimensions indicated.

# EXAMPLE BOARD LAYOUT

KTW0007A

TO-263 - 5 mm max height

TRANSISTOR OUTLINE

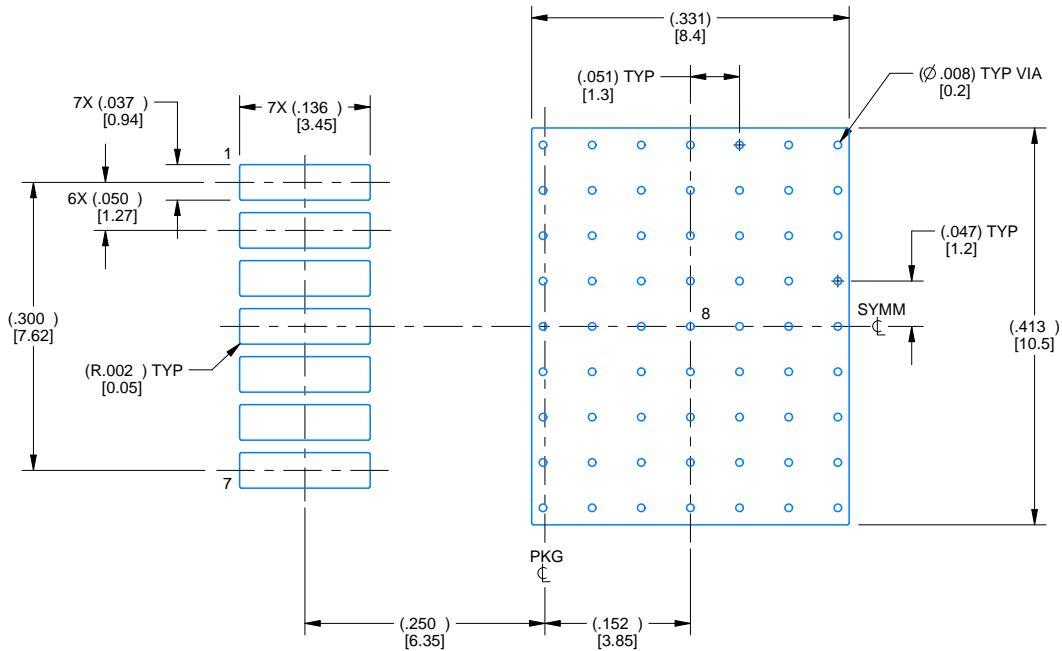

LAND PATTERN EXAMPLE  
EXPOSED METAL SHOWN  
SCALE: 5X

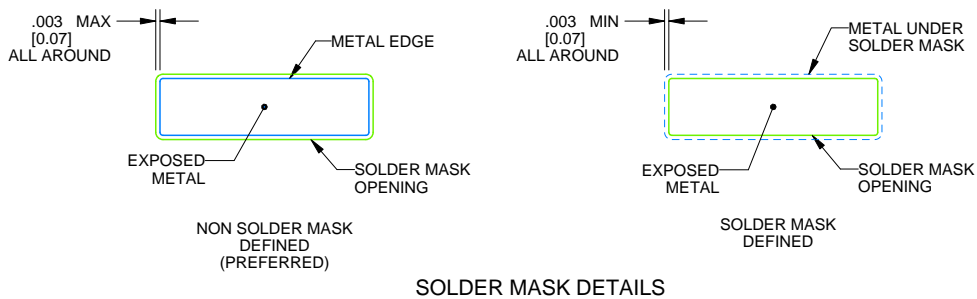

SOLDER MASK DETAILS

4232469/A 11/2025

NOTES: (continued)

8. This package is designed to be soldered to a thermal pad on the board. For more information, see Texas Instruments literature numbers SLMA002([www.ti.com/lit/slm002](http://www.ti.com/lit/slm002)) and SLMA004 ([www.ti.com/lit/slma004](http://www.ti.com/lit/slma004)).
9. Vias are optional depending on application, refer to device data sheet. It is recommended that vias under paste be filled, plugged or tented.

# EXAMPLE STENCIL DESIGN

KTW0007A

TO-263 - 5 mm max height

TRANSISTOR OUTLINE

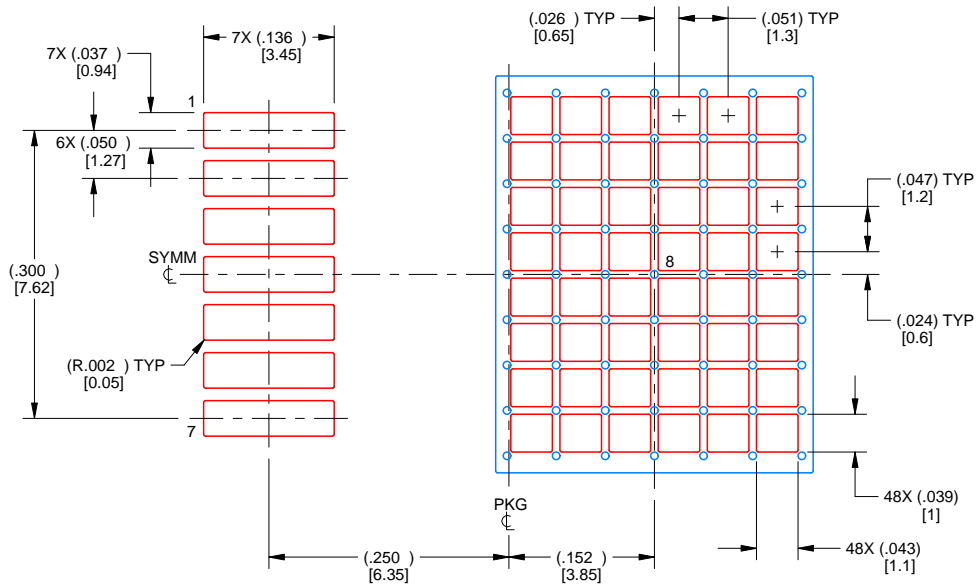

SOLDER PASTE EXAMPLE  
 BASED ON 0.125 mm THICK STENCIL  
 SCALE: 5X

PRINTED SOLDER COVERAGE BY AREA UNDER PACKAGE  
 PAD 8: 60%

4232469/A 11/2025

NOTES: (continued)

10. Laser cutting apertures with trapezoidal walls and rounded corners may offer better paste release. IPC-7525 may have alternate design recommendations.
11. Board assembly site may have different recommendations for stencil design.

NHM0014A

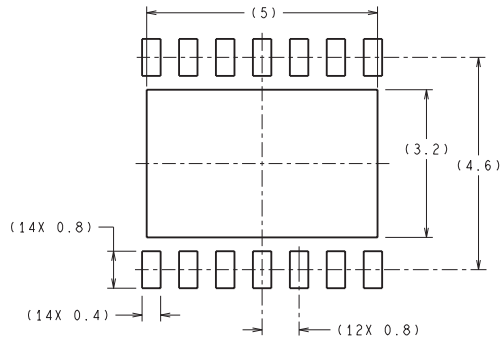

DIMENSIONS ARE IN MILLIMETERS  
DIMENSIONS IN ( ) FOR REFERENCE ONLY

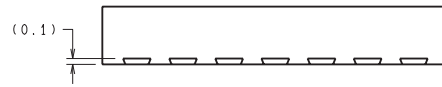

RECOMMENDED LAND PATTERN

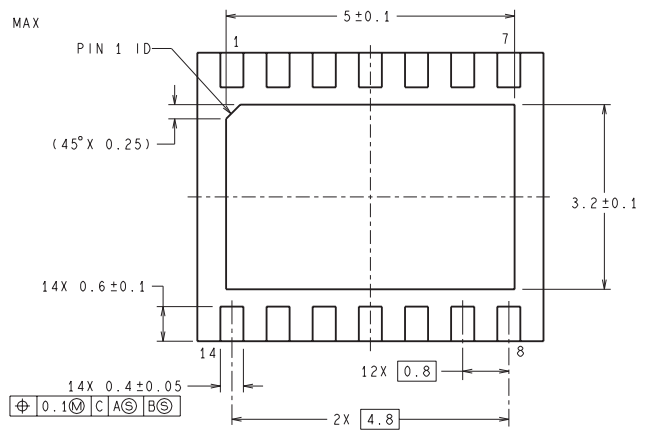
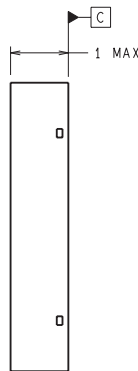
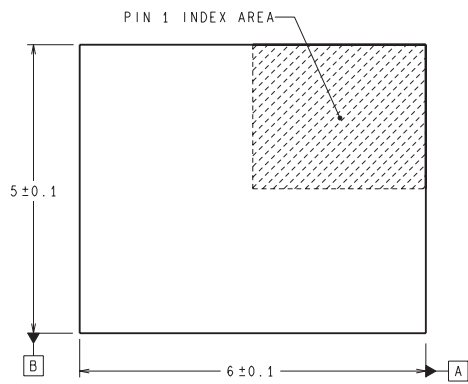

SRC14A (Rev A)

NDZ0007B

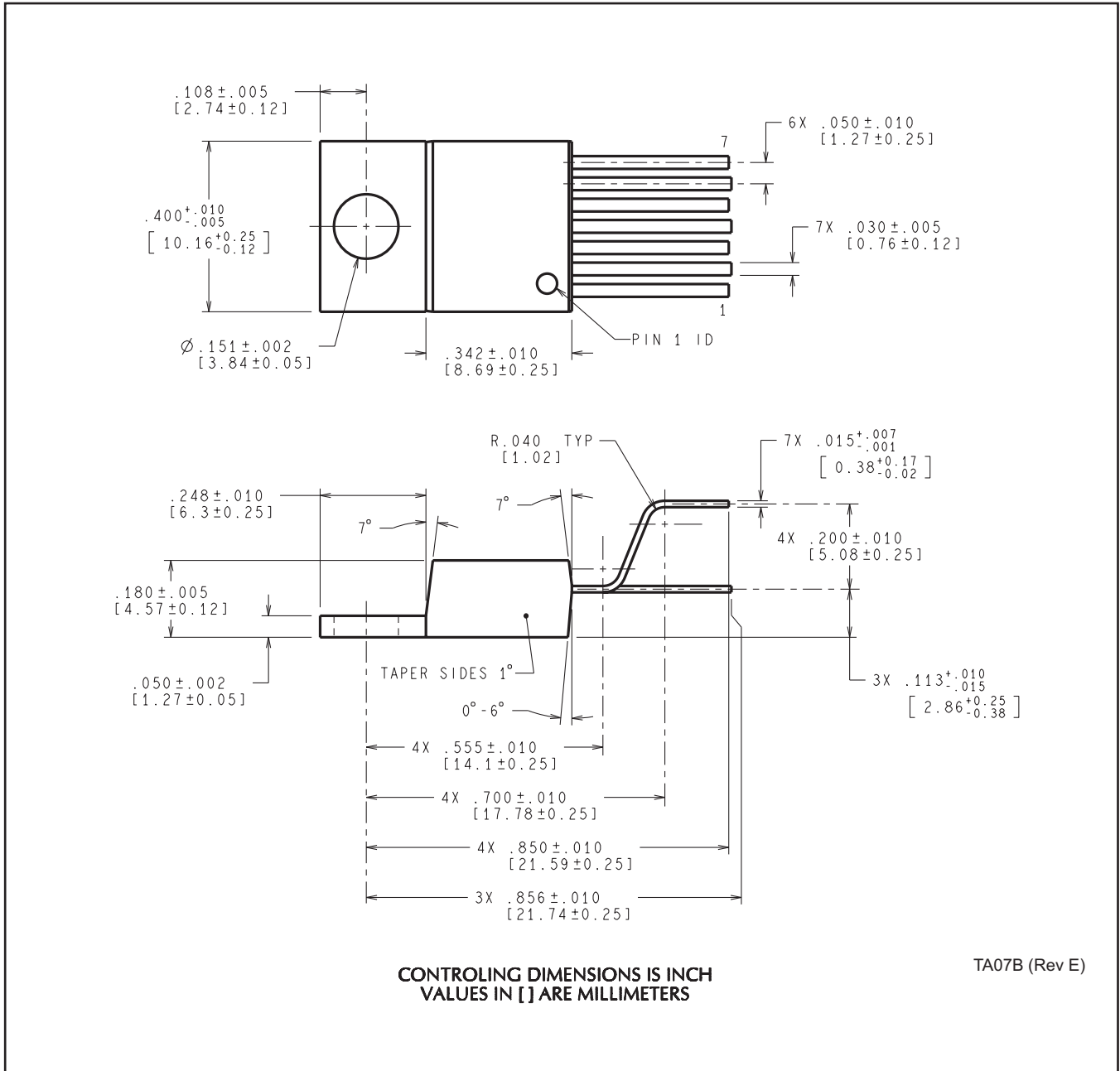

## IMPORTANT NOTICE AND DISCLAIMER

TI PROVIDES TECHNICAL AND RELIABILITY DATA (INCLUDING DATASHEETS), DESIGN RESOURCES (INCLUDING REFERENCE DESIGNS), APPLICATION OR OTHER DESIGN ADVICE, WEB TOOLS, SAFETY INFORMATION, AND OTHER RESOURCES "AS IS" AND WITH ALL FAULTS, AND DISCLAIMS ALL WARRANTIES, EXPRESS AND IMPLIED, INCLUDING WITHOUT LIMITATION ANY IMPLIED WARRANTIES OF MERCHANTABILITY, FITNESS FOR A PARTICULAR PURPOSE OR NON-INFRINGEMENT OF THIRD PARTY INTELLECTUAL PROPERTY RIGHTS.

These resources are intended for skilled developers designing with TI products. You are solely responsible for (1) selecting the appropriate TI products for your application, (2) designing, validating and testing your application, and (3) ensuring your application meets applicable standards, and any other safety, security, regulatory or other requirements.

These resources are subject to change without notice. TI grants you permission to use these resources only for development of an application that uses the TI products described in the resource. Other reproduction and display of these resources is prohibited. No license is granted to any other TI intellectual property right or to any third party intellectual property right. TI disclaims responsibility for, and you fully indemnify TI and its representatives against any claims, damages, costs, losses, and liabilities arising out of your use of these resources.

TI's products are provided subject to [TI's Terms of Sale](#), [TI's General Quality Guidelines](#), or other applicable terms available either on [ti.com](http://ti.com) or provided in conjunction with such TI products. TI's provision of these resources does not expand or otherwise alter TI's applicable warranties or warranty disclaimers for TI products. Unless TI explicitly designates a product as custom or customer-specified, TI products are standard, catalog, general purpose devices.

TI objects to and rejects any additional or different terms you may propose.

Copyright © 2026, Texas Instruments Incorporated

Last updated 10/2025