

LP5996 Dual Linear Regulator with 300mA and 150mA Outputs

 Check for Samples: [LP5996](#)

FEATURES

- 2 LDO Outputs with Independent Enable
- 1.5% Accuracy at Room Temperature, 3% over Temperature
- Thermal Shutdown Protection
- Stable with Ceramic Capacitors

APPLICATIONS

- Cellular Handsets
- PDA's
- Wireless Network Adaptors

KEY SPECIFICATIONS

- Input Voltage Range, 2.0V to 6.0V
- Low Dropout Voltage at 300mA, 210mV
- Ultra-Low I_Q (Enabled), 35 μ A
- Virtually Zero I_Q (Disabled), <10nA

PACKAGE

- All available in Lead Free option.
- 10 pin SON 3mm x 3mm

For other package options contact your Texas Instruments sales office.

DESCRIPTION

The LP5996 is a dual low dropout regulator. The first regulator can source 150mA, while the second is capable of sourcing 300mA.

The LP5996 provides 1.5% accuracy requiring an ultra low quiescent current of 35 μ A. Separate enable pins allow each output of the LP5996 to be shut down, drawing virtually zero current.

The LP5996 is designed to be stable with small footprint ceramic capacitors down to 1 μ F.

The LP5996 is available in fixed output voltages and comes in a 10 pin, 3mm x 3mm package.

Typical Application Circuit

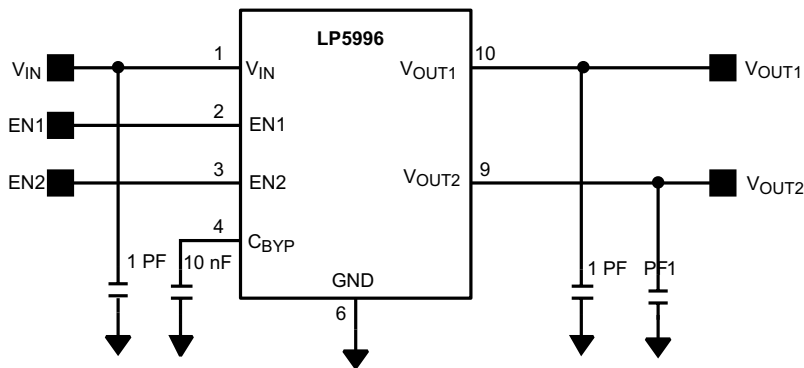

Please be aware that an important notice concerning availability, standard warranty, and use in critical applications of Texas Instruments semiconductor products and disclaimers thereto appears at the end of this data sheet.

All trademarks are the property of their respective owners.

Functional Block Diagram

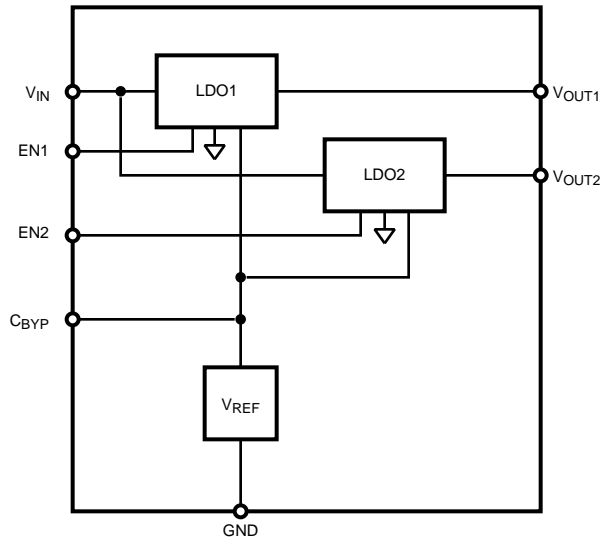

Pin Descriptions

Name	Pin No	Function
V _{IN}	1	Voltage Supply Input. Connect a 1μF capacitor between this pin and GND.
EN1	2	Enable Input to Regulator 1. Active high input. High = On. Low = OFF.
EN2	3	Enable Input to Regulator 2. Active high input. High = On. Low = OFF.
C _{BYP}	4	Internal Voltage Reference Bypass. Connect a 10nF capacitor from this pin to GND to reduce noise and improve line transient and PSRR. This pin may be left open.
N/C	5	No Connection. Do not connect to any other pin.
GND	6	Common Ground pin. Connect externally to exposed pad.
N/C	7	No Connection. Do not connect to any other pin.
N/C	8	No Connection. Do not connect to any other pin.
V _{OUT2}	9	Output of Regulator 2. 300mA maximum current output. Connect a 1μF capacitor between this pin to GND.
V _{OUT1}	10	Output of Regulator 1. 150mA maximum current output. Connect a 1μF capacitor between this pin to GND.
GND	Pad	Common Ground. Connect to Pin 6.

Connection Diagram

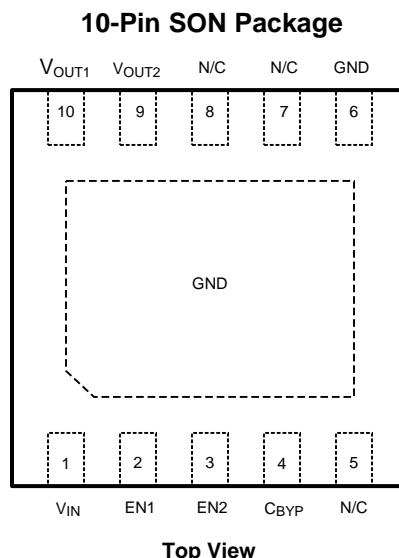

Figure 1. See Package Number DSC0010A



These devices have limited built-in ESD protection. The leads should be shorted together or the device placed in conductive foam during storage or handling to prevent electrostatic damage to the MOS gates.

Absolute Maximum Ratings ⁽¹⁾ ⁽²⁾ ⁽³⁾

Input Voltage	-0.3V to 6.5V
V_{OUT1} , V_{OUT2} , EN1, and EN2 Voltage to GND	-0.3V to $(V_{IN} + 0.3V)$ with 6.5V (max)
Junction Temperature (T_{J-MAX})	150°C
Lead/Pad Temp. ⁽⁴⁾	235°C
Storage Temperature	-65°C to 150°C
Continuous Power Dissipation Internally Limited ⁽⁵⁾	
ESD Rating ⁽⁶⁾	
Human Body Model	2.0kV
Machine Model	200V

- (1) All Voltages are with respect to the potential at the GND pin.
- (2) Absolute Maximum Ratings are limits beyond which damage can occur. Operating Ratings are conditions under which operation of the device is ensured. Operating Ratings do not imply ensured performance limits. For ensured performance limits and associated test conditions, see the Electrical Characteristics tables.
- (3) **If Military/Aerospace specified devices are required, please contact the Texas Instruments Sales Office / Distributors for availability and specifications.**
- (4) For detailed soldering specifications and information, please refer to Application Note AN-1187, Leadless Leadframe Package [SNOA401](#).
- (5) Internal thermal shutdown circuitry protects the device from permanent damage.
- (6) The human body model is 100pF discharged through a 1.5kΩ resistor into each pin. The machine model is a 200pF capacitor discharged directly into each pin.

Operating Ratings ⁽¹⁾ ⁽²⁾

Input Voltage	2.0V to 6.0V
EN1, EN2 Voltage	0 to $(V_{IN} + 0.3V)$ to 6.0V (max)

- (1) Absolute Maximum Ratings are limits beyond which damage can occur. Operating Ratings are conditions under which operation of the device is ensured. Operating Ratings do not imply ensured performance limits. For ensured performance limits and associated test conditions, see the Electrical Characteristics tables.
- (2) All Voltages are with respect to the potential at the GND pin.

Operating Ratings ⁽¹⁾ ⁽²⁾ (continued)

Junction Temperature	-40°C to 125°C
Ambient Temperature Range, T _A ⁽³⁾	-40°C to 85°C

- (3) The maximum ambient temperature (T_{A(max)}) is dependant on the maximum operating junction temperature (T_{J(max-op)} = 125°C), the maximum power dissipation of the device in the application (P_{D(max)}), and the junction to ambient thermal resistance of the part/package in the application (θ_{JA}), as given by the following equation: T_{A(max)} = T_{J(max-op)} - (θ_{JA} × P_{D(max)}).

Thermal Properties ⁽¹⁾

Junction To Ambient Thermal Resistance ⁽²⁾	
θ _{JA} SON-10 Package	55°C/W

- (1) Absolute Maximum Ratings are limits beyond which damage can occur. Operating Ratings are conditions under which operation of the device is ensured. Operating Ratings do not imply ensured performance limits. For ensured performance limits and associated test conditions, see the Electrical Characteristics tables.
- (2) Junction to ambient thermal resistance is dependant on the application and board layout. In applications where high maximum power dissipation is possible, special care must be paid to thermal dissipation issues in board design.

Electrical Characteristics ⁽¹⁾ ⁽²⁾

Unless otherwise noted, V_{EN} = 950mV, V_{IN} = V_{OUT} + 1.0V, or 2.0V, whichever is higher, where V_{OUT} is the higher of V_{OUT1} and V_{OUT2}. C_{IN} = 1 μF, I_{OUT} = 1 mA, C_{OUT1} = C_{OUT2} = 1.0μF.

Typical values and limits appearing in normal type apply for T_A = 25°C. Limits appearing in **boldface** type apply over the full junction temperature range for operation, -40 to +125°C.

Parameter		Test Conditions		Typ	Limit		Units
					Min	Max	
V _{IN}	Input Voltage	⁽³⁾			2	6	V
ΔV _{OUT}	Output Voltage Tolerance	I _{OUT} = 1mA	1.5V < V _{OUT} ≤ 3.3V		-2.5 -3.75	+2.5 +3.75	%
			V _{OUT} ≤ 1.5V		-2.75 -4	+2.75 +4	
	Line Regulation Error	V _{IN} = (V _{OUT(NOM)} + 1.0V) to 6.0V		0.03		0.3	%/V
	Load Regulation Error	I _{OUT} = 1mA to 150mA (LDO 1)		85		155	μV/mA
		I _{OUT} = 1mA to 300mA (LDO 2)		26		85	
V _{DO}	Dropout Voltage ⁽⁴⁾	I _{OUT} = 1mA to 150mA (LDO 1)		110		220	mV
		I _{OUT} = 1mA to 300mA (LDO 2)		210		550	
I _Q	Quiescent Current	LDO 1 ON, LDO 2 ON I _{OUT1} = I _{OUT2} = 0mA		35		100	μA
		LDO 1 ON, LDO 2 OFF I _{OUT1} = 150mA		45		110	
		LDO 1 OFF, LDO 2 ON I _{OUT2} = 300mA		45		110	
		LDO 1 ON, LDO 2 ON I _{OUT1} = 150mA, I _{OUT2} = 300mA		70		170	
		V _{EN1} = V _{EN2} = 0.4V		0.5		10	
I _{SC}	Short Circuit Current Limit	LDO 1		420		750	mA
		LDO 2		550		840	
I _{OUT}	Maximum Output Current	LDO 1			150		mA
		LDO 2			300		

(1) All Voltages are with respect to the potential at the GND pin.

(2) Min Max limits are ensured by design, test or statistical analysis. Typical numbers are not ensured, but do represent the most likely norm.

(3) V_{IN(MIN)} = V_{OUT(NOM)} + 0.5V, or 2.0V, whichever is higher.

(4) Dropout voltage is voltage difference between input and output at which the output voltage drops to 100mV below its nominal value. This parameter only for output voltages above 2.0V

Electrical Characteristics^{(1) (2)} (continued)

Unless otherwise noted, $V_{EN} = 950\text{mV}$, $V_{IN} = V_{OUT} + 1.0\text{V}$, or 2.0V , whichever is higher, where V_{OUT} is the higher of V_{OUT1} and V_{OUT2} . $C_{IN} = 1\ \mu\text{F}$, $I_{OUT} = 1\ \text{mA}$, $C_{OUT1} = C_{OUT2} = 1.0\ \mu\text{F}$.

Typical values and limits appearing in normal type apply for $T_A = 25^\circ\text{C}$. Limits appearing in **boldface** type apply over the full junction temperature range for operation, -40 to $+125^\circ\text{C}$.

Parameter		Test Conditions		Typ	Limit		Units
					Min	Max	
PSRR	Power Supply Rejection Ratio ⁽⁵⁾	$f = 1\text{kHz}$, $I_{OUT} = 1\text{mA}$ to 150mA $C_{BYP} = 10\text{nF}$	LDO1	58			dB
			LDO2	70			
		$f = 20\text{kHz}$, $I_{OUT} = 1\text{mA}$ to 150mA $C_{BYP} = 10\text{nF}$	LDO1	45			
			LDO2	60			
e_n	Output noise Voltage ⁽⁵⁾	$\text{BW} = 10\text{Hz}$ to 100kHz $C_{BYP} = 10\text{nF}$	$V_{OUT} = 0.8\text{V}$	36			μV_{RMS}
			$V_{OUT} = 3.3\text{V}$	75			
T_{SHUTDOWN}	Thermal Shutdown	Temperature		160			$^\circ\text{C}$
		Hysteresis		20			
Enable Control Characteristics							
I_{EN}	Input Current at V_{EN1} or V_{EN2}	$V_{EN} = 0.0\text{V}$		0.005		0.1	μA
		$V_{EN} = 6\text{V}$		2		5	
V_{IL}	Low Input Threshold					0.4	V
V_{IH}	High Input Threshold				0.95		V
Timing Characteristics							
T_{ON}	Turn On Time ⁽⁵⁾	To 95% Level $C_{BYP} = 10\text{nF}$		300			μs
Transient Response	Line Transient Response $ \delta V_{OUT} $ ⁽⁵⁾	$T_{\text{rise}} = T_{\text{fall}} = 10\ \mu\text{s}$ $\delta V_{IN} = 1\text{V}$, $C_{BYP} = 10\text{nF}$		20			mV (pk - pk)
		$T_{\text{rise}} = T_{\text{fall}} = 1\ \mu\text{s}$	LDO 1 $I_{OUT} = 1\text{mA}$ to 150mA	175			
			LDO 2 $I_{OUT} = 1\text{mA}$ to 300mA	150			
	Load Transient Response $ \delta V_{OUT} $ ⁽⁵⁾	$T_{\text{rise}} = T_{\text{fall}} = 1\ \mu\text{s}$					

(5) This electrical specification is ensured by design.

Output Capacitor, Recommended Specifications

Parameter		Test Conditions		Nom	Limit		Units
					Min	Max	
C_{OUT}	Output Capacitance	Capacitance ⁽¹⁾		1.0	0.7		μF
		ESR			5	500	$\text{m}\Omega$

(1) The Capacitor tolerance should be 30% or better over temperature. The full operating conditions for the application should be considered when selecting a suitable capacitor to ensure that the minimum value of capacitance is always met. Recommended capacitor is X7R. However, depending on the application, X5R, Y5V and Z5U can also be used. (See capacitor section in Applications Hints).

Typical Performance Characteristics.

Unless otherwise specified, $C_{IN} = 1.0\mu\text{F}$ Ceramic, $C_{OUT1} = C_{OUT2} = 1.0\mu\text{F}$ Ceramic, $C_{BYP} = 10\text{nF}$, $V_{IN} = V_{OUT2(NOM)} + 1.0\text{V}$, $T_A = 25^\circ\text{C}$, $V_{OUT1(NOM)} = 3.3\text{V}$, $V_{OUT2(NOM)} = 3.3\text{V}$, Enable pins are tied to V_{IN} .

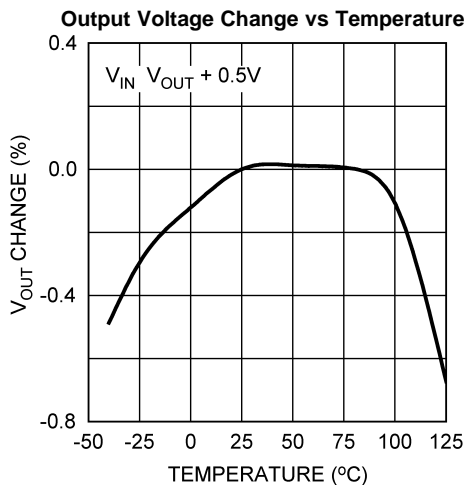

Figure 2.

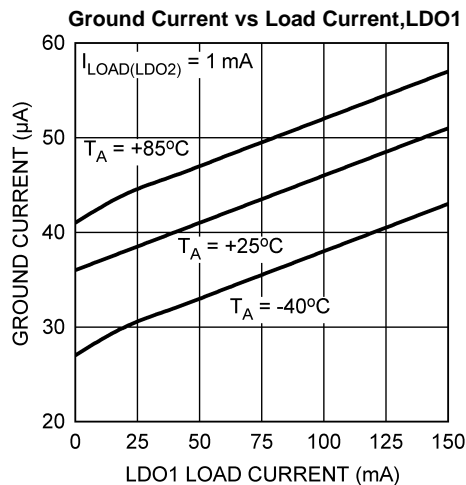

Figure 3.

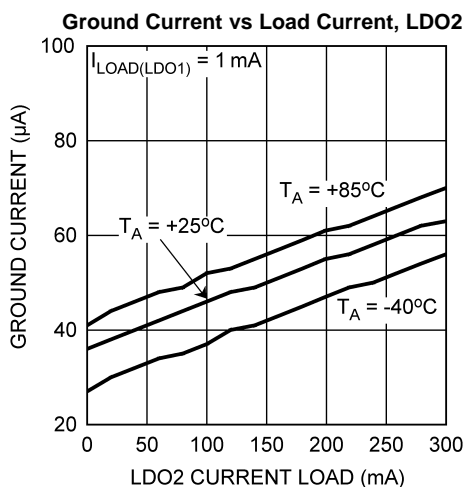

Figure 4.

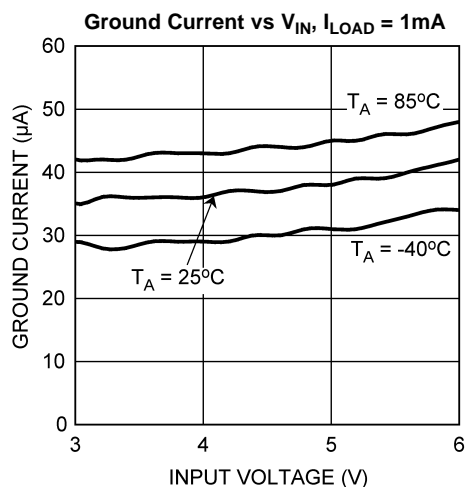

Figure 5.

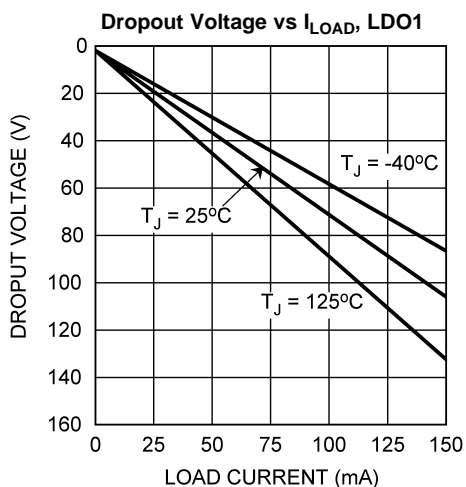

Figure 6.

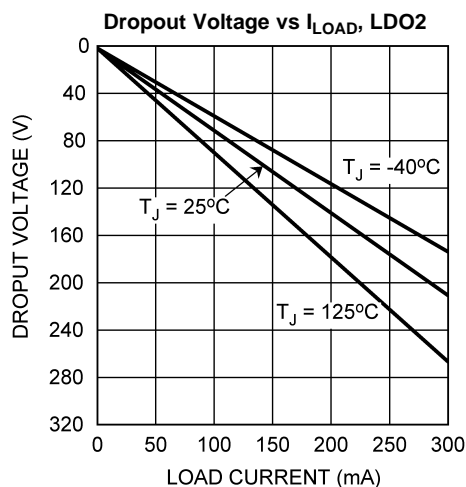

Figure 7.

Typical Performance Characteristics. (continued)

Unless otherwise specified, $C_{IN} = 1.0\mu\text{F}$ Ceramic, $C_{OUT1} = C_{OUT2} = 1.0\mu\text{F}$ Ceramic, $C_{BYP} = 10\text{nF}$, $V_{IN} = V_{OUT2(NOM)} + 1.0\text{V}$, $T_A = 25^\circ\text{C}$, $V_{OUT1(NOM)} = 3.3\text{V}$, $V_{OUT2(NOM)} = 3.3\text{V}$, Enable pins are tied to V_{IN} .

Line Transient, $C_{BYP} = 10\text{nF}$

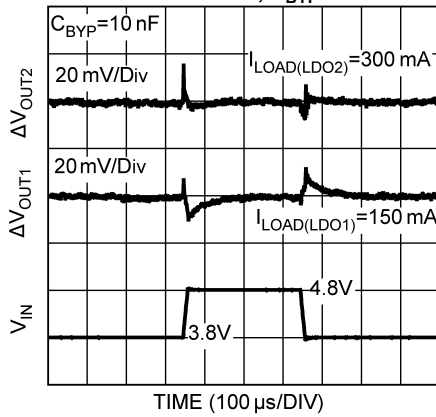

Figure 8.

Line Transient, $C_{BYP} = 0$

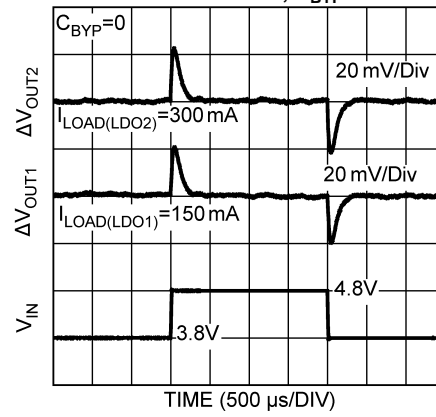

Figure 9.

Load Transient, LDO1

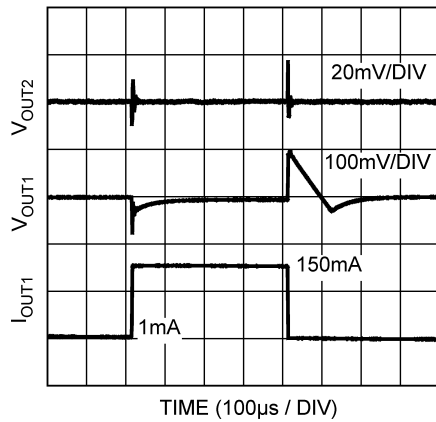

Figure 10.

Load Transient, LDO2

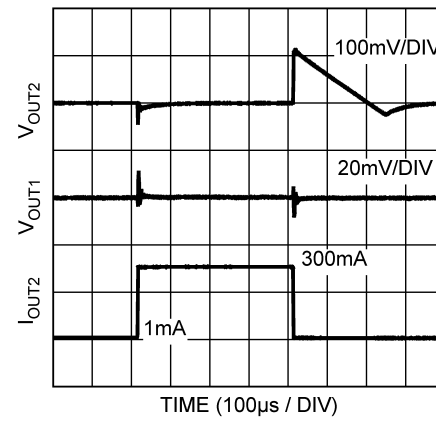

Figure 11.

Noise Density, LDO1

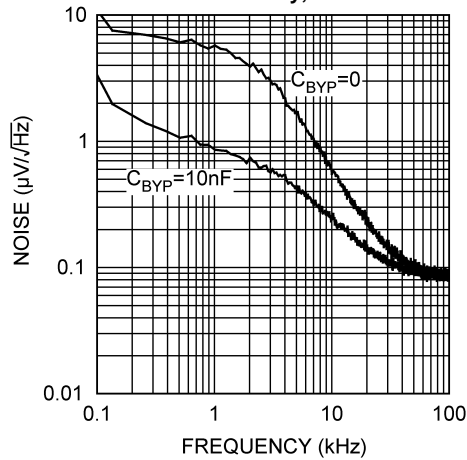

Figure 12.

Noise Density, LDO2

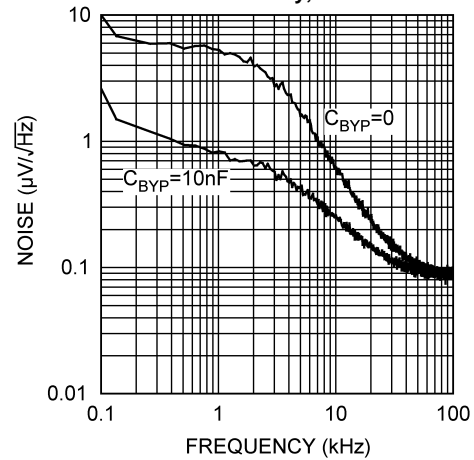

Figure 13.

Typical Performance Characteristics. (continued)

Unless otherwise specified, $C_{IN} = 1.0\mu\text{F}$ Ceramic, $C_{OUT1} = C_{OUT2} = 1.0\mu\text{F}$ Ceramic, $C_{BYP} = 10\text{nF}$, $V_{IN} = V_{OUT2(NOM)} + 1.0\text{V}$, $T_A = 25^\circ\text{C}$, $V_{OUT1(NOM)} = 3.3\text{V}$, $V_{OUT2(NOM)} = 3.3\text{V}$, Enable pins are tied to V_{IN} .

Short Circuit Current, LDO1

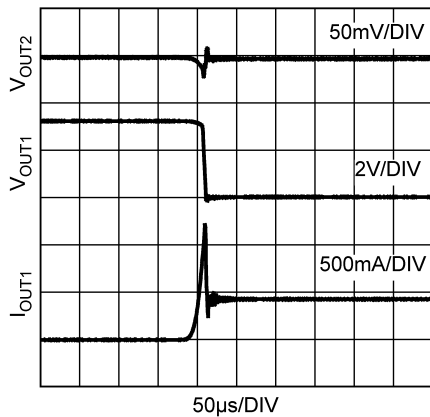

Figure 14.

Short Circuit Current, LDO2

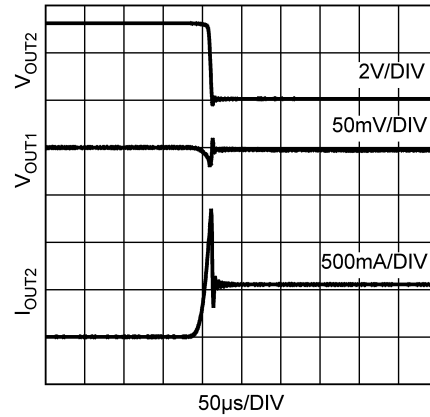

Figure 15.

Power Supply Rejection Ratio, LDO1

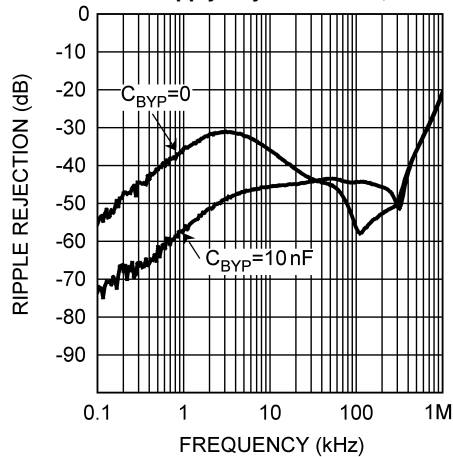

Figure 16.

Power Supply Rejection Ratio, LDO2

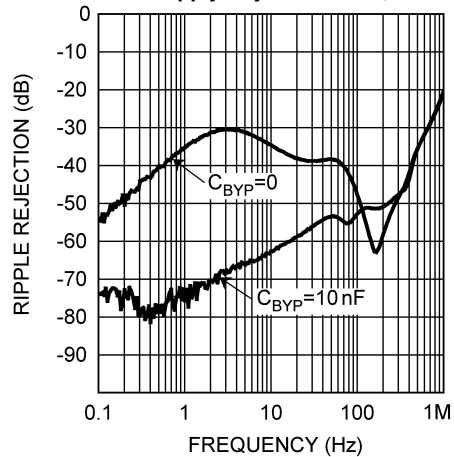

Figure 17.

Enable Start-up Time, $C_{BYP} = 0$

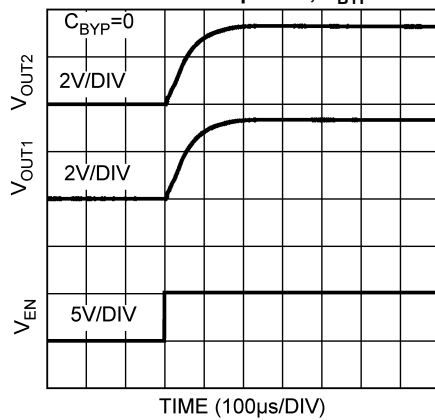

Figure 18.

Enable Start-up Time, $C_{BYP} = 10\text{nF}$

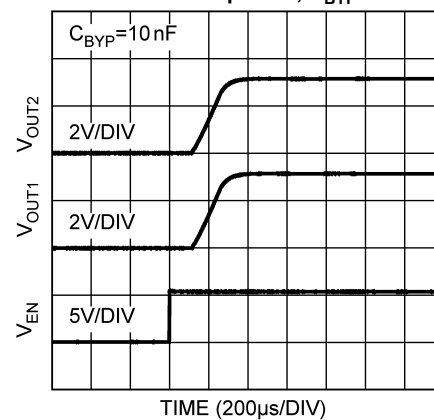

Figure 19.

APPLICATION HINTS

OPERATION DESCRIPTION

The LP5996 is a low quiescent current, power management IC, designed specifically for portable applications requiring minimum board space and smallest components. The LP5996 contains two independently selectable LDOs. The first is capable of sourcing 150mA at outputs between 0.8V and 3.3V. The second can source 300mA at an output voltage of 0.8V to 3.3V.

INPUT CAPACITOR

An input capacitor is required for stability. It is recommended that a 1.0 μ F capacitor be connected between the LP5996 input pin and ground (this capacitance value may be increased without limit).

This capacitor must be located a distance of not more than 1cm from the input pin and returned to a clean analogue ground. Any good quality ceramic, tantalum, or film capacitor may be used at the input.

Important: Tantalum capacitors can suffer catastrophic failures due to surge current when connected to a low-impedance source of power (like a battery or a very large capacitor). If a tantalum capacitor is used at the input, it must be ensured by the manufacturer to have a surge current rating sufficient for the application.

There are no requirements for the ESR (Equivalent Series Resistance) on the input capacitor, but tolerance and temperature coefficient must be considered when selecting the capacitor to ensure the capacitance will remain approximately 1.0 μ F over the entire operating temperature range.

OUTPUT CAPACITOR

The LP5996 is designed specifically to work with very small ceramic output capacitors. A 1.0 μ F ceramic capacitor (temperature types Z5U, Y5V or X7R) with ESR between 5m Ω to 500m Ω , is suitable in the LP5996 application circuit.

For this device the output capacitor should be connected between the V_{OUT} pin and ground.

It is also possible to use tantalum or film capacitors at the device output, C_{OUT} (or V_{OUT}), but these are not as attractive for reasons of size and cost (see the section Capacitor Characteristics).

The output capacitor must meet the requirement for the minimum value of capacitance and also have an ESR value that is within the range 5m Ω to 500m Ω for stability.

NO-LOAD STABILITY

The LP5996 will remain stable and in regulation with no external load. This is an important consideration in some circuits, for example CMOS RAM keep-alive applications.

CAPACITOR CHARACTERISTICS

The LP5996 is designed to work with ceramic capacitors on the output to take advantage of the benefits they offer. For capacitance values in the range of 0.47 μ F to 4.7 μ F, ceramic capacitors are the smallest, least expensive and have the lowest ESR values, thus making them best for eliminating high frequency noise. The ESR of a typical 1.0 μ F ceramic capacitor is in the range of 20m Ω to 40m Ω , which easily meets the ESR requirement for stability for the LP5996.

For both input and output capacitors, careful interpretation of the capacitor specification is required to ensure correct device operation. The capacitor value can change greatly, depending on the operating conditions and capacitor type.

In particular, the output capacitor selection should take account of all the capacitor parameters, to ensure that the specification is met within the application. The capacitance can vary with DC bias conditions as well as temperature and frequency of operation. Capacitor values will also show some decrease over time due to aging. The capacitor parameters are also dependant on the particular case size, with smaller sizes giving poorer performance figures in general. As an example, [Figure 20](#) shows a typical graph comparing different capacitor case sizes in a Capacitance vs. DC Bias plot. As shown in the graph, increasing the DC Bias condition can result

in the capacitance value falling below the minimum value given in the recommended capacitor specifications table ($0.7\mu\text{F}$ in this case). Note that the graph shows the capacitance out of spec for the 0402 case size capacitor at higher bias voltages. It is therefore recommended that the capacitor manufacturers' specifications for the nominal value capacitor are consulted for all conditions, as some capacitor sizes (e.g. 0402) may not be suitable in the actual application.

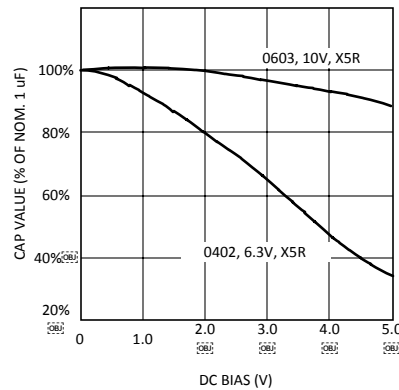

Figure 20. Graph Showing a Typical Variation in Capacitance vs DC Bias

The capacitance value of ceramic capacitors varies with temperature. The capacitor type X7R, which operates over a temperature range of -55°C to $+125^{\circ}\text{C}$, will only vary the capacitance to within $\pm 15\%$. The capacitor type X5R has a similar tolerance over a reduced temperature range of -55°C to $+85^{\circ}\text{C}$. Many large value ceramic capacitors, larger than $1\mu\text{F}$ are manufactured with Z5U or Y5V temperature characteristics. Their capacitance can drop by more than 50% as the temperature varies from 25°C to 85°C . Therefore X7R is recommended over Z5U and Y5V in applications where the ambient temperature will change significantly above or below 25°C .

Tantalum capacitors are less desirable than ceramic for use as output capacitors because they are more expensive when comparing equivalent capacitance and voltage ratings in the $0.47\mu\text{F}$ to $4.7\mu\text{F}$ range.

Another important consideration is that tantalum capacitors have higher ESR values than equivalent size ceramics. This means that while it may be possible to find a tantalum capacitor with an ESR value within the stable range, it would have to be larger in capacitance (which means bigger and more costly) than a ceramic capacitor with the same ESR value. It should also be noted that the ESR of a typical tantalum will increase about 2:1 as the temperature goes from 25°C down to -40°C , so some guard band must be allowed.

ENABLE CONTROL

The LP5996 features active high enable pins for each regulator, EN1 and EN2, which turns the corresponding LDO off when pulled low. The device outputs are enabled when the enable pins are set to high. When not enabled the regulator output is off and the device typically consumes 2nA.

If the application does not require the Enable switching feature, one or both enable pins should be tied to V_{IN} to keep the regulator output permanently on.

To ensure proper operation, the signal source used to drive the enable inputs must be able to swing above and below the specified turn-on/off voltage thresholds listed in the Electrical Characteristics section under V_{IL} and V_{IH} .

BYPASS CAPACITOR

The internal voltage reference circuit of the LP5996 is connected to the C_{BYP} pin via a high value internal resistor. An external capacitor, connected to this pin, forms a low-pass filter which reduces the noise level on both outputs of the device. There is also some improvement in PSSR and line transient performance. Internal circuitry ensures rapid charging of the C_{BYP} capacitor during start-up. A 10nF, high quality ceramic capacitor with either NPO or COG dielectric is recommended due to their low leakage characteristics and low noise performance.

SAFE AREA OF OPERATION

Due consideration should be given to operating conditions to avoid excessive thermal dissipation of the LP5996 or triggering its thermal shutdown circuit. When both outputs are enabled, the total power dissipation will be $P_{D(LDO1)} + P_{D(LDO2)}$ where $PD = (V_{IN} - V_{OUT}) \times I_{OUT}$ for each LDO

In general, device options which have a large difference in output voltage will dissipate more power with both outputs enabled, due to the input voltage required for the higher output voltage LDO. In such cases, especially at elevated ambient temperature, it may not be possible to operate both outputs at maximum current at the same time.

REVISION HISTORY

Changes from Revision B (April 2013) to Revision C	Page
• Changed layout of National Data Sheet to TI format	11

PACKAGING INFORMATION

Orderable part number	Status (1)	Material type (2)	Package Pins	Package qty Carrier	RoHS (3)	Lead finish/ Ball material (4)	MSL rating/ Peak reflow (5)	Op temp (°C)	Part marking (6)
LP5996SD-1018/NOPB	Active	Production	WSON (DSC) 10	1000 SMALL T&R	Yes	SN	Level-1-260C-UNLIM	-	L224B
LP5996SD-1018/NOPB.A	Active	Production	WSON (DSC) 10	1000 SMALL T&R	Yes	SN	Level-1-260C-UNLIM	-40 to 85	L224B
LP5996SD-1833/NOPB	Active	Production	WSON (DSC) 10	1000 SMALL T&R	Yes	SN	Level-1-260C-UNLIM	-	L225B
LP5996SD-1833/NOPB.A	Active	Production	WSON (DSC) 10	1000 SMALL T&R	Yes	SN	Level-1-260C-UNLIM	-40 to 85	L225B
LP5996SD-2533/NOPB	Active	Production	WSON (DSC) 10	1000 SMALL T&R	Yes	SN	Level-1-260C-UNLIM	-	L226B
LP5996SD-2533/NOPB.A	Active	Production	WSON (DSC) 10	1000 SMALL T&R	Yes	SN	Level-1-260C-UNLIM	-40 to 85	L226B
LP5996SD-2828/NOPB	Active	Production	WSON (DSC) 10	1000 SMALL T&R	Yes	SN	Level-1-260C-UNLIM	-40 to 85	L180B
LP5996SD-2828/NOPB.A	Active	Production	WSON (DSC) 10	1000 SMALL T&R	Yes	SN	Level-1-260C-UNLIM	-40 to 85	L180B
LP5996SD-3033/NOPB	Active	Production	WSON (DSC) 10	1000 SMALL T&R	Yes	SN	Level-1-260C-UNLIM	-40 to 85	L179B
LP5996SD-3033/NOPB.A	Active	Production	WSON (DSC) 10	1000 SMALL T&R	Yes	SN	Level-1-260C-UNLIM	-40 to 85	L179B
LP5996SD-3333/NOPB	Active	Production	WSON (DSC) 10	1000 SMALL T&R	Yes	SN	Level-1-260C-UNLIM	-40 to 85	L182B
LP5996SD-3333/NOPB.A	Active	Production	WSON (DSC) 10	1000 SMALL T&R	Yes	SN	Level-1-260C-UNLIM	-40 to 85	L182B

(1) **Status:** For more details on status, see our [product life cycle](#).

(2) **Material type:** When designated, preproduction parts are prototypes/experimental devices, and are not yet approved or released for full production. Testing and final process, including without limitation quality assurance, reliability performance testing, and/or process qualification, may not yet be complete, and this item is subject to further changes or possible discontinuation. If available for ordering, purchases will be subject to an additional waiver at checkout, and are intended for early internal evaluation purposes only. These items are sold without warranties of any kind.

(3) **RoHS values:** Yes, No, RoHS Exempt. See the [TI RoHS Statement](#) for additional information and value definition.

(4) **Lead finish/Ball material:** Parts may have multiple material finish options. Finish options are separated by a vertical ruled line. Lead finish/Ball material values may wrap to two lines if the finish value exceeds the maximum column width.

(5) **MSL rating/Peak reflow:** The moisture sensitivity level ratings and peak solder (reflow) temperatures. In the event that a part has multiple moisture sensitivity ratings, only the lowest level per JEDEC standards is shown. Refer to the shipping label for the actual reflow temperature that will be used to mount the part to the printed circuit board.

(6) **Part marking:** There may be an additional marking, which relates to the logo, the lot trace code information, or the environmental category of the part.

Multiple part markings will be inside parentheses. Only one part marking contained in parentheses and separated by a "-" will appear on a part. If a line is indented then it is a continuation of the previous line and the two combined represent the entire part marking for that device.

Important Information and Disclaimer: The information provided on this page represents TI's knowledge and belief as of the date that it is provided. TI bases its knowledge and belief on information provided by third parties, and makes no representation or warranty as to the accuracy of such information. Efforts are underway to better integrate information from third parties. TI has taken and continues to take reasonable steps to provide representative and accurate information but may not have conducted destructive testing or chemical analysis on incoming materials and chemicals. TI and TI suppliers consider certain information to be proprietary, and thus CAS numbers and other limited information may not be available for release.

In no event shall TI's liability arising out of such information exceed the total purchase price of the TI part(s) at issue in this document sold by TI to Customer on an annual basis.

TAPE AND REEL INFORMATION

QUADRANT ASSIGNMENTS FOR PIN 1 ORIENTATION IN TAPE

*All dimensions are nominal

Device	Package Type	Package Drawing	Pins	SPQ	Reel Diameter (mm)	Reel Width W1 (mm)	A0 (mm)	B0 (mm)	K0 (mm)	P1 (mm)	W (mm)	Pin1 Quadrant
LP5996SD-1018/NOPB	WSON	DSC	10	1000	177.8	12.4	3.3	3.3	1.0	8.0	12.0	Q1
LP5996SD-1833/NOPB	WSON	DSC	10	1000	177.8	12.4	3.3	3.3	1.0	8.0	12.0	Q1
LP5996SD-2533/NOPB	WSON	DSC	10	1000	177.8	12.4	3.3	3.3	1.0	8.0	12.0	Q1
LP5996SD-2828/NOPB	WSON	DSC	10	1000	177.8	12.4	3.3	3.3	1.0	8.0	12.0	Q1
LP5996SD-3033/NOPB	WSON	DSC	10	1000	177.8	12.4	3.3	3.3	1.0	8.0	12.0	Q1
LP5996SD-3333/NOPB	WSON	DSC	10	1000	177.8	12.4	3.3	3.3	1.0	8.0	12.0	Q1

TAPE AND REEL BOX DIMENSIONS

*All dimensions are nominal

Device	Package Type	Package Drawing	Pins	SPQ	Length (mm)	Width (mm)	Height (mm)
LP5996SD-1018/NOPB	WSON	DSC	10	1000	208.0	191.0	35.0
LP5996SD-1833/NOPB	WSON	DSC	10	1000	208.0	191.0	35.0
LP5996SD-2533/NOPB	WSON	DSC	10	1000	208.0	191.0	35.0
LP5996SD-2828/NOPB	WSON	DSC	10	1000	208.0	191.0	35.0
LP5996SD-3033/NOPB	WSON	DSC	10	1000	208.0	191.0	35.0
LP5996SD-3333/NOPB	WSON	DSC	10	1000	208.0	191.0	35.0

DSC0010A

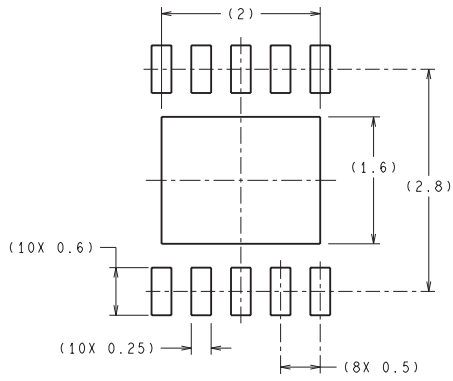

RECOMMENDED LAND PATTERN

DIMENSIONS ARE IN MILLIMETERS
DIMENSIONS IN () FOR REFERENCE ONLY

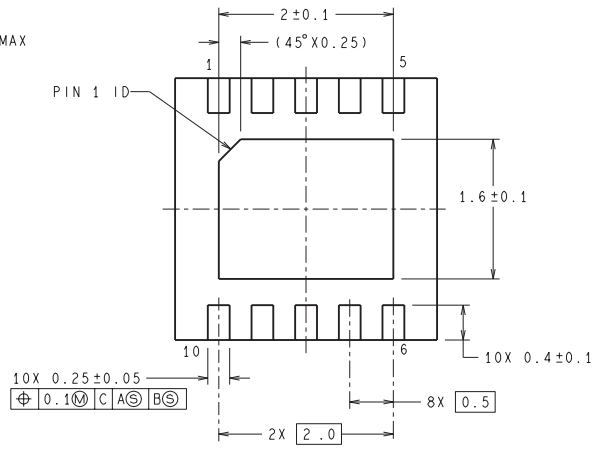
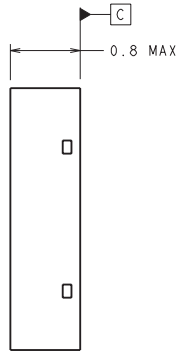
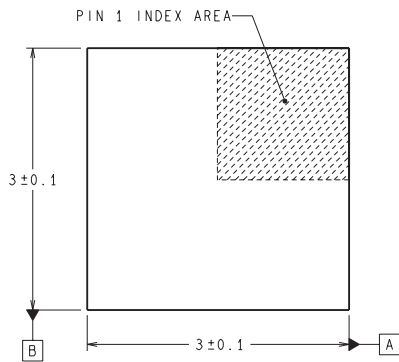
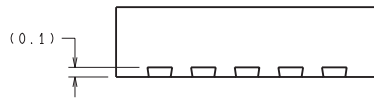

SDA10A (Rev A)

IMPORTANT NOTICE AND DISCLAIMER

TI PROVIDES TECHNICAL AND RELIABILITY DATA (INCLUDING DATASHEETS), DESIGN RESOURCES (INCLUDING REFERENCE DESIGNS), APPLICATION OR OTHER DESIGN ADVICE, WEB TOOLS, SAFETY INFORMATION, AND OTHER RESOURCES "AS IS" AND WITH ALL FAULTS, AND DISCLAIMS ALL WARRANTIES, EXPRESS AND IMPLIED, INCLUDING WITHOUT LIMITATION ANY IMPLIED WARRANTIES OF MERCHANTABILITY, FITNESS FOR A PARTICULAR PURPOSE OR NON-INFRINGEMENT OF THIRD PARTY INTELLECTUAL PROPERTY RIGHTS.

These resources are intended for skilled developers designing with TI products. You are solely responsible for (1) selecting the appropriate TI products for your application, (2) designing, validating and testing your application, and (3) ensuring your application meets applicable standards, and any other safety, security, regulatory or other requirements.

These resources are subject to change without notice. TI grants you permission to use these resources only for development of an application that uses the TI products described in the resource. Other reproduction and display of these resources is prohibited. No license is granted to any other TI intellectual property right or to any third party intellectual property right. TI disclaims responsibility for, and you fully indemnify TI and its representatives against any claims, damages, costs, losses, and liabilities arising out of your use of these resources.

TI's products are provided subject to [TI's Terms of Sale](#), [TI's General Quality Guidelines](#), or other applicable terms available either on [ti.com](#) or provided in conjunction with such TI products. TI's provision of these resources does not expand or otherwise alter TI's applicable warranties or warranty disclaimers for TI products. Unless TI explicitly designates a product as custom or customer-specified, TI products are standard, catalog, general purpose devices.

TI objects to and rejects any additional or different terms you may propose.

Copyright © 2025, Texas Instruments Incorporated

Last updated 10/2025