

## Dual, 200mA Output, Low Noise, High PSRR Low-Dropout Linear Regulators

### FEATURES

- Dual, 200mA High-Performance LDOs
- Low Total Quiescent Current: 90 $\mu$ A with Both LDOs Enabled
- Low Noise: 70 $\mu$ V<sub>RMS</sub>/V
- Active Output Pulldown (TPS719xx)
- Independent Enables for Each LDO
- PSRR: 65dB at 1kHz, 45dB at 1MHz
- Available in Multiple Fixed-Output Voltage Combinations from 0.9V to 3.6V Using Innovative Factory EEPROM Programming
- Fast Start-Up Time: 160 $\mu$ s
- Over-Current, Over-Temperature and Under-Voltage Protection
- Low Dropout: 230mV at 200mA
- Stable with 1 $\mu$ F Ceramic Output Capacitor
- Available in 2mm  $\times$  2mm SON-6 and 6-Ball WCSP Packages

### DESCRIPTION

The TPS718xx and TPS719xx families of low-dropout (LDO) regulators offer a high power-supply rejection ratio (PSRR), low noise, fast start-up, and excellent line and load transient responses while consuming a very low 90 $\mu$ A (typical) at no load ground current with both LDOs enabled. The TPS719xx also provides an active pulldown circuit to quickly discharge output loads. The TPS718xx and TPS719xx are stable with ceramic capacitors and use an advanced BiCMOS fabrication process to yield a typical dropout voltage of 230mV at 200mA output loads. The TPS718xx and TPS719xx also use a precision voltage reference and feedback loop to achieve 3% overall accuracy over all load, line, process, and temperature variations. Both families of devices are fully specified from  $T_J = -40^{\circ}\text{C}$  to  $+125^{\circ}\text{C}$  and are offered in 2mm  $\times$  2mm SON-6 and 6-ball Wafer Chip-Scale (WCSP) packages that are ideal for applications such as mobile handsets and WLAN that require good thermal dissipation while maintaining a very small footprint.

### APPLICATIONS

- Digital Cameras and Camera Modules
- Cellular Camera and TV Phones
- Wireless LAN, Bluetooth<sup>®</sup>
- Handheld Products

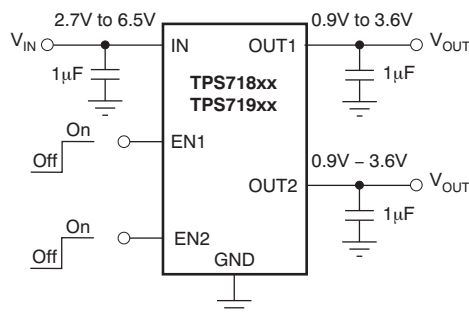

Typical Application Circuit

TPS718xx, TPS719xx  
DRV Package  
2mm  $\times$  2mm SON-6  
(Top View)

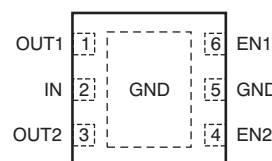

TPS718xx, TPS719xx  
YZC Package  
6-BALL WCSP  
(Top View)

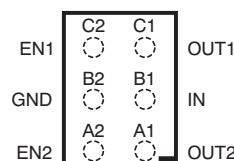

TPS718Axx, TPS719Axx  
YZC Package  
6-BALL WCSP  
(Top View)

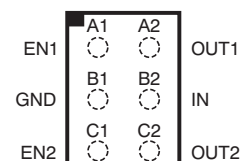

Please be aware that an important notice concerning availability, standard warranty, and use in critical applications of Texas Instruments semiconductor products and disclaimers thereto appears at the end of this data sheet.

Bluetooth is a registered trademark of Bluetooth SIG, Inc.  
All other trademarks are the property of their respective owners.



This integrated circuit can be damaged by ESD. Texas Instruments recommends that all integrated circuits be handled with appropriate precautions. Failure to observe proper handling and installation procedures can cause damage.

ESD damage can range from subtle performance degradation to complete device failure. Precision integrated circuits may be more susceptible to damage because very small parametric changes could cause the device not to meet its published specifications.

### ORDERING INFORMATION<sup>(1)</sup>

PRODUCT	V <sub>OUT</sub> <sup>(2)(3)</sup>
TPS718xx-yywwwz TPS718Axx-yywwwz TPS719xx-yywwwz TPS719Axx-yywwwz	<b>A</b> denotes device with rotated pin 1 orientation of wafer-chip-scale package. <b>XX</b> is nominal output voltage for LDO1 (for example, 28 = 2.8V). <b>YY</b> is nominal output voltage for LDO2. <b>WWW</b> is package designator. <b>Z</b> is tape and reel quantity (R = 3000, T = 250).
<b>Examples:</b> TPS71918-285DRVR TPS719185-33DRVR	<b>XX</b> = 18 = 1.8V, <b>YYY</b> = 285 = 2.85V <b>XXX</b> = 185 = 1.85V, <b>YY</b> = 33 = 3.3V <b>DRV</b> = 2mm x 2mm SON package <b>Z</b> = R = 3000 piece reel

- (1) For the most current package and ordering information see the Package Option Addendum at the end of this document, or see the TI website at [www.ti.com](http://www.ti.com).
- (2) Both outputs are programmable from 0.9V to 3.6V in 50mV increments.
- (3) Output voltages from 0.9V to 3.6V in 50mV increments are available through the use of innovative factory EEPROM programming; minimum order quantities may apply. Contact factory for details and availability.

### ABSOLUTE MAXIMUM RATINGS<sup>(1)</sup>

Over operating temperature range (unless otherwise noted). All voltages are with respect to GND.

PARAMETER	TPS718xx, TPS719xx	UNIT
Input voltage range, V <sub>IN</sub>	-0.3 to +7.0	V
Enable voltage range, V <sub>EN1</sub> and V <sub>EN2</sub>	-0.3 to V <sub>IN</sub> + 0.3V	V
Output voltage range, V <sub>OUT</sub>	-0.3 to +7.0	V
Peak output current	Internally limited	
Output short-circuit duration	Indefinite	
Junction temperature range, T <sub>J</sub>	-55 to +150	°C
Storage temperature range, T <sub>STG</sub>	-55 to +150	°C
Total continuous power dissipation, P <sub>DISS</sub>	See <a href="#">Dissipation Ratings</a> Table	
ESD rating, HBM	2	kV
ESD rating, CDM	500	V

- (1) Stresses above these ratings may cause permanent damage. Exposure to absolute maximum conditions for extended periods may degrade device reliability. These are stress ratings only, and functional operation of the device at these or any other conditions beyond those specified is not implied.

### DISSIPATION RATINGS

BOARD	PACKAGE	R <sub>θJC</sub>	R <sub>θJA</sub>	DERATING FACTOR ABOVE T <sub>A</sub> = +25°C	T <sub>A</sub> < +25°C	T <sub>A</sub> = +70°C	T <sub>A</sub> = +85°C
High-K <sup>(1)</sup>	DRV	20°C/W	95°C/W	10.53mW/°C	1053mW	579mW	421mW
High-K <sup>(1)</sup>	YZC	27°C/W	190°C/W	5.3mW/°C	530mW	295mW	215mW

- (1) The JEDEC high-K (2s2p) board used to derive this data was a 3in × 3in, multilayer board with 1-ounce internal power and ground planes and 2-ounce copper traces on top and bottom of the board.

## ELECTRICAL CHARACTERISTICS

Over operating temperature range ( $T_J = -40^\circ\text{C}$  to  $+125^\circ\text{C}$ ),  $V_{IN} = V_{OUT(TYP)} + 0.5\text{V}$  or  $2.7\text{V}$ , whichever is greater;  
 $I_{OUT} = 0.5\text{mA}$ ,  $V_{EN1} = V_{EN2} = V_{IN}$ ,  $C_{OUT} = 1.0\mu\text{F}$ , unless otherwise noted. Typical values are at  $T_J = +25^\circ\text{C}$ .

PARAMETER		TEST CONDITIONS	MIN	TYP	MAX	UNIT
$V_{IN}$	Input voltage range <sup>(1)</sup>		2.7		6.5	V
$V_{OUT1}, V_{OUT2}$	Output voltage range		0.9		3.6	V
$V_{OUT1}, V_{OUT2}$	Output accuracy	Nominal	$T_J = +25^\circ\text{C}$			mV
		Over $V_{IN}, I_{OUT},$ Temp	$V_{OUT} + 0.5\text{V} \leq V_{IN} \leq 6.5\text{V}$ $0\text{mA} \leq I_{OUT} \leq 200\text{mA}$	-3.0	+3.0	%
$\Delta V_{OUT} / \Delta V_{IN}$	Line regulation	$V_{OUT(NOM)} + 0.5\text{V} \leq V_{IN} \leq 6.5\text{V}$ , $I_{OUT} = 5\text{mA}$		130		$\mu\text{V/V}$
$\Delta V_{OUT} / \Delta I_{OUT}$	Load regulation	$0\text{mA} \leq I_{OUT} \leq 200\text{mA}$		75		$\mu\text{V/mA}$
$V_{DO}$	Dropout voltage <sup>(2)</sup> ( $V_{IN} = V_{OUT(NOM)} - 0.1\text{V}$ )	$I_{OUT} = 200\text{mA}$		230	400	mV
$I_{CL}$	Output current limit (per output)	$V_{OUT} = 0.9 \times V_{OUT(NOM)}$	240	340	575	mA
$I_{GND}$	Ground pin current	$I_{OUT1} = I_{OUT2} = 0.1\text{mA}$		90	160	$\mu\text{A}$
		$I_{OUT1} = I_{OUT2} = 200\text{mA}$		250		$\mu\text{A}$
$I_{SHDN}$	Shutdown current ( $I_{GND}$ )	$V_{EN1,2} \leq 0.4\text{V}$ , $2.7\text{V} \leq V_{IN} < 4.5\text{V}$ , $T_J = -40^\circ\text{C}$ to $+85^\circ\text{C}$		0.3	3.0	$\mu\text{A}$
		$V_{EN1,2} \leq 0.4\text{V}$ , $4.5\text{V} \leq V_{IN} \leq 6.5\text{V}$ , $T_J = -40^\circ\text{C}$ to $+85^\circ\text{C}$		1.8		$\mu\text{A}$
PSRR	Power-supply rejection ratio $V_{IN} = 3.8\text{V}$ , $V_{OUT} = 2.8\text{V}$ , $I_{OUT} = 200\text{mA}$	$f = 100\text{Hz}$		63		dB
		$f = 1\text{kHz}$		63		dB
		$f = 10\text{kHz}$		72		dB
		$f = 100\text{kHz}$		58		dB
		$f = 1\text{MHz}$		44		dB
$V_N$	Output noise voltage BW = 100Hz to 100kHz			$70 \times V_{OUT}$		$\mu\text{V}_{RMS}$
$T_{STR}$	Startup time <sup>(3)</sup>	$R_L = 14\Omega$ , $V_{OUT} = 2.8\text{V}$ , $C_{OUT} = 1.0\mu\text{F}$		160		$\mu\text{s}$
$T_{SHUT}$	Shutdown time <sup>(4), (5)</sup> (TPS719xx only)	$R_L = \infty$ , $C_{OUT} = 1.0\mu\text{F}$ , $V_{OUT} = 2.8\text{V}$		180		$\mu\text{s}$
$V_{EN(HI)}$	Enable high (enabled) (EN1 and EN2)	$V_{IN} \leq 5.5\text{V}$	1.2		6.5	V
		$5.5\text{V} < V_{IN} \leq 6.5\text{V}$	1.25		6.5	V
$V_{EN(LO)}$	Enable low (shutdown) (EN1 and EN2)		0		0.4	V
$I_{EN}$	Enable pin current, enabled (EN1 and EN2)	$EN1 = EN2 = 6.5\text{V}$		0.04	1.0	$\mu\text{A}$
UVLO	Undervoltage lockout	$V_{IN}$ rising	2.38	2.45	2.52	V
	Hysteresis	$V_{IN}$ falling		150		mV
$T_{SD}$	Thermal shutdown temperature	Shutdown, temperature increasing		+160		$^\circ\text{C}$
		Reset, temperature decreasing		+140		$^\circ\text{C}$
$T_J$	Operating junction temperature		-40		+125	$^\circ\text{C}$

- (1) Minimum  $V_{IN} = V_{OUT} + V_{DO}$  or  $2.7\text{V}$ , whichever is greater.
- (2)  $V_{DO}$  is not measured for devices with  $V_{OUT(NOM)} < 2.8\text{V}$  because minimum  $V_{IN} = 2.7\text{V}$ .
- (3) Time from  $V_{EN} = 1.25\text{V}$  to  $V_{OUT} = 95\%$  ( $V_{OUT(NOM)}$ ).
- (4) Time from  $V_{EN} = 0.4\text{V}$  to  $V_{OUT} = 5\%$  ( $V_{OUT(NOM)}$ ).
- (5) See [Shutdown](#) section in the Applications Information for more details.

DEVICE INFORMATION

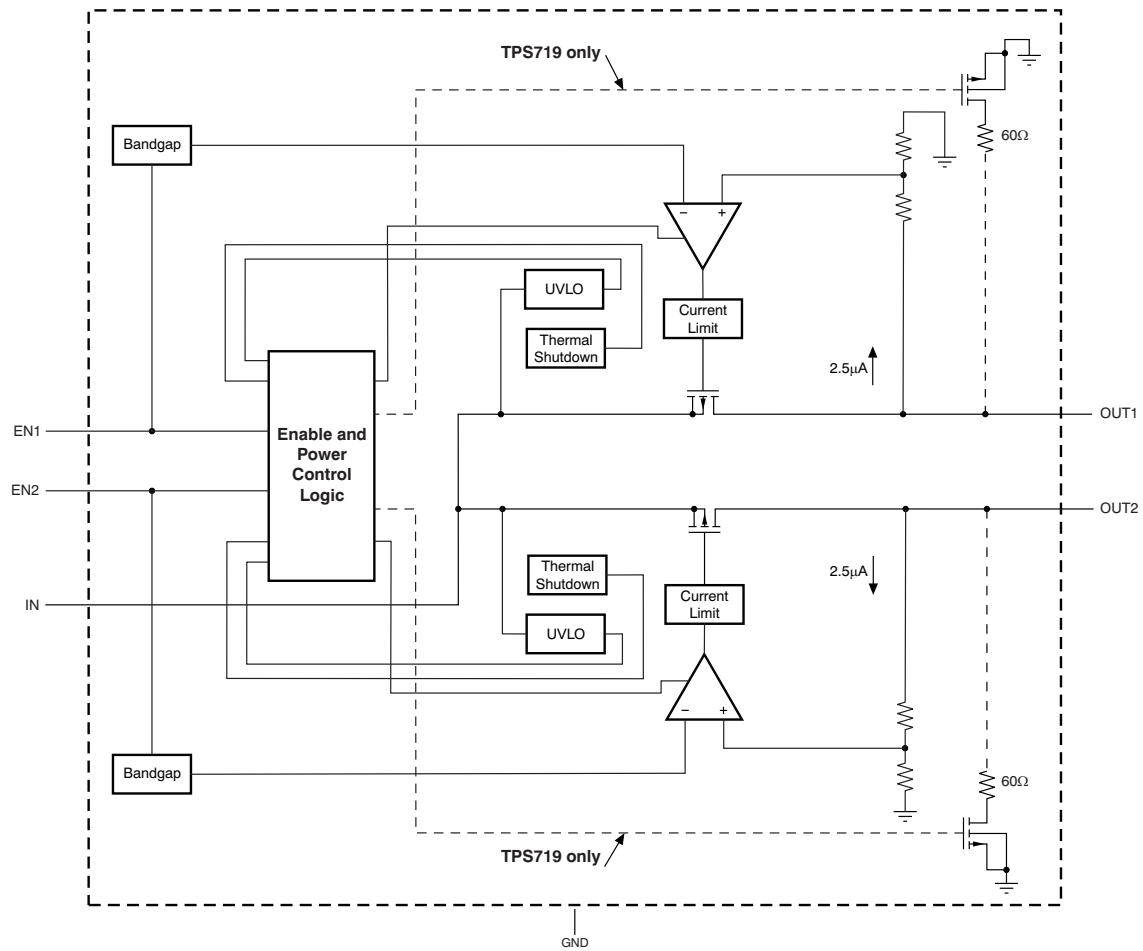
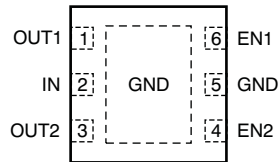
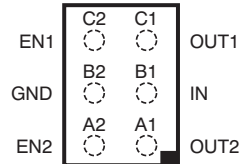
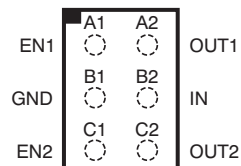

Figure 1. Functional Block Diagram

**DRV PACKAGE  
SON-6  
(TOP VIEW)**

**YZC PACKAGE  
6-BALL WCSP  
(TOP VIEW)**

 TPS718xx  
TPS719xx

**YZC PACKAGE  
6-BALL WCSP  
(TOP VIEW)**

 TPS718Axx  
TPS719Axx

**PIN DESCRIPTIONS**

TPS718xx TPS719xx		TPS718Axx <sup>(1)</sup> TPS719Axx <sup>(1)</sup>		DESCRIPTION
NAME	DRV	YZC	YZC	
OUT1	1	C1	A2	Output of Regulator 1. A small ceramic capacitor (typically $\geq 1\mu\text{F}$ ) is needed from this pin to ground to assure stability.
IN	2	B1	B2	Input supply to both regulators.
OUT2	3	A1	C2	Output of Regulator 2. A small ceramic capacitor (typically $\geq 1\mu\text{F}$ ) is needed from this pin to ground to assure stability.
EN2	4	A2	C1	Enable pin for Regulator 2. Driving the Enable pin (EN2) high turns on Regulator 2. Driving this pin low puts Regulator 2 into shutdown mode, reducing operating current.
GND	5	B2	B1	Ground. DRV thermal pad should also be connected to ground.
EN1	6	C2	A1	Enable pin for Regulator 1. Driving the Enable pin (EN1) high turns on Regulator 1. Driving this pin low puts Regulator 1 into shutdown mode, reducing operating current.

 (1) **A** option denotes devices with rotated Pin 1 orientation on Wafer Chipscale packages.

**TYPICAL CHARACTERISTICS**

Over operating temperature range ( $T_J = -40^{\circ}\text{C}$  to  $+125^{\circ}\text{C}$ ),  $V_{IN} = V_{OUT(TYP)} + 0.5\text{V}$  or  $2.7\text{V}$ , whichever is greater;  $I_{OUT} = 0.5\text{mA}$ ,  $V_{EN1} = V_{EN2} = V_{IN}$ ,  $C_{OUT} = 1.0\mu\text{F}$ , unless otherwise noted. Typical values are at  $T_J = +25^{\circ}\text{C}$ .

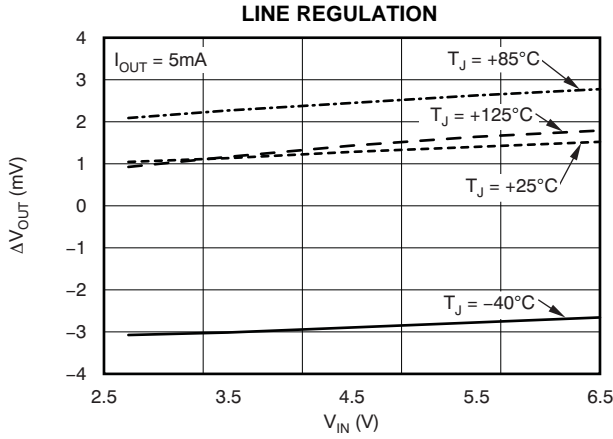

Figure 2.

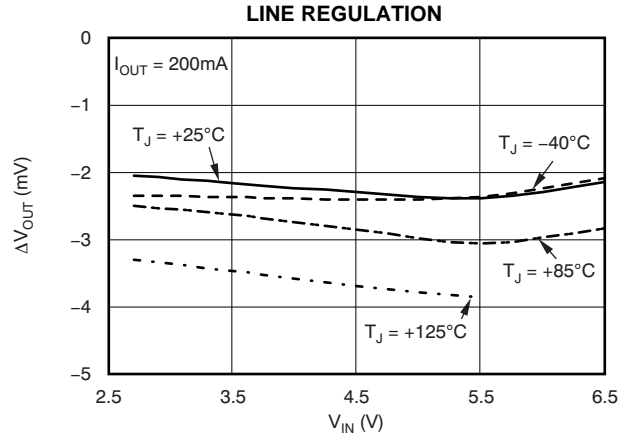

Figure 3.

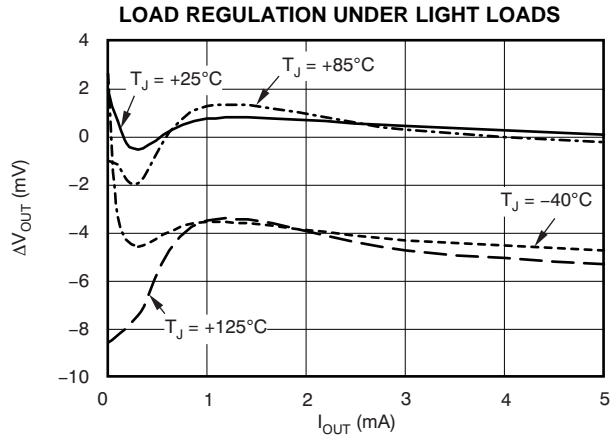

Figure 4.

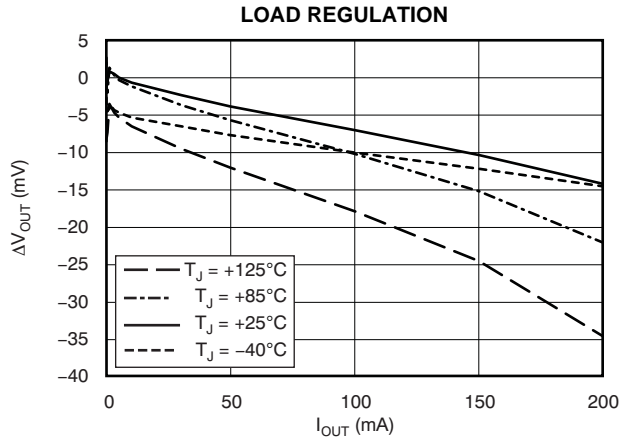

Figure 5.

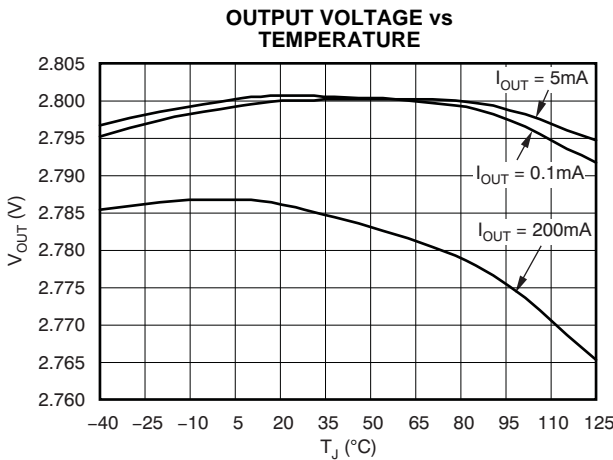

Figure 6.

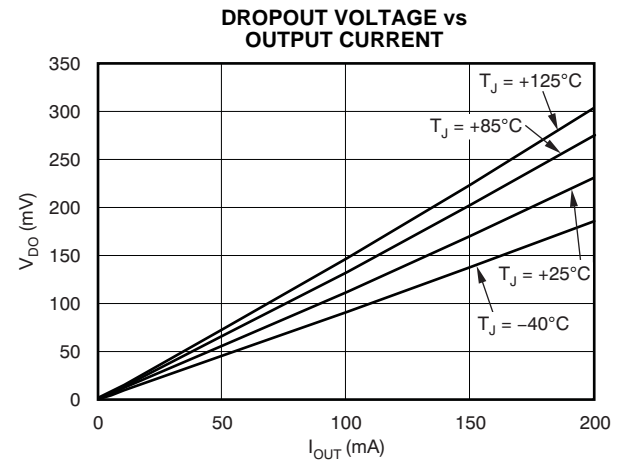

Figure 7.

**TYPICAL CHARACTERISTICS (continued)**

Over operating temperature range ( $T_J = -40^{\circ}\text{C}$  to  $+125^{\circ}\text{C}$ ),  $V_{IN} = V_{OUT(TYP)} + 0.5\text{V}$  or  $2.7\text{V}$ , whichever is greater;  $I_{OUT} = 0.5\text{mA}$ ,  $V_{EN1} = V_{EN2} = V_{IN}$ ,  $C_{OUT} = 1.0\mu\text{F}$ , unless otherwise noted. Typical values are at  $T_J = +25^{\circ}\text{C}$ .

**GROUND PIN CURRENT vs OUTPUT CURRENT**

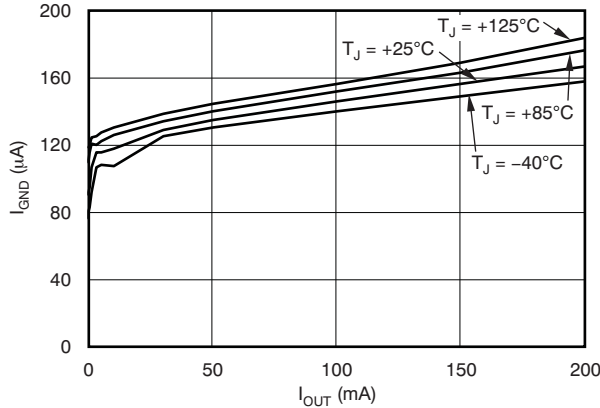

Figure 8.

**GROUND PIN CURRENT vs INPUT VOLTAGE**

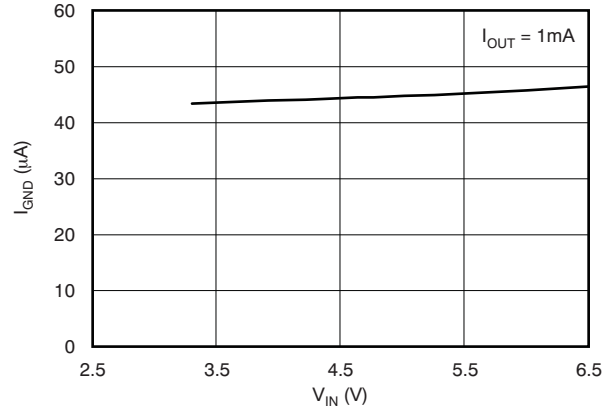

Figure 9.

**GROUND PIN CURRENT vs TEMPERATURE (BOTH LDOs ENABLED)**

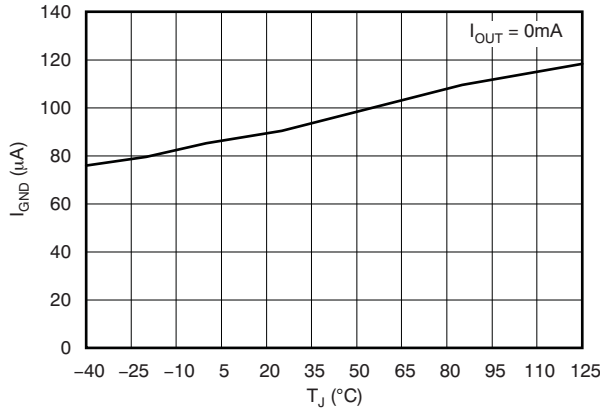

Figure 10.

**SHUTDOWN CURRENT vs INPUT VOLTAGE**

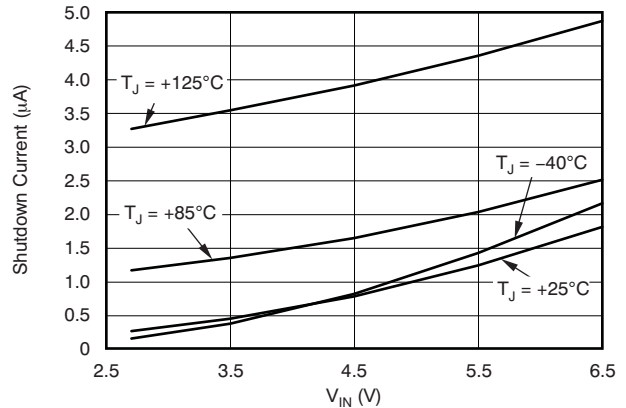

Figure 11.

**CURRENT LIMIT vs INPUT VOLTAGE**

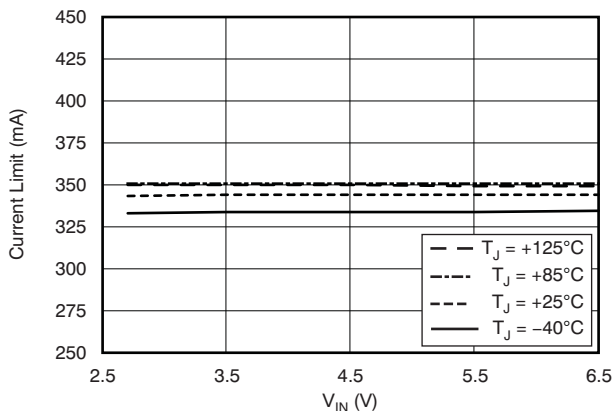

Figure 12.

**POWER-SUPPLY RIPPLE REJECTION vs FREQUENCY ( $V_{IN} - V_{OUT} = 0.5\text{V}$ )**

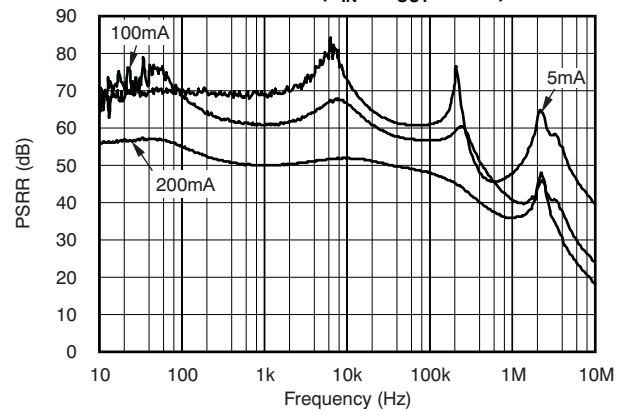

Figure 13.

**TYPICAL CHARACTERISTICS (continued)**

Over operating temperature range ( $T_J = -40^{\circ}\text{C}$  to  $+125^{\circ}\text{C}$ ),  $V_{IN} = V_{OUT(TYP)} + 0.5\text{V}$  or  $2.7\text{V}$ , whichever is greater;  $I_{OUT} = 0.5\text{mA}$ ,  $V_{EN1} = V_{EN2} = V_{IN}$ ,  $C_{OUT} = 1.0\mu\text{F}$ , unless otherwise noted. Typical values are at  $T_J = +25^{\circ}\text{C}$ .

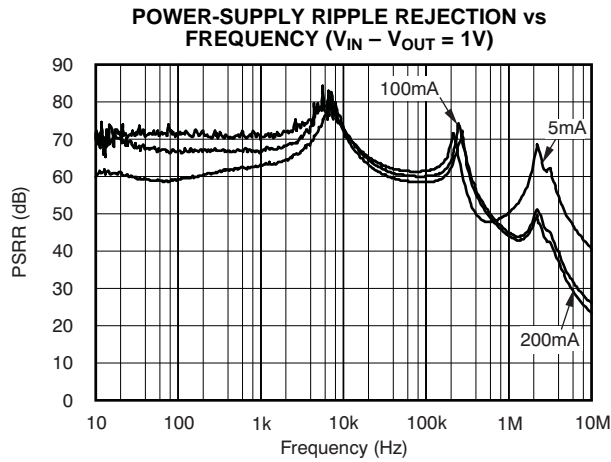

Figure 14.

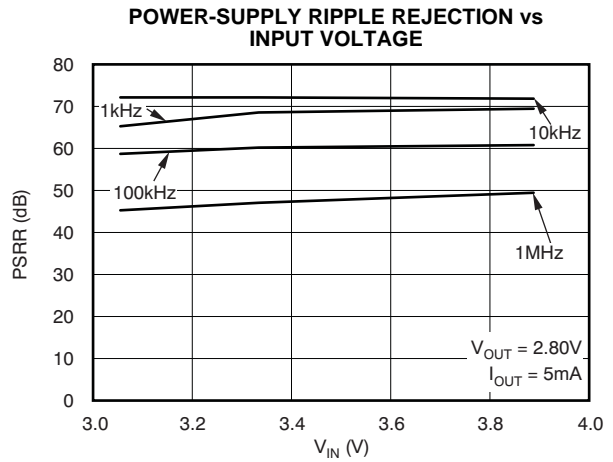

Figure 15.

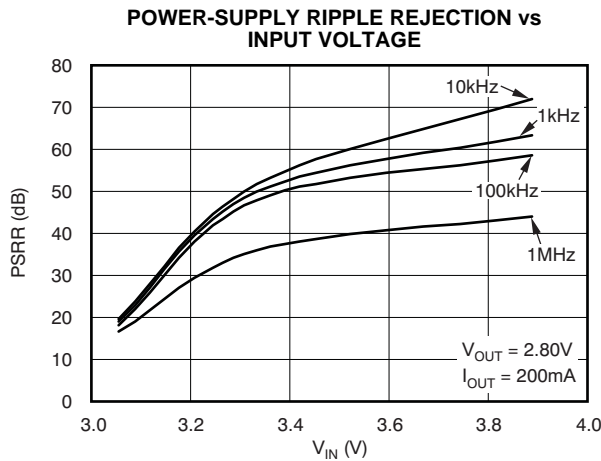

Figure 16.

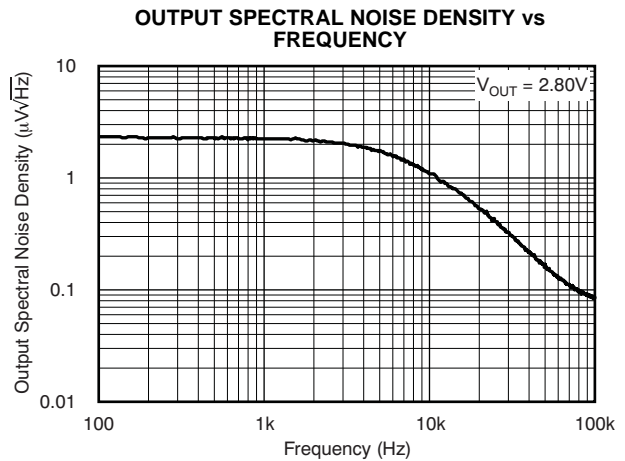

Figure 17.

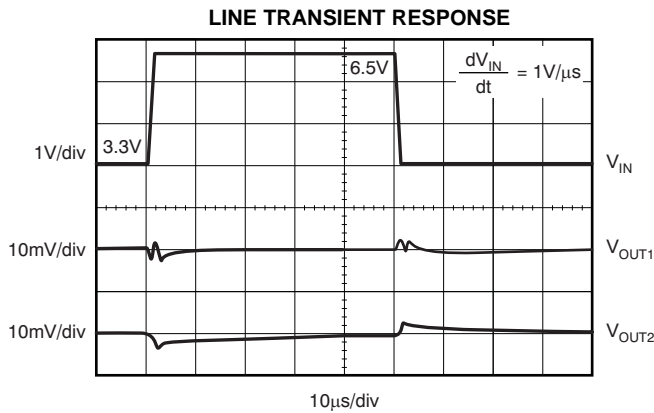

Figure 18.

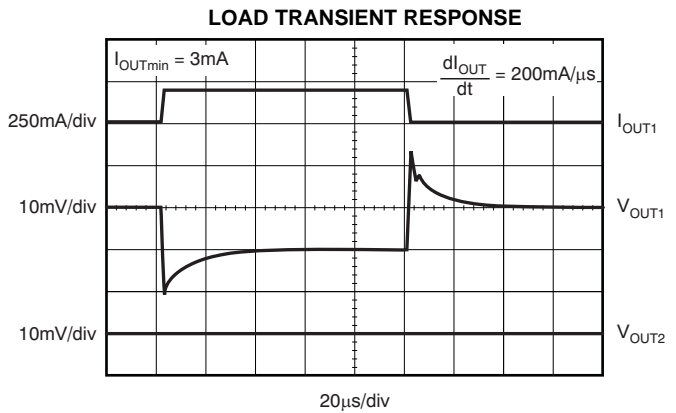
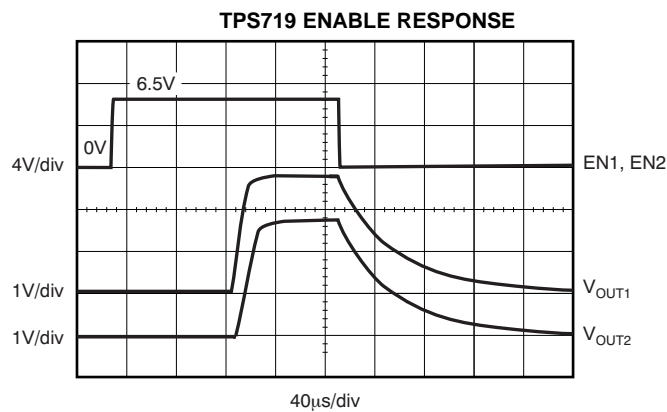

Figure 19.

**TYPICAL CHARACTERISTICS (continued)**

Over operating temperature range ( $T_J = -40^{\circ}\text{C}$  to  $+125^{\circ}\text{C}$ ),  $V_{IN} = V_{OUT(TYP)} + 0.5\text{V}$  or  $2.7\text{V}$ , whichever is greater;  $I_{OUT} = 0.5\text{mA}$ ,  $V_{EN1} = V_{EN2} = V_{IN}$ ,  $C_{OUT} = 1.0\mu\text{F}$ , unless otherwise noted. Typical values are at  $T_J = +25^{\circ}\text{C}$ .



**Figure 20.**

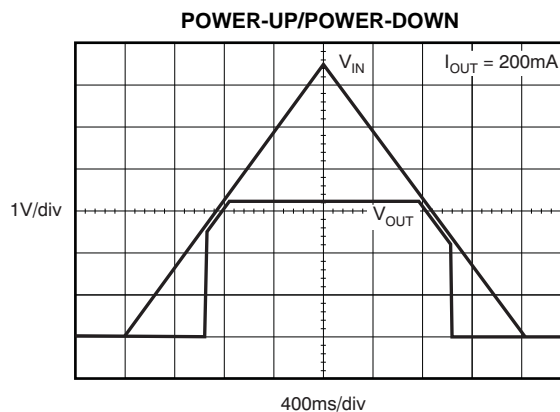

**Figure 21.**

## APPLICATION INFORMATION

The TPS718xx/TPS719xx belong to a family of new generation LDO regulators that use innovative circuitry to achieve ultra-wide bandwidth and high loop gain, resulting in extremely high PSRR (up to 1MHz) at very low headroom ( $V_{IN} - V_{OUT}$ ). These features, combined with low noise, two independent enables, low ground pin current and ultra-small packaging, make this part ideal for portable applications. This family of regulators offer sub-bandgap output voltages, current limit and thermal protection, and is fully specified from  $-40^{\circ}\text{C}$  to  $+125^{\circ}\text{C}$ .

Figure 22 shows the basic circuit connections.

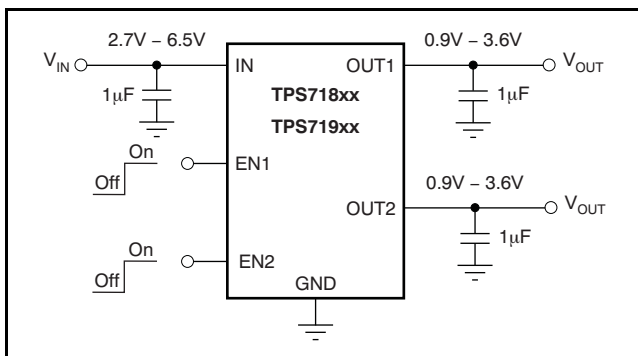

Figure 22. Typical Application Circuit

### Input and Output Capacitor Requirements

Although an input capacitor is not required for stability, it is good analog design practice to connect a  $0.1\mu\text{F}$  to  $1.0\mu\text{F}$  low equivalent series resistance (ESR) capacitor across the input supply near the regulator. This capacitor counteracts reactive input sources and improves transient response, noise rejection, and ripple rejection. A higher-value capacitor may be necessary if large, fast rise-time load transients are anticipated or if the device is located close to the power source. If source impedance is not sufficiently low, a  $0.1\mu\text{F}$  input capacitor may be necessary to ensure stability.

The TPS718xx/TPS719xx are designed to be stable with standard ceramic capacitors of values  $1.0\mu\text{F}$  or larger at the output. X5R- and X7R-type capacitors are best because they have minimal variation in value and ESR over temperature. Maximum ESR should be  $<1.0\Omega$ .

### Board Layout Recommendations to Improve PSRR and Noise Performance

To improve ac performance such as PSRR, output noise, and transient response, it is recommended that the board be designed with separate ground planes for  $V_{IN}$  and  $V_{OUT}$ , with each ground plane connected only at the GND pin of the device. In addition, the ground connection for the output capacitor should connect directly to the GND pin of the device. High ESR capacitors may degrade PSRR.

### Internal Current Limit

The TPS718xx/TPS719xx internal current limits help protect the regulator during fault conditions. During current limit, the output sources a fixed amount of current that is largely independent of output voltage. For reliable operation, the device should not be operated in a current limit state for extended periods of time.

The PMOS pass element in the TPS718xx/TPS719xx has a built-in body diode that conducts current when the voltage at OUT exceeds the voltage at IN. This current is not limited, so if extended reverse voltage operation is anticipated, external limiting to 5% of rated output current may be appropriate.

### Shutdown

The enable pin (EN) is active high and is compatible with standard and low voltage, TTL-CMOS levels. When shutdown capability is not required, EN can be connected to IN. The TPS719 with internal active output pulldown circuitry discharges the output with a time constant ( $t$ ) of:

$$t = 3 \left[ \frac{60 \times R_L}{60 + R_L} \right] \times C_{OUT}$$

with:

$R_L$  = output load resistance

$C_{OUT}$  = output capacitance

### Dropout Voltage

The TPS718xx/TPS719xx use a PMOS pass transistor to achieve low dropout. When  $(V_{IN} - V_{OUT})$  is less than the dropout voltage ( $V_{DO}$ ), the PMOS pass device is in its linear region of operation and the input-to-output resistance is the  $R_{DS(ON)}$  of the PMOS pass element.  $V_{DO}$  approximately scales with output current because the PMOS device behaves like a resistor in dropout.

As with any linear regulator, PSRR and transient response are degraded as  $(V_{IN} - V_{OUT})$  approaches dropout. This effect is shown in [Figure 13](#) and [Figure 14](#) in the [Typical Characteristics](#) section.

### Transient Response

As with any regulator, increasing the size of the output capacitor will reduce over/undershoot magnitude but increase duration of the transient response.

### Undervoltage Lock-Out (UVLO)

The TPS718xx/TPS719xx utilize an undervoltage lock-out circuit to keep the output shut off until internal circuitry is operating properly. The UVLO circuit has a de-glitch feature so that it typically ignores undershoot transients on the input if they are less than 50 $\mu$ s duration. On the TPS719xx, the active pulldown discharges  $V_{OUT}$  when the device is in UVLO off condition. However, the input voltage needs to be greater than 0.8V for active pulldown to work.

### Minimum Load

The TPS718xx/TPS719xx are stable with no output load. Traditional PMOS LDO regulators suffer from lower loop gain at very light output loads. The TPS718xx/TPS719xx employ an innovative, low-current mode circuit under very light or no-load conditions, resulting in improved output voltage regulation performance down to zero output current.

## THERMAL INFORMATION

### Thermal Protection

Thermal protection disables the output when the junction temperature rises to approximately +160°C, allowing the device to cool. When the junction temperature cools to approximately +140°C the output circuitry is again enabled. Depending on power dissipation, thermal resistance, and ambient temperature, the thermal protection circuit may cycle on and off. This cycling limits the dissipation of the regulator, protecting it from damage due to overheating.

Any tendency to activate the thermal protection circuit indicates excessive power dissipation or an inadequate heatsink. For reliable operation, junction temperature should be limited to +125°C maximum. To estimate the margin of safety in a complete design (including heatsink), increase the ambient temperature until the thermal protection is triggered; use worst-case loads and signal conditions. For good reliability, thermal protection should trigger at least +35°C above the maximum expected ambient condition of your particular application. This configuration produces a worst-case junction temperature of +125°C at the highest expected ambient temperature and worst-case load.

The internal protection circuitry of the TPS718xx/TPS719xx has been designed to protect against overload conditions. It was not intended to replace proper heatsinking. Continuously running the TPS718xx/TPS719xx into thermal shutdown degrades device reliability.

### Power Dissipation

The ability to remove heat from the die is different for each package type, presenting different considerations in the printed circuit board (PCB) layout. The PCB area around the device that is free of other components moves the heat from the device to the ambient air. Performance data for JEDEC low- and high-K boards are given in the [Dissipation Ratings](#) table. Using heavier copper increases the effectiveness in removing heat from the device. The addition of plated through-holes to heat-dissipating layers also improves the heatsink effectiveness.

Power dissipation depends on input voltage and load conditions. Power dissipation ( $P_D$ ) is equal to the product of the output current times the voltage drop across the output pass element ( $V_{IN}$  to  $V_{OUT}$ ), as shown in [Equation 1](#):

$$P_D = (V_{IN} - V_{OUT}) \times I_{OUT} \quad (1)$$

### Package Mounting

Solder pad footprint recommendations for the TPS718xx/TPS719xxx are available from the Texas Instruments web site at [www.ti.com](http://www.ti.com).



**PACKAGING INFORMATION**

Orderable part number	Status (1)	Material type (2)	Package   Pins	Package qty   Carrier	RoHS (3)	Lead finish/ Ball material (4)	MSL rating/ Peak reflow (5)	Op temp (°C)	Part marking (6)
<a href="#">TPS71812-33DRVR</a>	Active	Production	WSON (DRV)   6	3000   LARGE T&R	Yes	NIPDAUAG	Level-1-260C-UNLIM	-40 to 125	BVC
TPS71812-33DRVR.B	Active	Production	WSON (DRV)   6	3000   LARGE T&R	Yes	NIPDAUAG	Level-1-260C-UNLIM	-40 to 125	BVC
<a href="#">TPS71812-33DRVT</a>	Active	Production	WSON (DRV)   6	250   SMALL T&R	Yes	NIPDAUAG	Level-1-260C-UNLIM	-40 to 125	BVC
TPS71812-33DRVT.B	Active	Production	WSON (DRV)   6	250   SMALL T&R	Yes	NIPDAUAG	Level-1-260C-UNLIM	-40 to 125	BVC
<a href="#">TPS71818-33DRVR</a>	Active	Production	WSON (DRV)   6	3000   LARGE T&R	Yes	NIPDAU   NIPDAUAG	Level-1-260C-UNLIM	-40 to 125	OEI
TPS71818-33DRVR.B	Active	Production	WSON (DRV)   6	3000   LARGE T&R	Yes	NIPDAUAG	Level-1-260C-UNLIM	-40 to 125	OEI
<a href="#">TPS71818-33DRVT</a>	Active	Production	WSON (DRV)   6	250   SMALL T&R	Yes	NIPDAU   NIPDAUAG	Level-1-260C-UNLIM	-40 to 125	OEI
TPS71818-33DRVT.B	Active	Production	WSON (DRV)   6	250   SMALL T&R	Yes	NIPDAUAG	Level-1-260C-UNLIM	-40 to 125	OEI
<a href="#">TPS71825-12DRVR</a>	Active	Production	WSON (DRV)   6	3000   LARGE T&R	Yes	NIPDAUAG	Level-1-260C-UNLIM	-40 to 125	BVO
TPS71825-12DRVR.B	Active	Production	WSON (DRV)   6	3000   LARGE T&R	Yes	NIPDAUAG	Level-1-260C-UNLIM	-40 to 125	BVO
<a href="#">TPS71825-12DRVT</a>	Active	Production	WSON (DRV)   6	250   SMALL T&R	Yes	NIPDAUAG	Level-1-260C-UNLIM	-40 to 125	BVO
TPS71825-12DRVT.B	Active	Production	WSON (DRV)   6	250   SMALL T&R	Yes	NIPDAUAG	Level-1-260C-UNLIM	-40 to 125	BVO
<a href="#">TPS71828-30DRVR</a>	Active	Production	WSON (DRV)   6	3000   LARGE T&R	Yes	NIPDAUAG	Level-1-260C-UNLIM	-40 to 125	BVX
TPS71828-30DRVR.B	Active	Production	WSON (DRV)   6	3000   LARGE T&R	Yes	NIPDAUAG	Level-1-260C-UNLIM	-40 to 125	BVX
<a href="#">TPS71828-30DRVT</a>	Active	Production	WSON (DRV)   6	250   SMALL T&R	Yes	NIPDAUAG	Level-1-260C-UNLIM	-40 to 125	BVX
TPS71828-30DRVT.B	Active	Production	WSON (DRV)   6	250   SMALL T&R	Yes	NIPDAUAG	Level-1-260C-UNLIM	-40 to 125	BVX
<a href="#">TPS71913-28DRVR</a>	Active	Production	WSON (DRV)   6	3000   LARGE T&R	Yes	NIPDAUAG	Level-1-260C-UNLIM	-40 to 125	BWP
TPS71913-28DRVR.B	Active	Production	WSON (DRV)   6	3000   LARGE T&R	Yes	NIPDAUAG	Level-1-260C-UNLIM	-40 to 125	BWP
<a href="#">TPS71913-28DRVT</a>	Active	Production	WSON (DRV)   6	250   SMALL T&R	Yes	NIPDAUAG	Level-1-260C-UNLIM	-40 to 125	BWP
TPS71913-28DRVT.B	Active	Production	WSON (DRV)   6	250   SMALL T&R	Yes	NIPDAUAG	Level-1-260C-UNLIM	-40 to 125	BWP
<a href="#">TPS71918-12DRVR</a>	Active	Production	WSON (DRV)   6	3000   LARGE T&R	Yes	NIPDAUAG	Level-1-260C-UNLIM	-40 to 125	BWW
TPS71918-12DRVR.B	Active	Production	WSON (DRV)   6	3000   LARGE T&R	Yes	NIPDAUAG	Level-1-260C-UNLIM	-40 to 125	BWW
<a href="#">TPS71918-12DRVT</a>	Active	Production	WSON (DRV)   6	250   SMALL T&R	Yes	NIPDAUAG	Level-1-260C-UNLIM	-40 to 125	BWW
TPS71918-12DRVT.B	Active	Production	WSON (DRV)   6	250   SMALL T&R	Yes	NIPDAUAG	Level-1-260C-UNLIM	-40 to 125	BWW
<a href="#">TPS71918-28DRVR</a>	Active	Production	WSON (DRV)   6	3000   LARGE T&R	Yes	NIPDAUAG	Level-1-260C-UNLIM	-40 to 125	ODQ
TPS71918-28DRVR.B	Active	Production	WSON (DRV)   6	3000   LARGE T&R	Yes	NIPDAUAG	Level-1-260C-UNLIM	-40 to 125	ODQ
<a href="#">TPS71918-28DRVT</a>	Active	Production	WSON (DRV)   6	250   SMALL T&R	Yes	NIPDAUAG	Level-1-260C-UNLIM	-40 to 125	ODQ
TPS71918-28DRVT.B	Active	Production	WSON (DRV)   6	250   SMALL T&R	Yes	NIPDAUAG	Level-1-260C-UNLIM	-40 to 125	ODQ
<a href="#">TPS71921-22DRVR</a>	Active	Production	WSON (DRV)   6	3000   LARGE T&R	Yes	NIPDAUAG	Level-1-260C-UNLIM	-40 to 125	OBW

Orderable part number	Status (1)	Material type (2)	Package   Pins	Package qty   Carrier	RoHS (3)	Lead finish/ Ball material (4)	MSL rating/ Peak reflow (5)	Op temp (°C)	Part marking (6)
TPS71921-22DRVR.B	Active	Production	WSON (DRV)   6	3000   LARGE T&R	Yes	NIPDAUAG	Level-1-260C-UNLIM	-40 to 125	OBW
<a href="#">TPS71921-22DRV</a>	Active	Production	WSON (DRV)   6	250   SMALL T&R	Yes	NIPDAUAG	Level-1-260C-UNLIM	-40 to 125	OBW
TPS71921-22DRVT.B	Active	Production	WSON (DRV)   6	250   SMALL T&R	Yes	NIPDAUAG	Level-1-260C-UNLIM	-40 to 125	OBW
<a href="#">TPS71928-28DRVR</a>	Active	Production	WSON (DRV)   6	3000   LARGE T&R	Yes	NIPDAUAG	Level-1-260C-UNLIM	-40 to 125	CAK
TPS71928-28DRVR.B	Active	Production	WSON (DRV)   6	3000   LARGE T&R	Yes	NIPDAUAG	Level-1-260C-UNLIM	-40 to 125	CAK
<a href="#">TPS71928-28DRV</a>	Active	Production	WSON (DRV)   6	250   SMALL T&R	Yes	NIPDAUAG	Level-1-260C-UNLIM	-40 to 125	CAK
TPS71928-28DRVT.B	Active	Production	WSON (DRV)   6	250   SMALL T&R	Yes	NIPDAUAG	Level-1-260C-UNLIM	-40 to 125	CAK
<a href="#">TPS719285-285DRVR</a>	Active	Production	WSON (DRV)   6	3000   LARGE T&R	Yes	NIPDAUAG	Level-1-260C-UNLIM	-40 to 125	OAU
TPS719285-285DRVR.B	Active	Production	WSON (DRV)   6	3000   LARGE T&R	Yes	NIPDAUAG	Level-1-260C-UNLIM	-40 to 125	OAU
<a href="#">TPS71933-28DRVR</a>	Active	Production	WSON (DRV)   6	3000   LARGE T&R	Yes	NIPDAUAG	Level-1-260C-UNLIM	-40 to 125	CAH
TPS71933-28DRVR.B	Active	Production	WSON (DRV)   6	3000   LARGE T&R	Yes	NIPDAUAG	Level-1-260C-UNLIM	-40 to 125	CAH
<a href="#">TPS71933-28DRV</a>	Active	Production	WSON (DRV)   6	250   SMALL T&R	Yes	NIPDAUAG	Level-1-260C-UNLIM	-40 to 125	CAH
TPS71933-28DRVT.B	Active	Production	WSON (DRV)   6	250   SMALL T&R	Yes	NIPDAUAG	Level-1-260C-UNLIM	-40 to 125	CAH
<a href="#">TPS71933-33DRVR</a>	Active	Production	WSON (DRV)   6	3000   LARGE T&R	Yes	NIPDAUAG	Level-1-260C-UNLIM	-40 to 125	BWL
TPS71933-33DRVR.B	Active	Production	WSON (DRV)   6	3000   LARGE T&R	Yes	NIPDAUAG	Level-1-260C-UNLIM	-40 to 125	BWL
<a href="#">TPS71933-33DRV</a>	Active	Production	WSON (DRV)   6	250   SMALL T&R	Yes	NIPDAUAG	Level-1-260C-UNLIM	-40 to 125	BWL
TPS71933-33DRVT.B	Active	Production	WSON (DRV)   6	250   SMALL T&R	Yes	NIPDAUAG	Level-1-260C-UNLIM	-40 to 125	BWL
<a href="#">TPS71936-315DRVR</a>	Active	Production	WSON (DRV)   6	3000   LARGE T&R	Yes	NIPDAUAG	Level-1-260C-UNLIM	-40 to 125	CVZ
TPS71936-315DRVR.B	Active	Production	WSON (DRV)   6	3000   LARGE T&R	Yes	NIPDAUAG	Level-1-260C-UNLIM	-40 to 125	CVZ

(1) **Status:** For more details on status, see our [product life cycle](#).

(2) **Material type:** When designated, preproduction parts are prototypes/experimental devices, and are not yet approved or released for full production. Testing and final process, including without limitation quality assurance, reliability performance testing, and/or process qualification, may not yet be complete, and this item is subject to further changes or possible discontinuation. If available for ordering, purchases will be subject to an additional waiver at checkout, and are intended for early internal evaluation purposes only. These items are sold without warranties of any kind.

(3) **RoHS values:** Yes, No, RoHS Exempt. See the [TI RoHS Statement](#) for additional information and value definition.

(4) **Lead finish/Ball material:** Parts may have multiple material finish options. Finish options are separated by a vertical ruled line. Lead finish/Ball material values may wrap to two lines if the finish value exceeds the maximum column width.

(5) **MSL rating/Peak reflow:** The moisture sensitivity level ratings and peak solder (reflow) temperatures. In the event that a part has multiple moisture sensitivity ratings, only the lowest level per JEDEC standards is shown. Refer to the shipping label for the actual reflow temperature that will be used to mount the part to the printed circuit board.

(6) **Part marking:** There may be an additional marking, which relates to the logo, the lot trace code information, or the environmental category of the part.

Multiple part markings will be inside parentheses. Only one part marking contained in parentheses and separated by a "~" will appear on a part. If a line is indented then it is a continuation of the previous line and the two combined represent the entire part marking for that device.

**Important Information and Disclaimer:**The information provided on this page represents TI's knowledge and belief as of the date that it is provided. TI bases its knowledge and belief on information provided by third parties, and makes no representation or warranty as to the accuracy of such information. Efforts are underway to better integrate information from third parties. TI has taken and continues to take reasonable steps to provide representative and accurate information but may not have conducted destructive testing or chemical analysis on incoming materials and chemicals. TI and TI suppliers consider certain information to be proprietary, and thus CAS numbers and other limited information may not be available for release.

In no event shall TI's liability arising out of such information exceed the total purchase price of the TI part(s) at issue in this document sold by TI to Customer on an annual basis.

## TAPE AND REEL INFORMATION



### QUADRANT ASSIGNMENTS FOR PIN 1 ORIENTATION IN TAPE



\*All dimensions are nominal

Device	Package Type	Package Drawing	Pins	SPQ	Reel Diameter (mm)	Reel Width W1 (mm)	A0 (mm)	B0 (mm)	K0 (mm)	P1 (mm)	W (mm)	Pin1 Quadrant
TPS71812-33DRVR	WSO	DRV	6	3000	179.0	8.4	2.2	2.2	1.2	4.0	8.0	Q2
TPS71812-33DRVT	WSO	DRV	6	250	179.0	8.4	2.2	2.2	1.2	4.0	8.0	Q2
TPS71818-33DRVR	WSO	DRV	6	3000	178.0	8.4	2.25	2.25	1.0	4.0	8.0	Q2
TPS71818-33DRVT	WSO	DRV	6	250	178.0	8.4	2.25	2.25	1.0	4.0	8.0	Q2
TPS71825-12DRVR	WSO	DRV	6	3000	179.0	8.4	2.2	2.2	1.2	4.0	8.0	Q2
TPS71825-12DRVT	WSO	DRV	6	250	179.0	8.4	2.2	2.2	1.2	4.0	8.0	Q2
TPS71828-30DRVR	WSO	DRV	6	3000	179.0	8.4	2.2	2.2	1.2	4.0	8.0	Q2
TPS71828-30DRVT	WSO	DRV	6	250	179.0	8.4	2.2	2.2	1.2	4.0	8.0	Q2
TPS71913-28DRVR	WSO	DRV	6	3000	179.0	8.4	2.2	2.2	1.2	4.0	8.0	Q2
TPS71913-28DRVT	WSO	DRV	6	250	179.0	8.4	2.2	2.2	1.2	4.0	8.0	Q2
TPS71918-12DRVR	WSO	DRV	6	3000	179.0	8.4	2.2	2.2	1.2	4.0	8.0	Q2
TPS71918-12DRVT	WSO	DRV	6	250	179.0	8.4	2.2	2.2	1.2	4.0	8.0	Q2
TPS71918-28DRVR	WSO	DRV	6	3000	178.0	8.4	2.25	2.25	1.0	4.0	8.0	Q2
TPS71918-28DRVT	WSO	DRV	6	250	178.0	8.4	2.25	2.25	1.0	4.0	8.0	Q2
TPS71921-22DRVR	WSO	DRV	6	3000	179.0	8.4	2.2	2.2	1.2	4.0	8.0	Q2
TPS71921-22DRVT	WSO	DRV	6	250	179.0	8.4	2.2	2.2	1.2	4.0	8.0	Q2

Device	Package Type	Package Drawing	Pins	SPQ	Reel Diameter (mm)	Reel Width W1 (mm)	A0 (mm)	B0 (mm)	K0 (mm)	P1 (mm)	W (mm)	Pin1 Quadrant
TPS71928-28DRVR	WSON	DRV	6	3000	179.0	8.4	2.2	2.2	1.2	4.0	8.0	Q2
TPS71928-28DRVT	WSON	DRV	6	250	179.0	8.4	2.2	2.2	1.2	4.0	8.0	Q2
TPS719285-285DRVR	WSON	DRV	6	3000	179.0	8.4	2.2	2.2	1.2	4.0	8.0	Q2
TPS71933-28DRVR	WSON	DRV	6	3000	179.0	8.4	2.2	2.2	1.2	4.0	8.0	Q2
TPS71933-28DRVT	WSON	DRV	6	250	179.0	8.4	2.2	2.2	1.2	4.0	8.0	Q2
TPS71933-33DRVR	WSON	DRV	6	3000	179.0	8.4	2.2	2.2	1.2	4.0	8.0	Q2
TPS71933-33DRVT	WSON	DRV	6	250	179.0	8.4	2.2	2.2	1.2	4.0	8.0	Q2
TPS71936-315DRVR	WSON	DRV	6	3000	179.0	8.4	2.2	2.2	1.2	4.0	8.0	Q2

**TAPE AND REEL BOX DIMENSIONS**

\*All dimensions are nominal

Device	Package Type	Package Drawing	Pins	SPQ	Length (mm)	Width (mm)	Height (mm)
TPS71812-33DRVR	WSON	DRV	6	3000	200.0	183.0	25.0
TPS71812-33DRVT	WSON	DRV	6	250	200.0	183.0	25.0
TPS71818-33DRVR	WSON	DRV	6	3000	205.0	200.0	33.0
TPS71818-33DRVT	WSON	DRV	6	250	205.0	200.0	33.0
TPS71825-12DRVR	WSON	DRV	6	3000	200.0	183.0	25.0
TPS71825-12DRVT	WSON	DRV	6	250	200.0	183.0	25.0
TPS71828-30DRVR	WSON	DRV	6	3000	200.0	183.0	25.0
TPS71828-30DRVT	WSON	DRV	6	250	203.0	203.0	35.0
TPS71913-28DRVR	WSON	DRV	6	3000	203.0	203.0	35.0
TPS71913-28DRVT	WSON	DRV	6	250	200.0	183.0	25.0
TPS71918-12DRVR	WSON	DRV	6	3000	203.0	203.0	35.0
TPS71918-12DRVT	WSON	DRV	6	250	203.0	203.0	35.0
TPS71918-28DRVR	WSON	DRV	6	3000	205.0	200.0	33.0
TPS71918-28DRVT	WSON	DRV	6	250	205.0	200.0	33.0
TPS71921-22DRVR	WSON	DRV	6	3000	203.0	203.0	35.0
TPS71921-22DRVT	WSON	DRV	6	250	200.0	183.0	25.0
TPS71928-28DRVR	WSON	DRV	6	3000	203.0	203.0	35.0
TPS71928-28DRVT	WSON	DRV	6	250	203.0	203.0	35.0

---

Device	Package Type	Package Drawing	Pins	SPQ	Length (mm)	Width (mm)	Height (mm)
TPS719285-285DRVR	WSON	DRV	6	3000	203.0	203.0	35.0
TPS71933-28DRVR	WSON	DRV	6	3000	200.0	183.0	25.0
TPS71933-28DRVT	WSON	DRV	6	250	203.0	203.0	35.0
TPS71933-33DRVR	WSON	DRV	6	3000	200.0	183.0	25.0
TPS71933-33DRVT	WSON	DRV	6	250	203.0	203.0	35.0
TPS71936-315DRVR	WSON	DRV	6	3000	203.0	203.0	35.0

## GENERIC PACKAGE VIEW

DRV 6

WSON - 0.8 mm max height

PLASTIC SMALL OUTLINE - NO LEAD

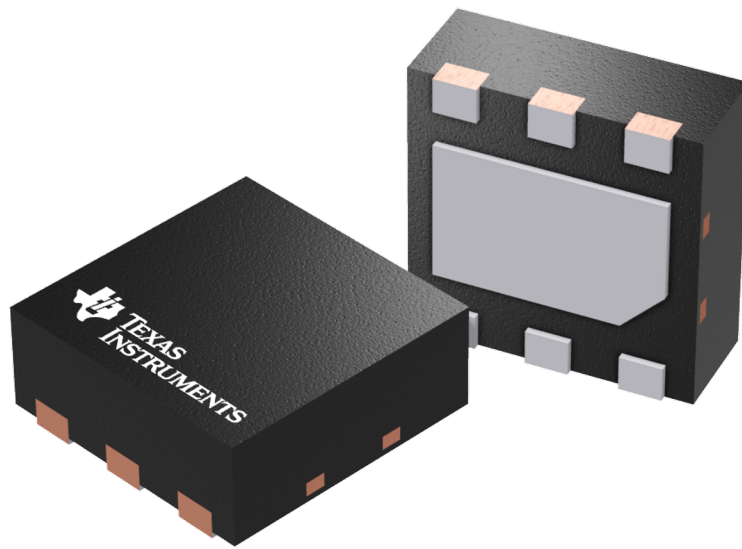

Images above are just a representation of the package family, actual package may vary.  
Refer to the product data sheet for package details.

4206925/F

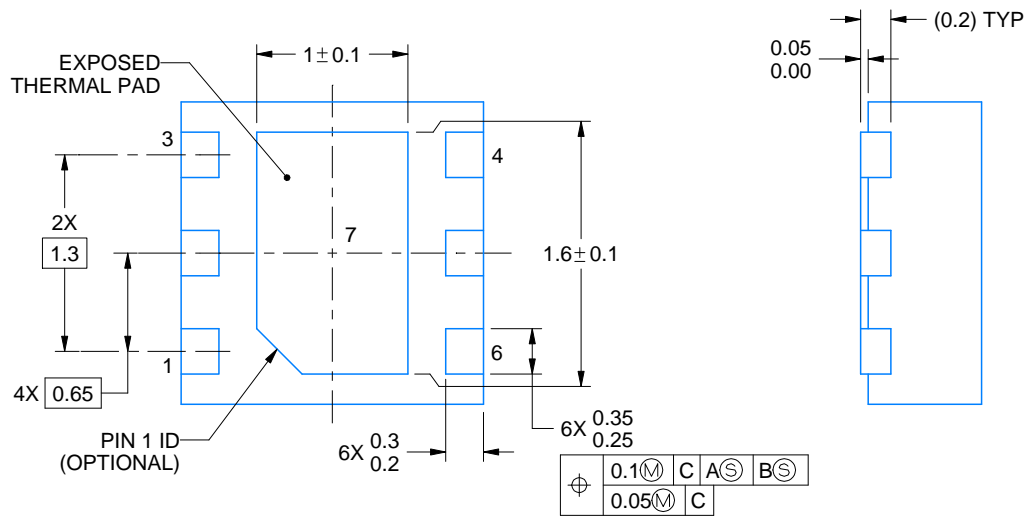
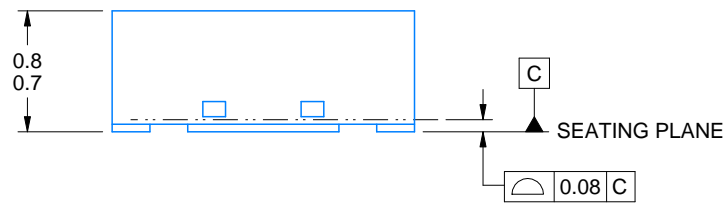
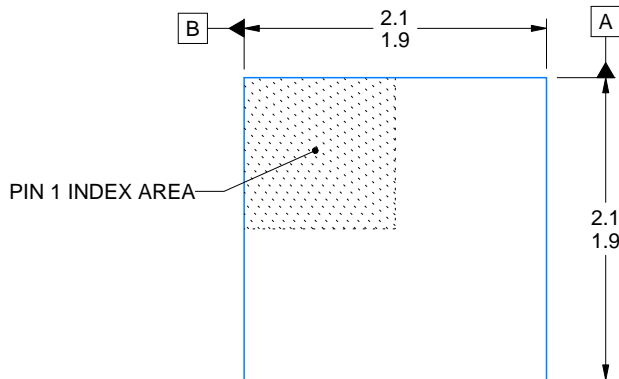
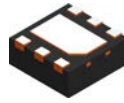

4222173/B 04/2018

NOTES:

1. All linear dimensions are in millimeters. Any dimensions in parenthesis are for reference only. Dimensioning and tolerancing per ASME Y14.5M.
2. This drawing is subject to change without notice.
3. The package thermal pad must be soldered to the printed circuit board for thermal and mechanical performance.



# EXAMPLE STENCIL DESIGN

DRV0006A

WSON - 0.8 mm max height

PLASTIC SMALL OUTLINE - NO LEAD

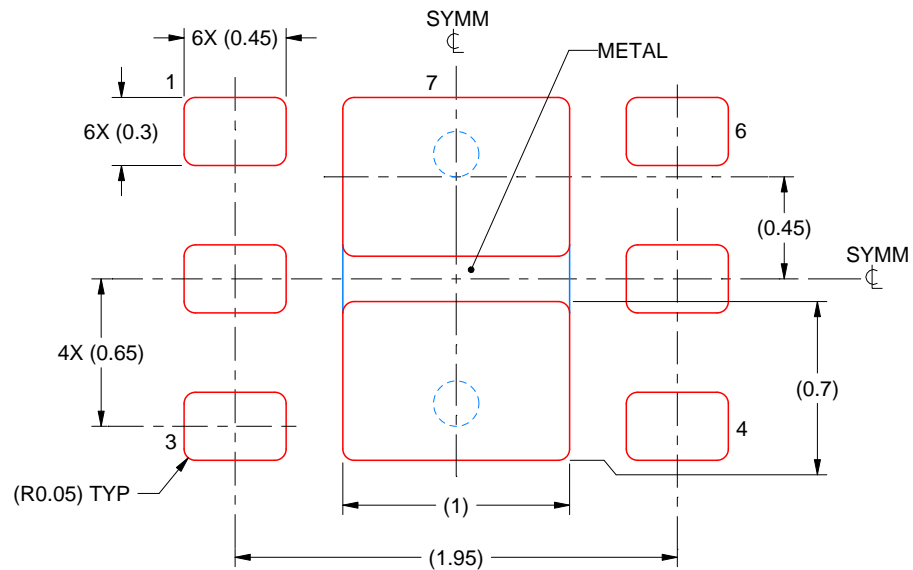

SOLDER PASTE EXAMPLE  
BASED ON 0.125 mm THICK STENCIL

EXPOSED PAD #7  
88% PRINTED SOLDER COVERAGE BY AREA UNDER PACKAGE  
SCALE:30X

4222173/B 04/2018

NOTES: (continued)

6. Laser cutting apertures with trapezoidal walls and rounded corners may offer better paste release. IPC-7525 may have alternate design recommendations.

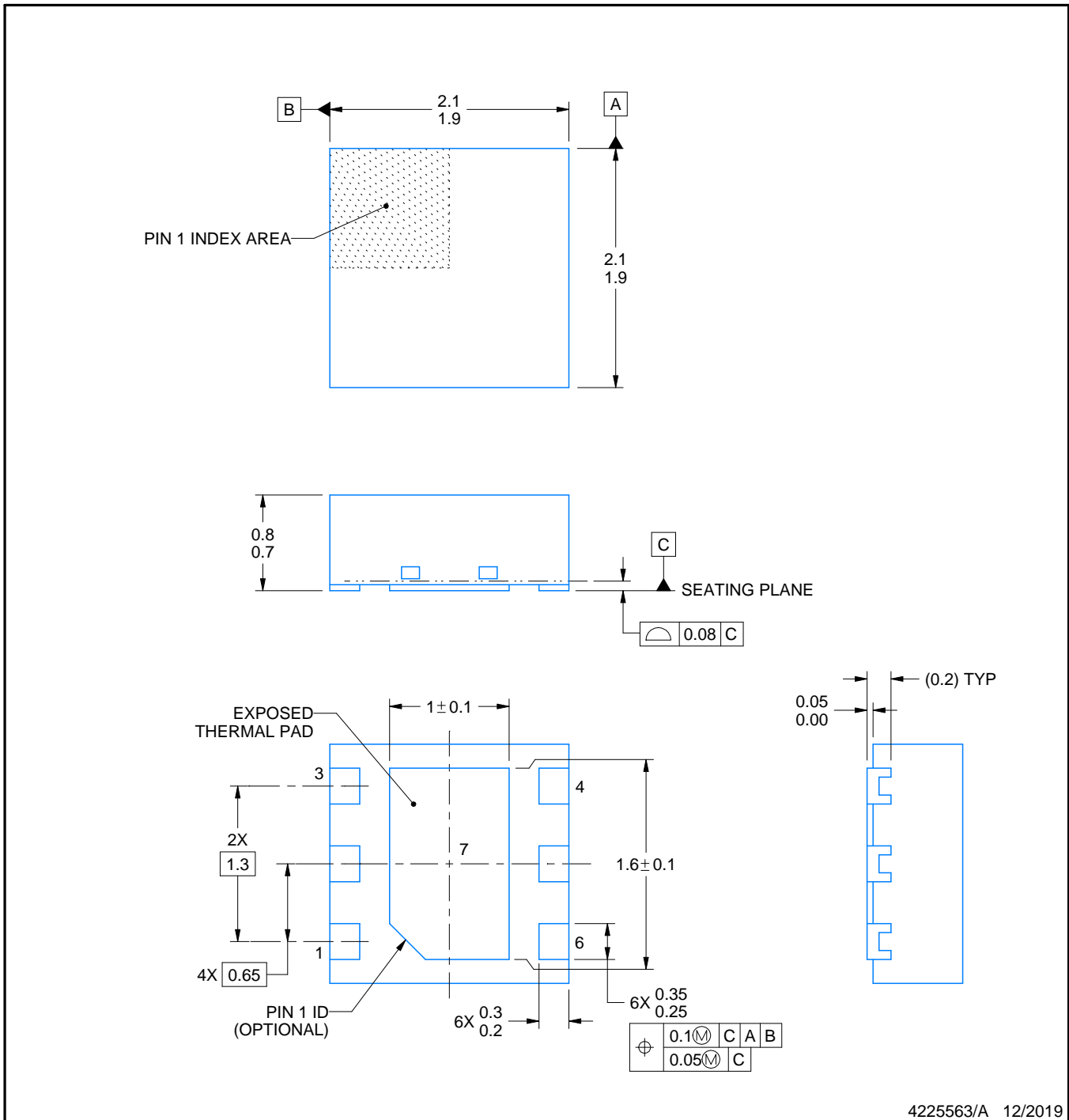
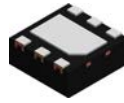

4225563/A 12/2019

NOTES:

1. All linear dimensions are in millimeters. Any dimensions in parenthesis are for reference only. Dimensioning and tolerancing per ASME Y14.5M.
2. This drawing is subject to change without notice.
3. The package thermal pad must be soldered to the printed circuit board for thermal and mechanical performance.

# EXAMPLE BOARD LAYOUT

DRV0006D

WSON - 0.8 mm max height

PLASTIC SMALL OUTLINE - NO LEAD

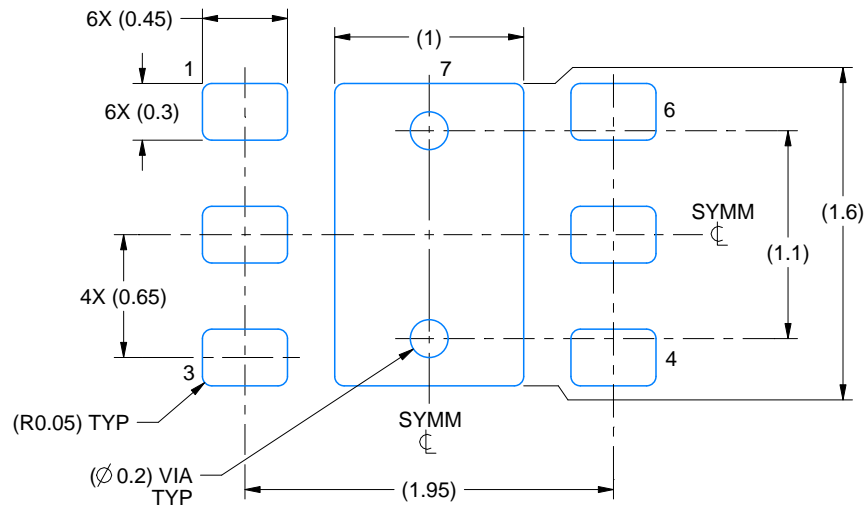

LAND PATTERN EXAMPLE  
EXPOSED METAL SHOWN  
SCALE:25X

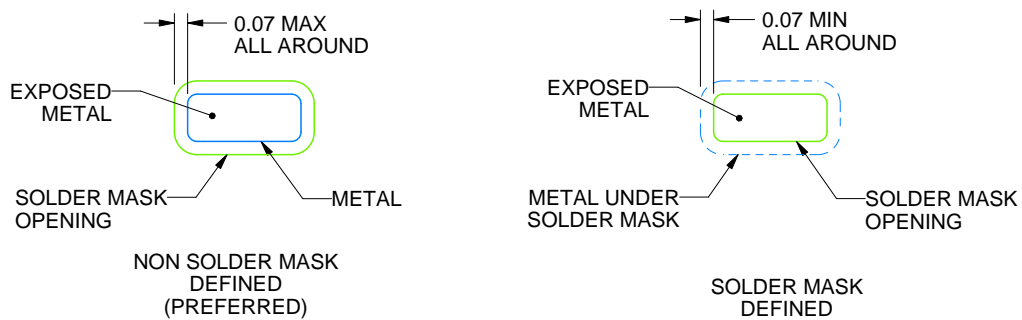

SOLDER MASK DETAILS

4225563/A 12/2019

NOTES: (continued)

4. This package is designed to be soldered to a thermal pad on the board. For more information, see Texas Instruments literature number SLUA271 ([www.ti.com/lit/sluea271](http://www.ti.com/lit/sluea271)).
5. Vias are optional depending on application, refer to device data sheet. If some or all are implemented, recommended via locations are shown.

# EXAMPLE STENCIL DESIGN

DRV0006D

WSON - 0.8 mm max height

PLASTIC SMALL OUTLINE - NO LEAD

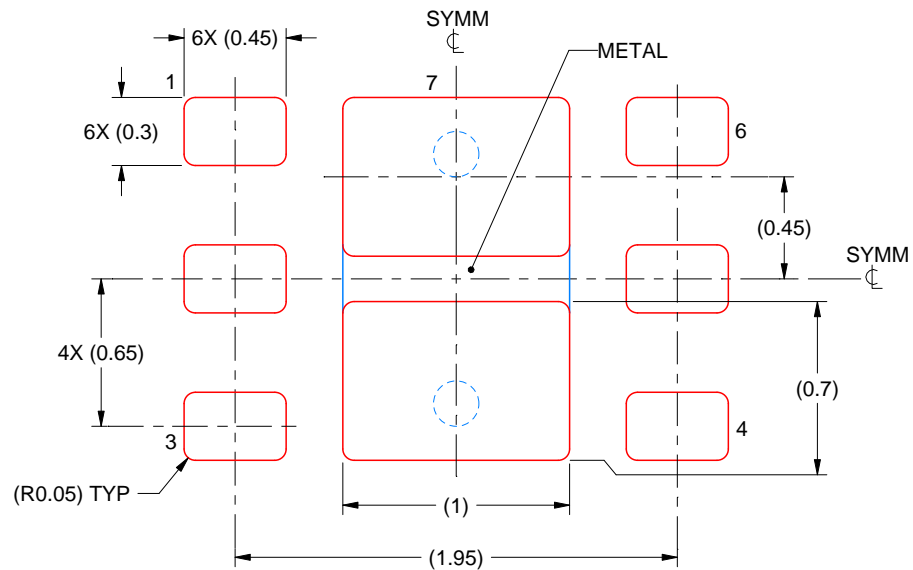

SOLDER PASTE EXAMPLE  
BASED ON 0.125 mm THICK STENCIL

EXPOSED PAD #7  
88% PRINTED SOLDER COVERAGE BY AREA UNDER PACKAGE  
SCALE:30X

4225563/A 12/2019

NOTES: (continued)

6. Laser cutting apertures with trapezoidal walls and rounded corners may offer better paste release. IPC-7525 may have alternate design recommendations.

## IMPORTANT NOTICE AND DISCLAIMER

TI PROVIDES TECHNICAL AND RELIABILITY DATA (INCLUDING DATA SHEETS), DESIGN RESOURCES (INCLUDING REFERENCE DESIGNS), APPLICATION OR OTHER DESIGN ADVICE, WEB TOOLS, SAFETY INFORMATION, AND OTHER RESOURCES "AS IS" AND WITH ALL FAULTS, AND DISCLAIMS ALL WARRANTIES, EXPRESS AND IMPLIED, INCLUDING WITHOUT LIMITATION ANY IMPLIED WARRANTIES OF MERCHANTABILITY, FITNESS FOR A PARTICULAR PURPOSE OR NON-INFRINGEMENT OF THIRD PARTY INTELLECTUAL PROPERTY RIGHTS.

These resources are intended for skilled developers designing with TI products. You are solely responsible for (1) selecting the appropriate TI products for your application, (2) designing, validating and testing your application, and (3) ensuring your application meets applicable standards, and any other safety, security, regulatory or other requirements.

These resources are subject to change without notice. TI grants you permission to use these resources only for development of an application that uses the TI products described in the resource. Other reproduction and display of these resources is prohibited. No license is granted to any other TI intellectual property right or to any third party intellectual property right. TI disclaims responsibility for, and you will fully indemnify TI and its representatives against, any claims, damages, costs, losses, and liabilities arising out of your use of these resources.

TI's products are provided subject to [TI's Terms of Sale](#) or other applicable terms available either on [ti.com](https://www.ti.com) or provided in conjunction with such TI products. TI's provision of these resources does not expand or otherwise alter TI's applicable warranties or warranty disclaimers for TI products.

TI objects to and rejects any additional or different terms you may have proposed.

Mailing Address: Texas Instruments, Post Office Box 655303, Dallas, Texas 75265

Copyright © 2025, Texas Instruments Incorporated