

TA8217P

DUAL AUDIO POWER AMPLIFIER

TA8217P is dual audio power amplifier designed for the audio power amplifier of portable radio cassette tape recorder.

FEATURES

- High Output Power : $P_{out} = 2.5W$ (Typ.)
($V_{CC} = 9V$, $R_L = 4\Omega$, $f = 1kHz$, THD = 10%)
- Soft Clip
- Built-in Thermal Shutdown Protection Circuit
- Wide Operating Supply Voltage Range : $V_{CC} = 4.5 \sim 12V$ ($T_a = 25^\circ C$)

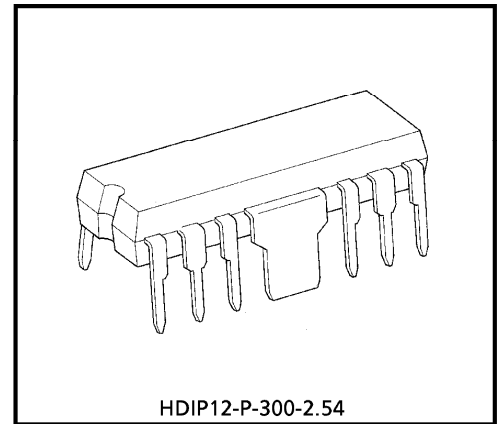

HDIP12-P-300-2.54

Weight : 1.4g (Typ.)

BLOCK DIAGRAM

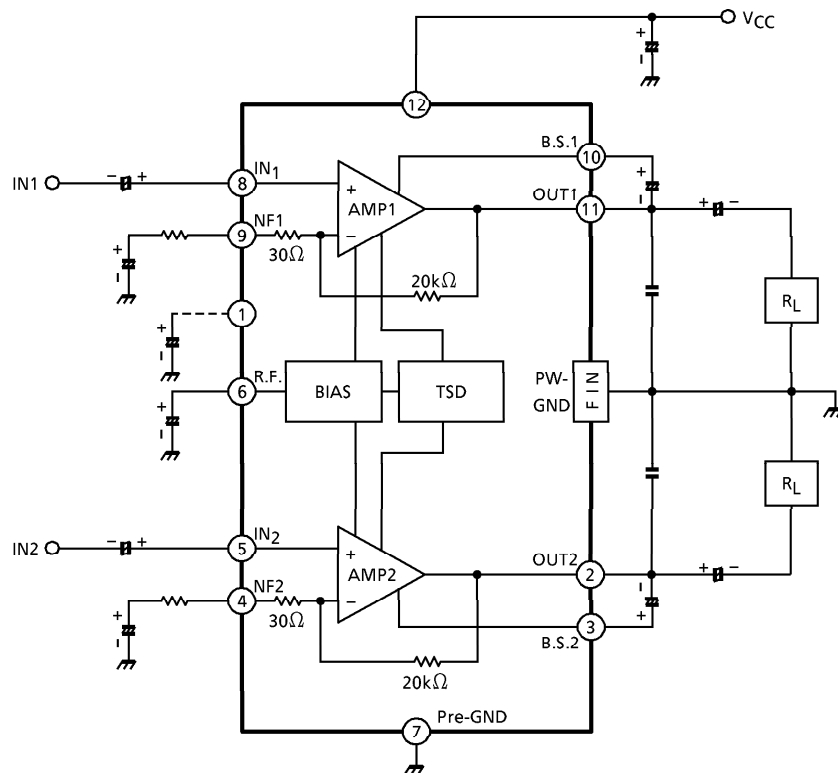

PRECAUTIONS FOR USE AND APPLICATION

(1) Input stage

The input stage of power amplifier is comprised of a PNP differential pair preceded by a PNP emitter follower which allows DC referencing of the source signal to ground. This eliminates the need for an input coupling capacitor. However, in case the brush noise of volume becomes a problem, provide serially a coupling capacitor to the input side.

(2) Adjustment of voltage gain

The voltage gain is fixed at $G_V \cong 56.5\text{dB}$ by the resistors (R_1 and R_2) in IC, however, its reduction is possible through adding R_f as shown in Fig.1. In this case, the voltage gain is obtained by the following equation.

$$G_V \cong 20 \log \frac{R_1 + R_2 + R_f}{R_1 + R_f}$$

It is recommended to use this IC with the voltage gain of $G_V = 40\text{dB}$ or over.

(3) Measures against oscillation

For the capacitors C_6 and C_7 to be applied for preventing the oscillation between output terminal and GND, use the polyester film capacitor having superior quality in high frequency and temperature characteristics, however, since the characteristics of the capacitor may be different depending on the manufactures or kinds, apply the capacitor after confirmation.

Since the characteristics of the capacitor of the ceramic Type are liable to be affected by the temperature and the voltage, use the capacitor of larger capacity and be sure to perform the thermal test to check the oscillation allowance.

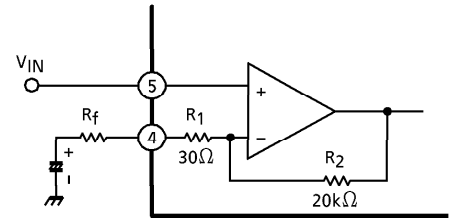

Fig.1

MAXIMUM RATINGS (Ta = 25°C)

CHARACTERISTIC	SYMBOL	RATING	UNIT
Supply Voltage	V _{CC}	20	V
Power Dissipation (Package Limitation)	P _D (Note 1)	4.0	W
Output Current	I _O	2.5	A
Operating Temperature	T _{opr}	-20~75	°C
Storage Temperature	T _{stg}	-55~150	°C

(Note 1) Value for mounting on PC board (Refer to P_D - Ta curve)

ELECTRICAL CHARACTERISTICS

(Unless otherwise specified, V_{CC} = 9V, R_L = 4Ω, R_g = 600Ω, f = 1kHz, Ta = 25°C)

CHARACTERISTIC	SYMBOL	TEST CIRCUIT	TEST CONDITION	MIN.	TYP.	MAX.	UNIT
Quiescent Current	I _{CCQ}	—	V _{in} = 0	—	23	55	mA
Output Power	P _{out} (1)	—	THD = 10%	2.0	2.5	—	W
	P _{out} (2)	—	THD = 10%, R _L = 3Ω	—	2.9	—	
	P _{out} (3)	—	THD = 10%, V _{CC} = 6V	—	1.0	—	
Total Harmonic Distortion	THD	—	P _{out} = 0.4W, G _v = 45dB	—	0.2	1.2	%
Voltage Gain	G _v (1)	—	R _f = 82Ω, V _{out} = 0.775V _{rms} (0dBm)	43	45	47	dB
	G _v (2)	—	R _f = 0, V _{out} = 0.775V _{rms} (0dBm)	—	56	—	
Cross Talk	C.T.	—	R _g = 600Ω, V _{out} = 0.775V _{rms} (0dBm)	—	-60	—	dB
Ripple Rejection Ratio	R.R.	—	R _g = 600Ω, V _{ripple} = 0.245V _{rms} (-10dBm) f _{ripple} = 100Hz	—	-52	-45	dB
Output Noise Voltage	V _{no}	—	R _g = 10kΩ, G _v = 45dB B _W = 20~20kHz	—	0.35	1.0	mV _{rms}
Input Resistance	R _{IN}	—	—	—	30	—	kΩ
Input Offset Voltage	V ₅ , V ₈	—	V _{in} = 0	—	20	—	mV

TYP. DC VOLTAGE OF EACH TERMINAL (V_{CC} = 9V, Ta = 25°C by test circuit)

TERMINAL No.	1	2	3	4	5	6	7	8	9	10	11	12
DC Voltage (V)	8.1	4.5	8.8	0.6	0.02	8.9	0	0.02	0.6	8.8	4.5	9.0

TEST CIRCUIT

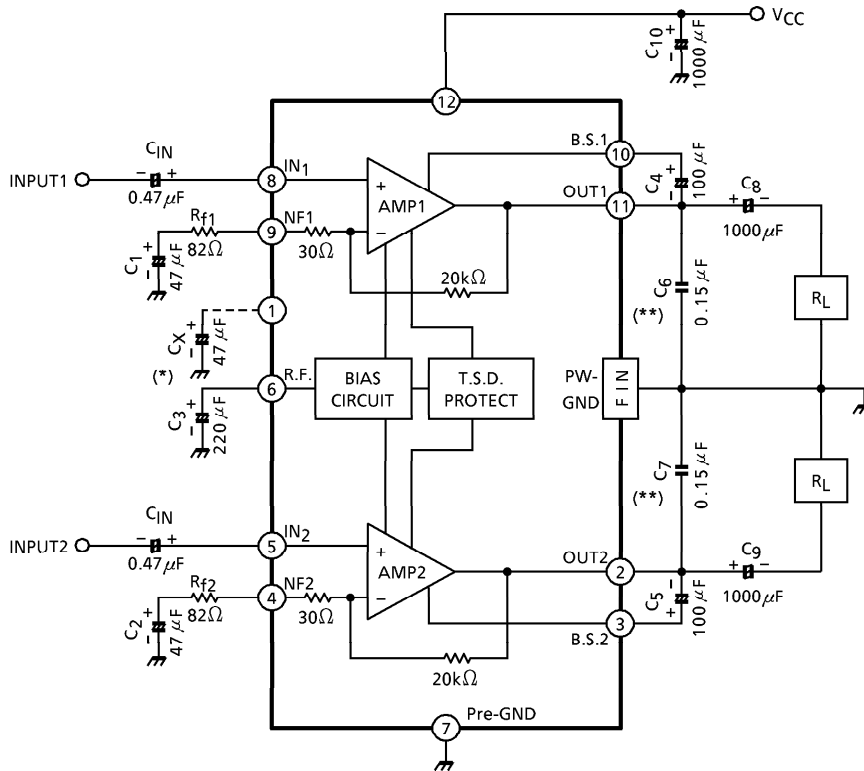

(*) C_X is a ripple filter capacitor for transition duration when supply voltage and pin① voltage are inverted.

(**) For C_6 and C_7 , it is advised to use polyester film capacitor having superior quality in the characteristics of high frequency and temperature.

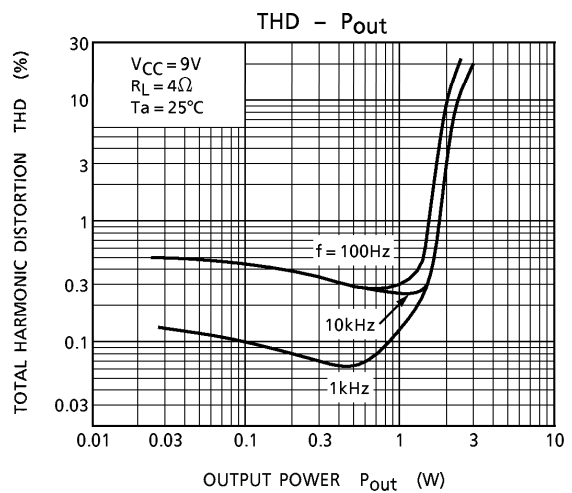
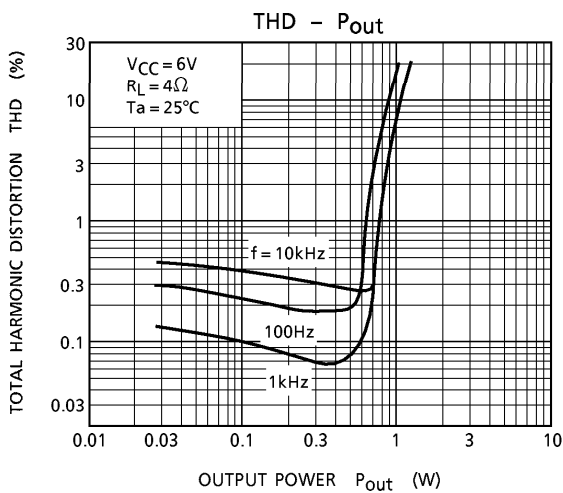
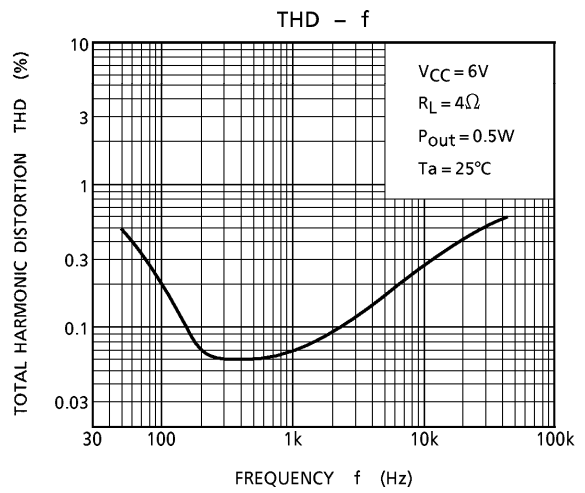
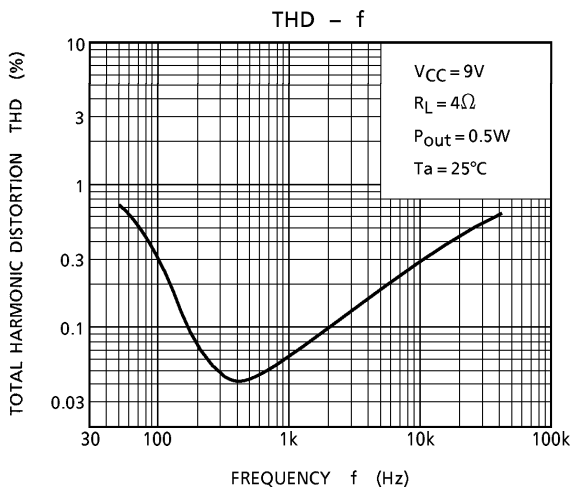
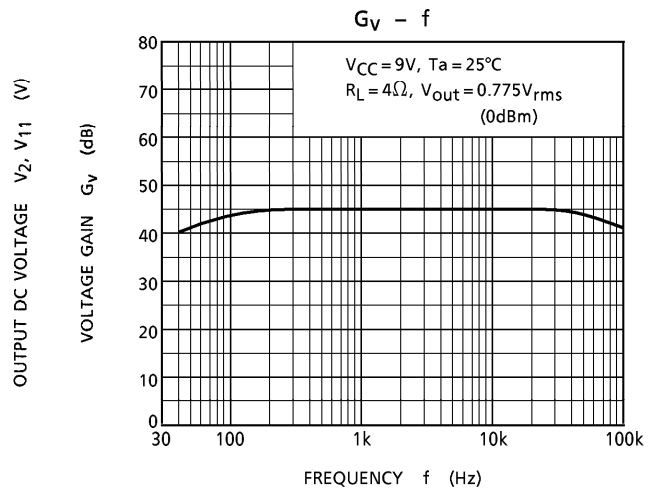
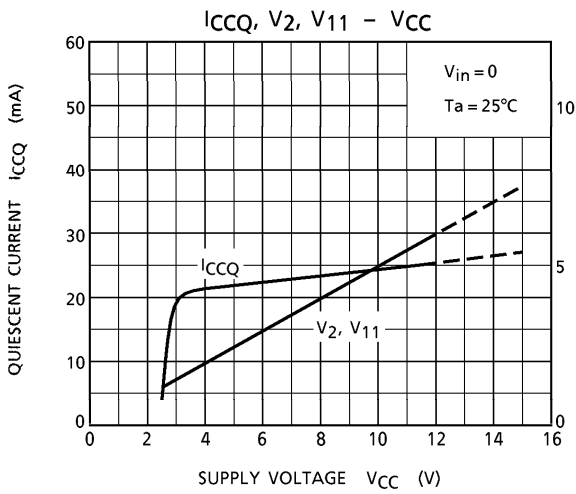

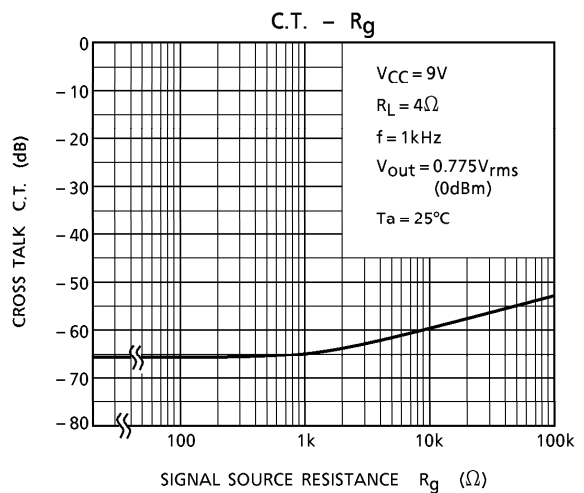
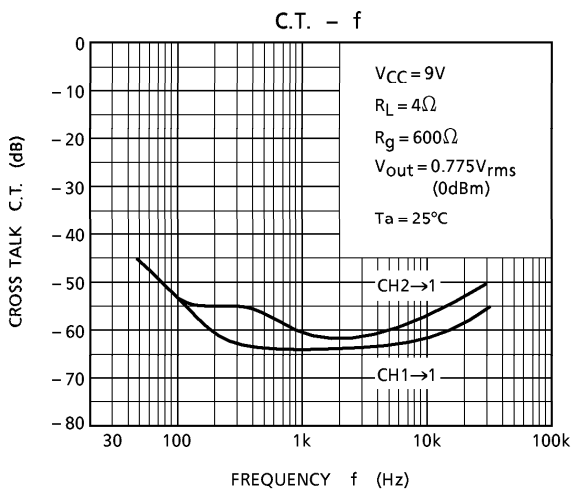
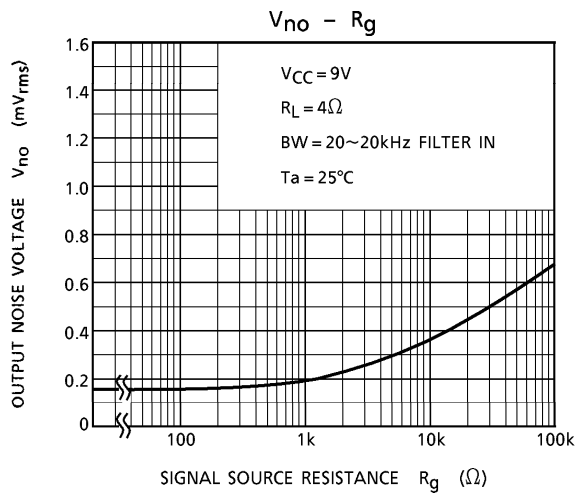
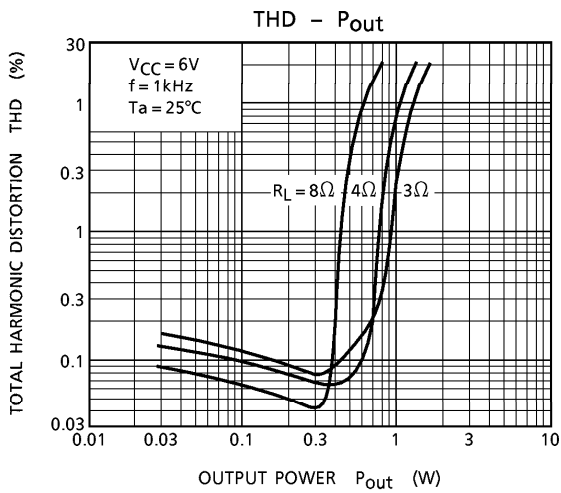
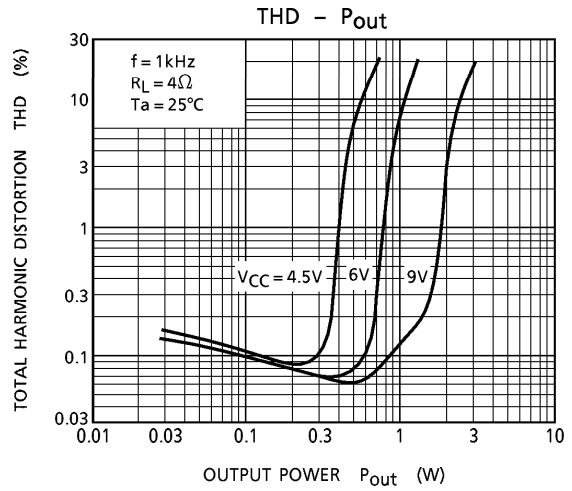
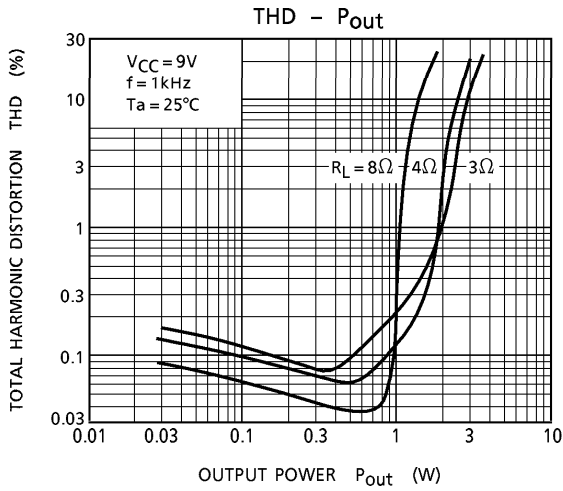

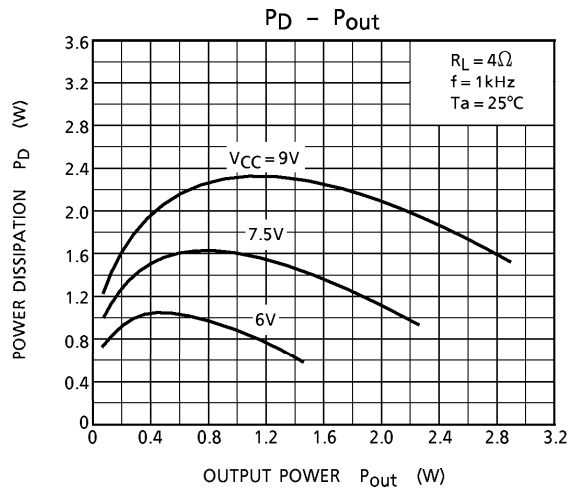
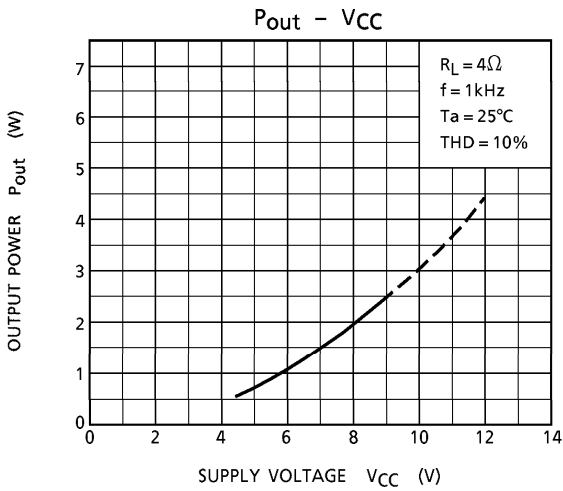
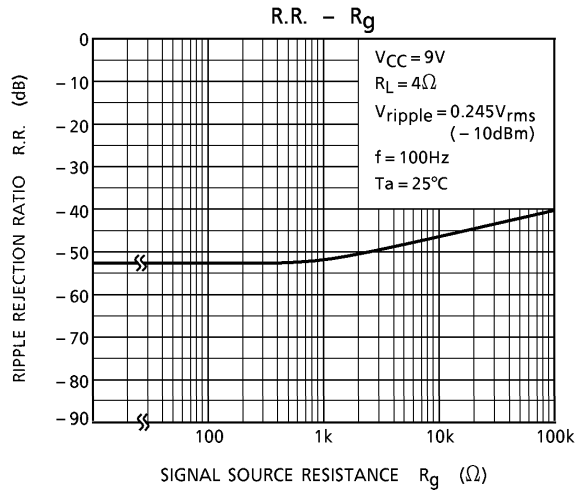
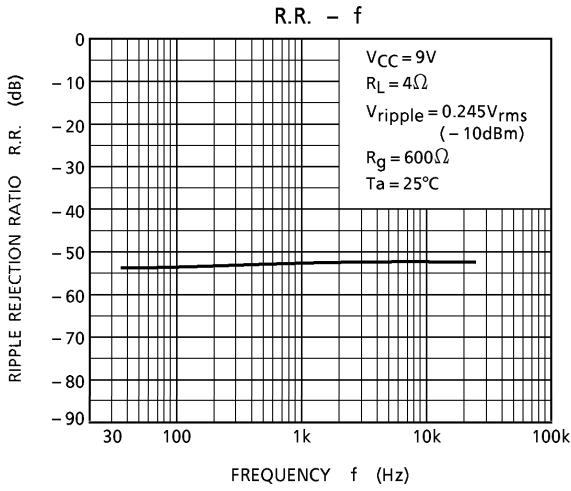

HEAT SINK

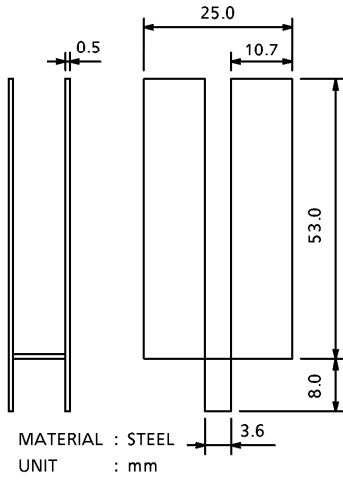

RECOMMENDED PCB LAYOUT

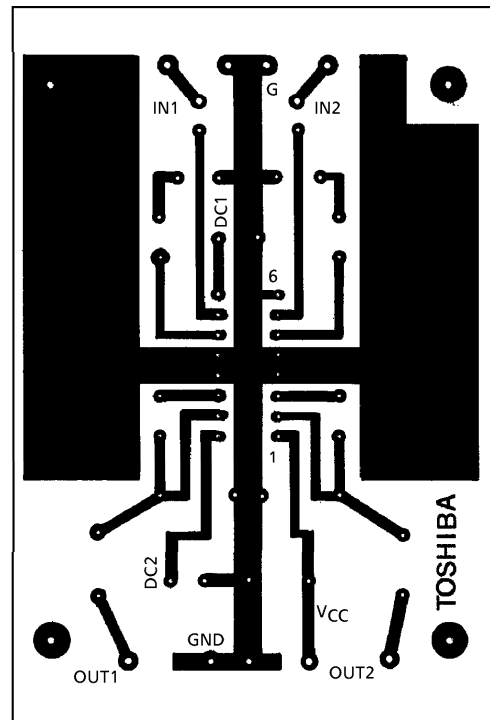

PCB : EPOXY GLASS
80mm x 60mm x 1.2mm

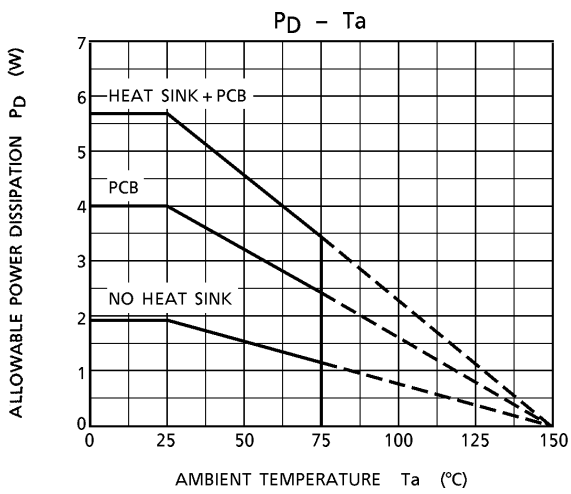

PACKAGE DIMENSIONS
HDIP12-P-300-2.54

Unit : mm

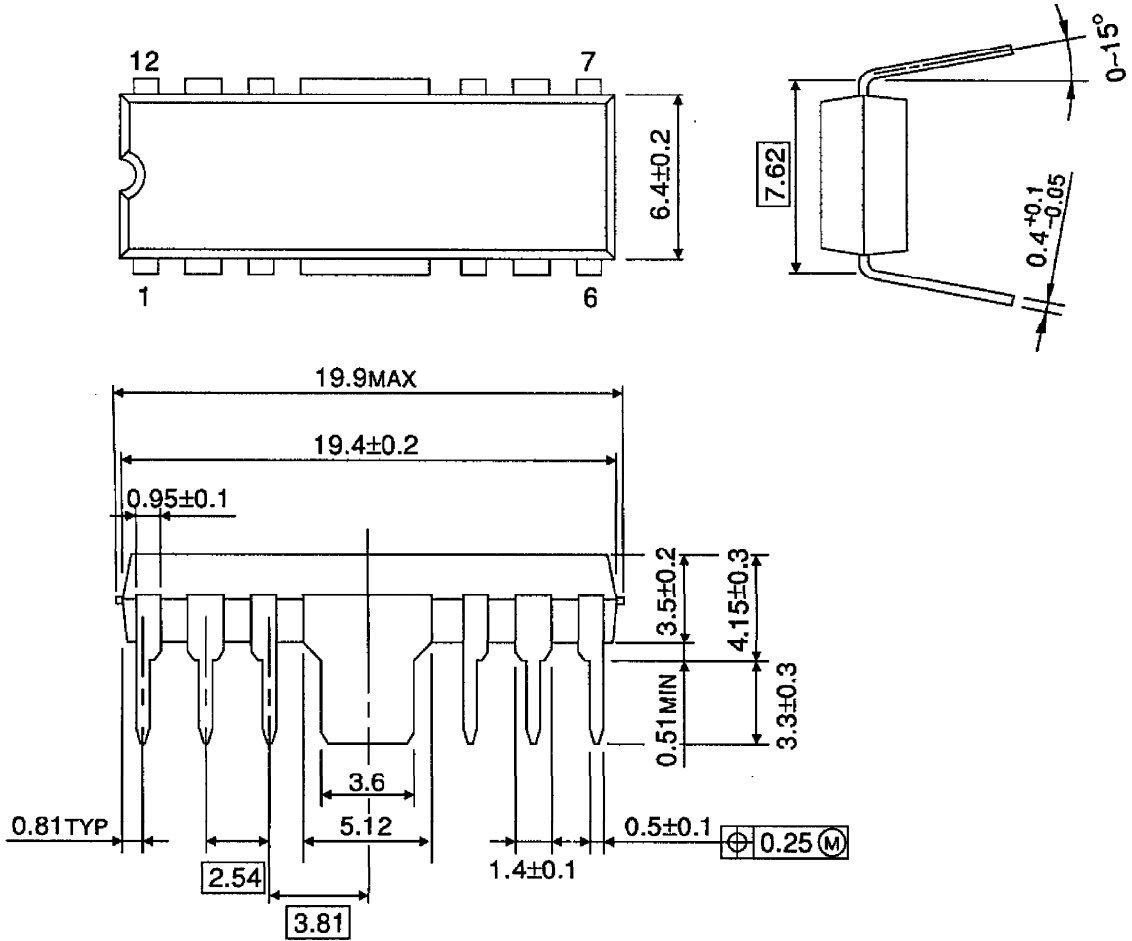

Weight : 1.4g (Typ.)

RESTRICTIONS ON PRODUCT USE

000707EBA

- TOSHIBA is continually working to improve the quality and reliability of its products. Nevertheless, semiconductor devices in general can malfunction or fail due to their inherent electrical sensitivity and vulnerability to physical stress. It is the responsibility of the buyer, when utilizing TOSHIBA products, to comply with the standards of safety in making a safe design for the entire system, and to avoid situations in which a malfunction or failure of such TOSHIBA products could cause loss of human life, bodily injury or damage to property. In developing your designs, please ensure that TOSHIBA products are used within specified operating ranges as set forth in the most recent TOSHIBA products specifications. Also, please keep in mind the precautions and conditions set forth in the "Handling Guide for Semiconductor Devices," or "TOSHIBA Semiconductor Reliability Handbook" etc..
- The TOSHIBA products listed in this document are intended for usage in general electronics applications (computer, personal equipment, office equipment, measuring equipment, industrial robotics, domestic appliances, etc.). These TOSHIBA products are neither intended nor warranted for usage in equipment that requires extraordinarily high quality and/or reliability or a malfunction or failure of which may cause loss of human life or bodily injury ("Unintended Usage"). Unintended Usage include atomic energy control instruments, airplane or spaceship instruments, transportation instruments, traffic signal instruments, combustion control instruments, medical instruments, all types of safety devices, etc.. Unintended Usage of TOSHIBA products listed in this document shall be made at the customer's own risk.
- The products described in this document are subject to the foreign exchange and foreign trade laws.
- The information contained herein is presented only as a guide for the applications of our products. No responsibility is assumed by TOSHIBA CORPORATION for any infringements of intellectual property or other rights of the third parties which may result from its use. No license is granted by implication or otherwise under any intellectual property or other rights of TOSHIBA CORPORATION or others.
- The information contained herein is subject to change without notice.