

TOSHIBA Photocoupler GaAs Ired & Photo-Transistor

TLP331, TLP332

- Office Machine
- Household Use Equipment
- Programmable Controllers
- AC / DC-Input Module
- Telecommunication

The TOSHIBA TLP331 and TLP332 consists of a gallium arsenide infrared emitting diode optically coupled to a photo-transistor in a six lead plastic DIP package.

This photocoupler provides the unique feature of high current transfer ratio at both low output voltage and low input current. This makes it ideal for use in low power logic circuits, telecommunications equipment and portable electronics isolation applications.

TLP332 is no-base internal connection for high-EMI environments.

- Collector-emitter voltage: 55V (min.)
- Isolation voltage: 5000Vrms (min.)
- UL recognized: UL1577, file no. E67349
- Current transfer ratio

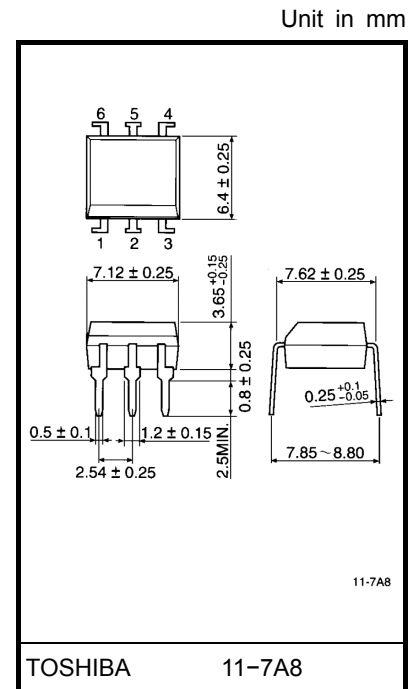

Weight: 0.4 g

Classi- fication (*)	Current Transfer Ratio (min.)			Marking Of Classi- fication
	Ta = 25°C			
	If = 1mA VCE = 0.5V	If = 0.5mA VCE = 1.5V	If = 1mA VCE = 0.5V	
Rank BV	200%	100%	100%	BV
Standard	100%	50%	50%	BV, blank

(*) Ex. Standard: TLP331
Rank BV: TLP331(BV)

(Note) Application type name for certification test,
please use standard product type name, i.e.
TLP331(BV): TLP331

Pin Configurations (top view)

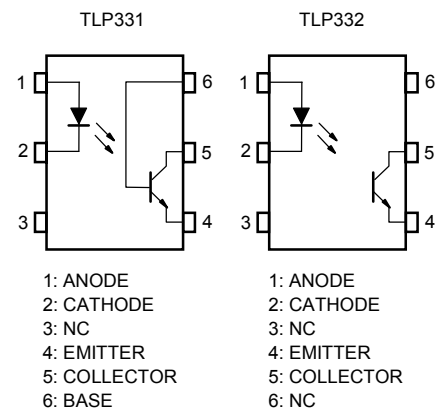

Absolute Maximum Ratings (Ta = 25°C)

Characteristic		Symbol	Rating	Unit
LED	Forward current	I_F	50	mA
	Forward current derating (Ta ≥ 39°C)	$\Delta I_F / ^\circ\text{C}$	-0.7	mA / °C
	Peak forward current (100µs pulse, 100pps)	I_{FP}	1	A
	Reverse Voltage	V_R	5	V
	Junction temperature	T_j	125	°C
Detector	Collector-emitter voltage	V_{CEO}	55	V
	Collector-base voltage (TLP331)	V_{CBO}	80	V
	Emitter-collector voltage	V_{ECO}	7	V
	Emitter-base voltage (TLP331)	V_{EBO}	7	V
	Collector current	I_C	50	mA
	Power dissipation	P_C	150	mW
	Power dissipation derating (Ta ≥ 25°C)	$\Delta P_C / ^\circ\text{C}$	-1.5	mW / °C
	Junction temperature	T_j	125	°C
Storage temperature range		T_{stg}	-55~125	°C
Operating temperature range		T_{opr}	-55~100	°C
Lead soldering temperature (10s)		T_{sol}	260	°C
Total package power dissipation		P_T	250	mW
Total package power dissipation derating (Ta ≥ 25°C)		$P_T / ^\circ\text{C}$	-2.5	mW / °C
Isolation voltage (AC, 1min., RH ≤ 60%) (Note 1)		BV_S	5000	V _{rms}

Note: Using continuously under heavy loads (e.g. the application of high temperature/current/voltage and the significant change in temperature, etc.) may cause this product to decrease in the reliability significantly even if the operating conditions (i.e. operating temperature/current/voltage, etc.) are within the absolute maximum ratings.

Please design the appropriate reliability upon reviewing the Toshiba Semiconductor Reliability Handbook ("Handling Precautions"/"Derating Concept and Methods") and individual reliability data (i.e. reliability test report and estimated failure rate, etc).

(Note 1) Device considered a two terminal device: Pins 1, 2 and 3 shorted together and pins 4, 5 and 6 shorted together.

Recommended Operating Conditions

Characteristic	Symbol	Min.	Typ.	Max.	Unit
Supply voltage	V_{CC}	—	5	25	V
Forward current	I_F	—	1.6	25	mA
Collector current	I_C	—	1	10	mA
Operating temperature	T_{opr}	-25	—	75	°C

Note: Recommended operating conditions are given as a design guideline to obtain expected performance of the device. Additionally, each item is an independent guideline respectively. In developing designs using this product, please confirm specified characteristics shown in this document.

Individual Electrical Characteristics (Ta = 25°C)

Characteristic		Symbol	Test Condition	Min.	Typ.	Max.	Unit
LED	Forward voltage	V_F	$I_F = 10\text{mA}$	1.0	1.15	1.3	V
	Reverse current	I_R	$V_R = 5\text{V}$	—	—	10	μA
	Capacitance	C_T	$V = 0, f = 1\text{MHz}$	—	30	—	pF
Detector	Collector-emitter breakdown voltage	$V_{(BR)CEO}$	$I_C = 0.5\text{mA}$	55	—	—	V
	Emitter-collector breakdown voltage	$V_{(BR)ECO}$	$I_E = 0.1\text{mA}$	7	—	—	V
	Collector-base breakdown voltage (TLP331)	$V_{(BR)CBO}$	$I_C = 0.1\text{mA}$	80	—	—	V
	Emitter-base breakdown voltage (TLP331)	$V_{(BR)EBO}$	$I_E = 0.1\text{mA}$	7	—	—	V
	Collector dark current	I_{CEO}	$V_{CE} = 24\text{V}$	—	10	100	nA
			$V_{CE} = 24\text{V}, T_a = 85^\circ\text{C}$	—	2	50	μA
	Collector dark current (TLP331)	I_{CER}	$V_{CE} = 24\text{V}, T_a = 85^\circ\text{C}$ $R_{BE} = 1\text{M}\Omega$	—	0.5	10	μA
	Collector dark current (TLP331)	I_{CBO}	$V_{CB} = 10\text{V}$	—	0.1	—	nA
	DC forward current gain (TLP331)	h_{FE}	$V_{CE} = 5\text{V}, I_C = 0.5\text{mA}$	—	1000	—	—
	Capacitance (collector to emitter)	C_{CE}	$V = 0, f = 1\text{MHz}$	—	12	—	pF

Coupled Electrical Characteristics (Ta = 25°C)

Characteristic	Symbol	Test Condition	Min.	Typ.	Max.	Unit
Current transfer ratio	I_C / I_F	$I_F = 1\text{mA}, V_{CE} = 0.5\text{V}$ Rank BV	100	—	1200	%
			200	—	1200	
Low input CTR	$I_C / I_{F(\text{low})}$	$I_F = 0.5\text{mA}, V_{CE} = 1.5\text{V}$ Rank BV	50	—	—	%
			100	—	—	
Base photo-current (TLP331)	I_{PB}	$I_F = 1\text{mA}, V_{CB} = 5\text{V}$	—	10	—	μA
Collector-emitter saturation voltage	$V_{CE(\text{sat})}$	$I_C = 0.5\text{mA}, I_F = 1\text{mA}$ $I_C = 1\text{mA}, I_F = 1\text{mA}$ Rank BV	—	—	0.4	V
			—	0.2	—	
			—	—	0.4	

Coupled Electrical Characteristics (Ta = 25~75°C)

Characteristic	Symbol	Test Condition	Min.	Typ.	Max.	Unit
Current transfer ratio	I_C / I_F	$I_F = 1\text{mA}, V_{CE} = 0.5\text{V}$ Rank BV	50	—	—	%
			100	—	—	
Low input CTR	$I_C / I_{F(\text{low})}$	$I_F = 0.5\text{mA}, V_{CE} = 1.5\text{V}$ Rank BV	—	50	—	%
			—	100	—	

Isolation Characteristics (Ta = 25°C)

Characteristic	Symbol	Test Condition	Min.	Typ.	Max.	Unit
Capacitance (input to output)	C _S	V _S = 0, f = 1MHz	—	0.8	—	pF
Isolation resistance	R _S	V = 500V	5×10 ¹⁰	10 ¹⁴	—	Ω
Isolation voltage	BV _S	AC, 1 minute	5000	—	—	V _{rms}
		AC, 1 second, in oil	—	10000	—	
		DC, 1 minute, in oil	—	10000	—	V _{dc}

Switching Characteristics (Ta = 25°C)

Characteristic	Symbol	Test Condition	Min.	Typ.	Max.	Unit
Rise time	t _r	V _{CC} = 10V I _C = 2mA R _L = 100Ω	—	8	—	μs
Fall time	t _f		—	8	—	
Turn-on time	t _{on}		—	10	—	
Turn-off time	t _{off}		—	8	—	
Turn-on time	t _{ON}	R _L = 4.7kΩ (Fig.1) R _{BE} = OPEN V _{CC} = 5V, I _F = 1.6mA	—	10	—	μs
Storage time	t _S		—	50	—	
Turn-off time	t _{OFF}		—	300	—	
Turn-on time	t _{ON}	R _L = 4.7kΩ (Fig.1) R _{BE} = 470kΩ (TLP331) V _{CC} = 5V, I _F = 1.6mA	—	12	—	μs
Storage time	t _S		—	30	—	
Turn-off time	t _{OFF}		—	100	—	

Fig. 1 Switching time test circuit

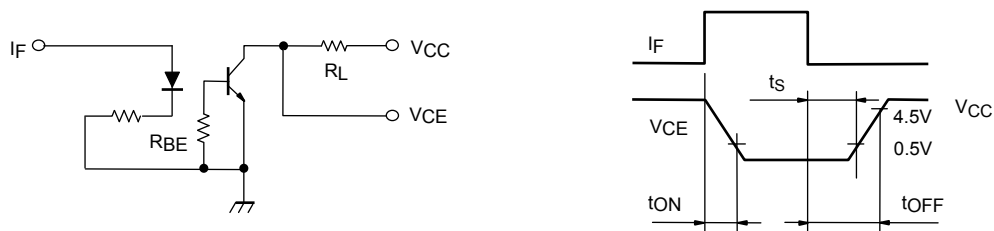

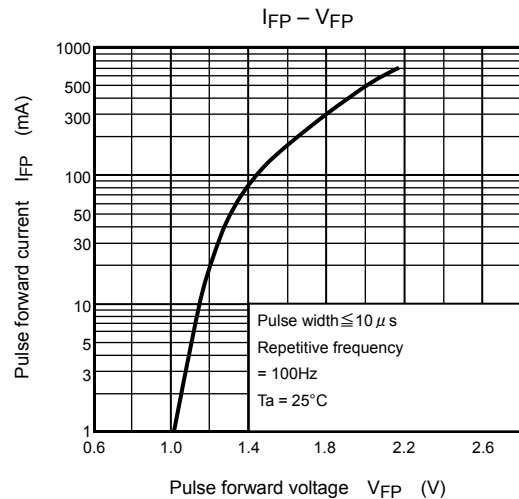
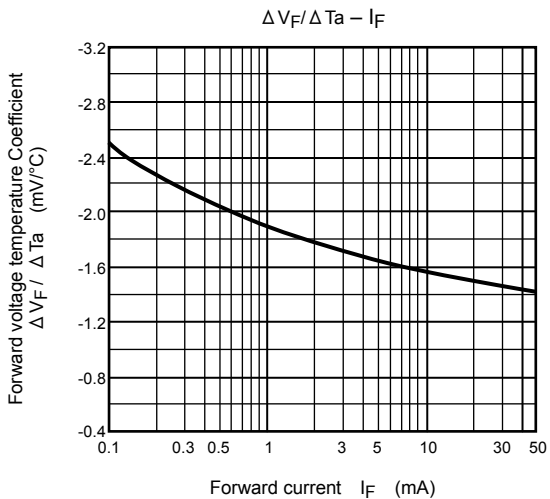
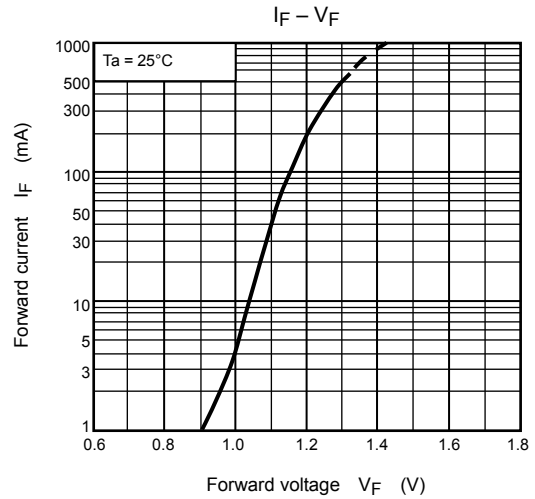
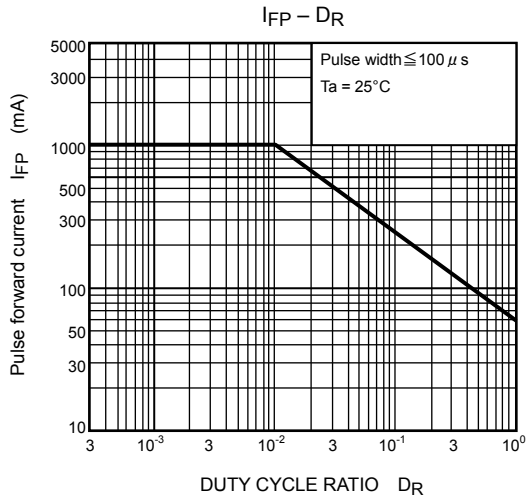
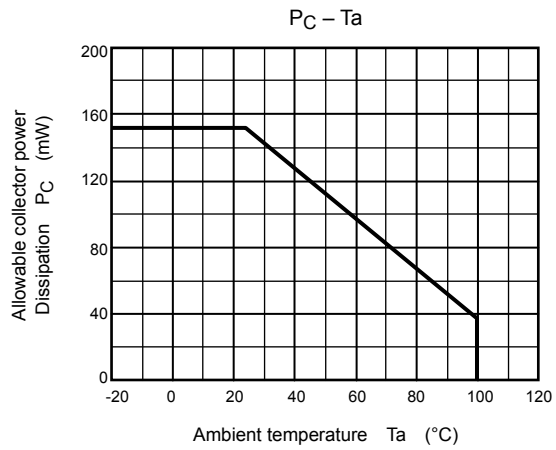
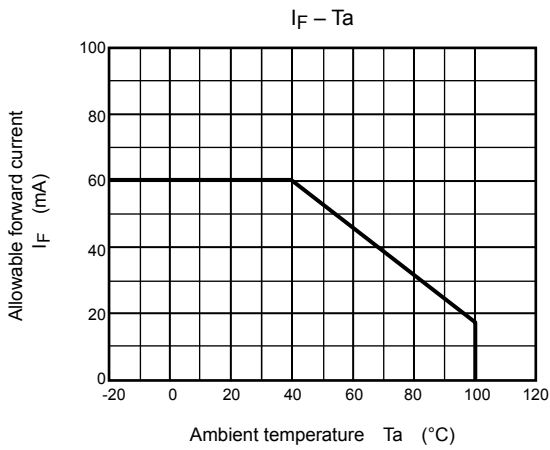

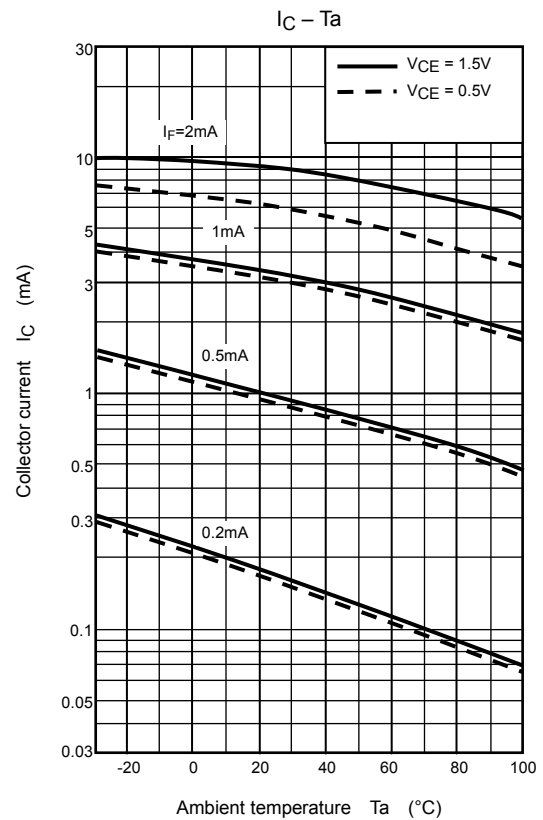
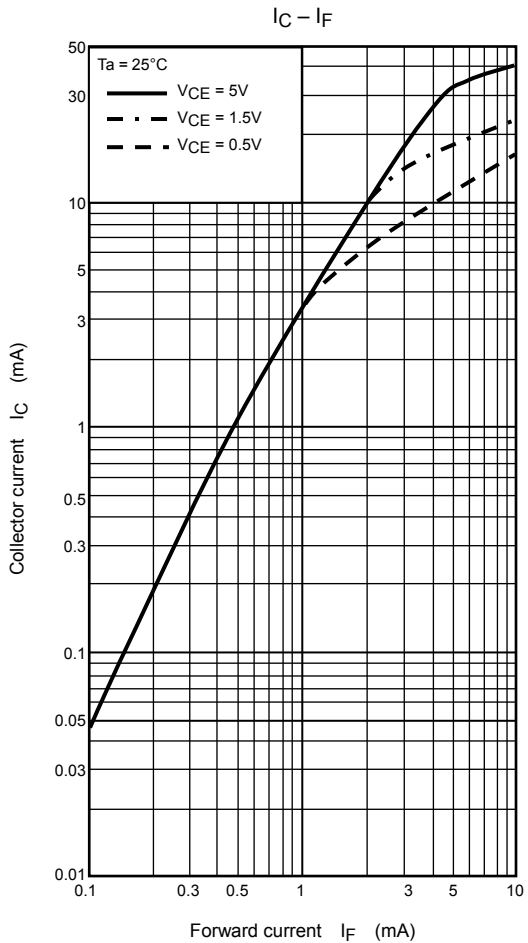
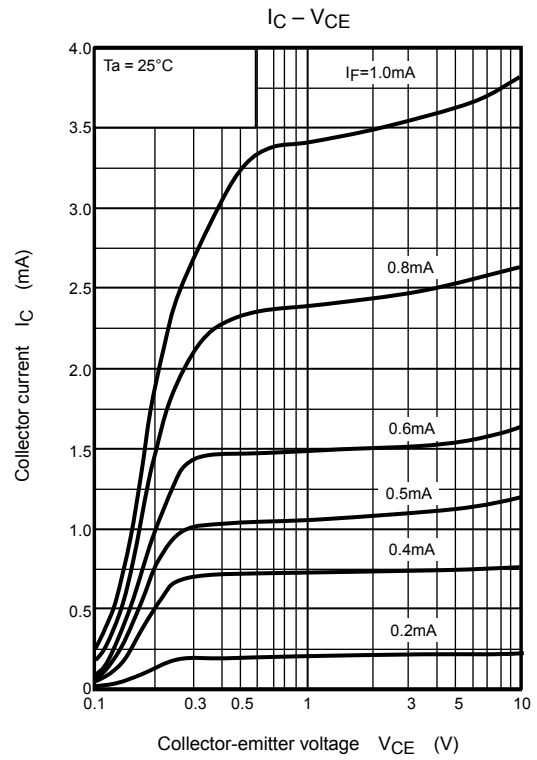
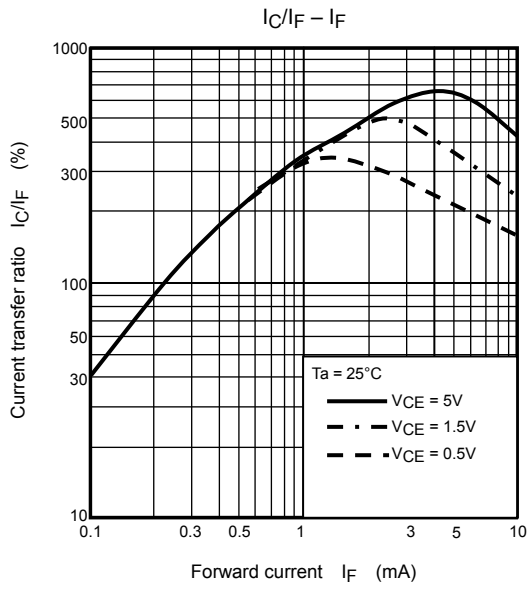

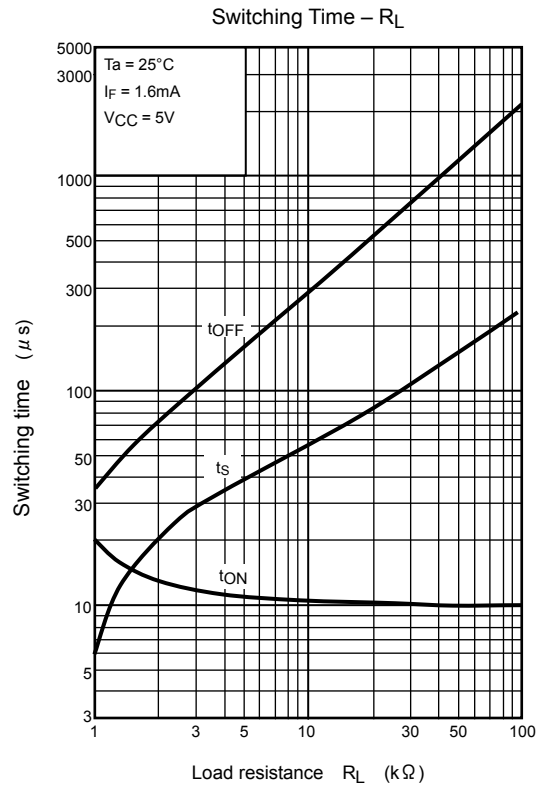
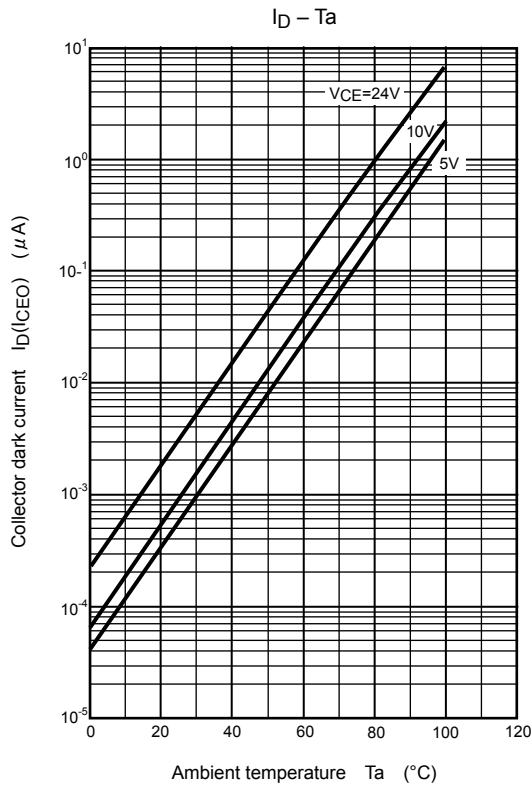

RESTRICTIONS ON PRODUCT USE

20070701-EN

- The information contained herein is subject to change without notice.
- TOSHIBA is continually working to improve the quality and reliability of its products. Nevertheless, semiconductor devices in general can malfunction or fail due to their inherent electrical sensitivity and vulnerability to physical stress. It is the responsibility of the buyer, when utilizing TOSHIBA products, to comply with the standards of safety in making a safe design for the entire system, and to avoid situations in which a malfunction or failure of such TOSHIBA products could cause loss of human life, bodily injury or damage to property.
In developing your designs, please ensure that TOSHIBA products are used within specified operating ranges as set forth in the most recent TOSHIBA products specifications. Also, please keep in mind the precautions and conditions set forth in the "Handling Guide for Semiconductor Devices," or "TOSHIBA Semiconductor Reliability Handbook" etc.
- The TOSHIBA products listed in this document are intended for usage in general electronics applications (computer, personal equipment, office equipment, measuring equipment, industrial robotics, domestic appliances, etc.). These TOSHIBA products are neither intended nor warranted for usage in equipment that requires extraordinarily high quality and/or reliability or a malfunction or failure of which may cause loss of human life or bodily injury ("Unintended Usage"). Unintended Usage include atomic energy control instruments, airplane or spaceship instruments, transportation instruments, traffic signal instruments, combustion control instruments, medical instruments, all types of safety devices, etc.. Unintended Usage of TOSHIBA products listed in this document shall be made at the customer's own risk.
- The products described in this document shall not be used or embedded to any downstream products of which manufacture, use and/or sale are prohibited under any applicable laws and regulations.
- The information contained herein is presented only as a guide for the applications of our products. No responsibility is assumed by TOSHIBA for any infringements of patents or other rights of the third parties which may result from its use. No license is granted by implication or otherwise under any patents or other rights of TOSHIBA or the third parties.
- GaAs(Gallium Arsenide) is used in this product. The dust or vapor is harmful to the human body. Do not break, cut, crush or dissolve chemically.
- Please contact your sales representative for product-by-product details in this document regarding RoHS compatibility. Please use these products in this document in compliance with all applicable laws and regulations that regulate the inclusion or use of controlled substances. Toshiba assumes no liability for damage or losses occurring as a result of noncompliance with applicable laws and regulations.

Mouser Electronics

Authorized Distributor

Click to View Pricing, Inventory, Delivery & Lifecycle Information:

[Toshiba:](#)

[TLP331\(BV,F\)](#) [TLP331\(F\)](#) [TLP332\(F\)](#)