

F3-24

Description:

The F3-24 Quick Pack small power transformer offers a significant reduction in size and weight over a standard transformer. This transformer can be used for a wide variety of applications. It is bobbin wound for reduced size and small operating space.

Electrical Specifications (@25C):

Maximum Power: 2.4VA

Input Voltage: 115VAC@50/60Hz

Output Voltage: 24VCT@0.1A

Construction:

Split bobbin non concentric winding eliminates costly electrostatic shielding. Termination is suitable for quick connects or soldering.

Safety:

UL Class B E53148



Dimensions:

A	B	C	D	E	F	G
1.187	1.75±.03	2.062	1.187	1.625	.187 Dia	.562

- Notes:**
1. Units: inches.
 2. Terminal size: .187" X 0.021".
 3. Weight: .25 lbs

Schematic:

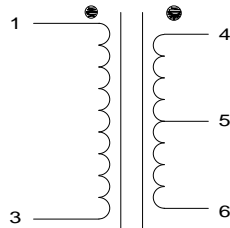

Input: 1 to 3

Output: 4 to 6

RoHS Compliance: As of manufacturing date February 2005, all standard products meet the requirements of 2002/95/EC, known as the RoHS initiative.

* Upon printing, this document is considered "uncontrolled". Please contact Triad Magnetics' website for the most current version.

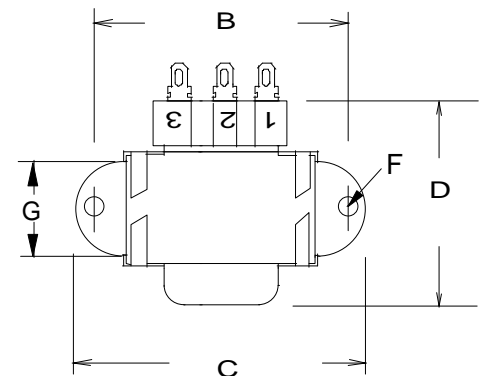
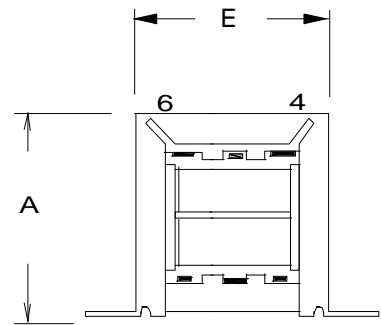
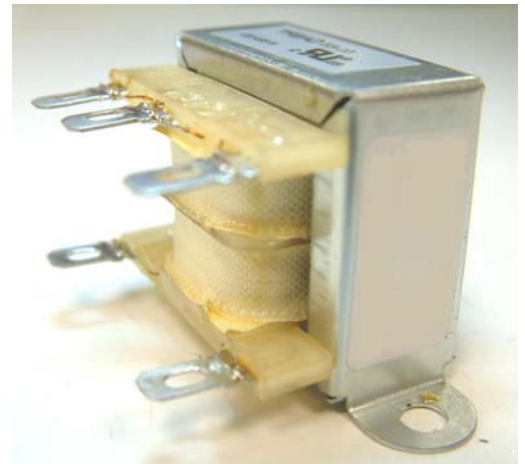

Mouser Electronics

Authorized Distributor

Click to View Pricing, Inventory, Delivery & Lifecycle Information:

[Triad Magnetics:](#)

[F3-24](#)